



**2SC3856**

**NPN PLANAR SILICON TRANSISTOR**

**AUDIO POWER AMPLIFIER  
DC TO DC CONVERTER**

- High Current Capability
- High Power Dissipation
- Complementary to 2SA1492

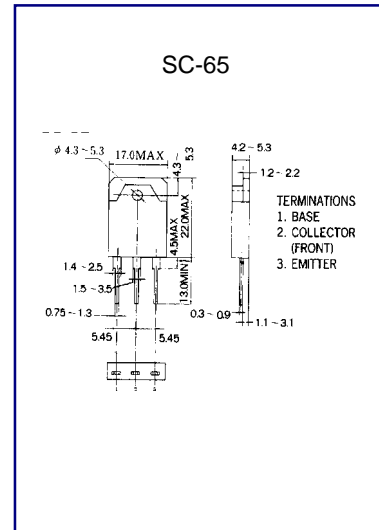

**ABSOLUTE MAXIMUM RATING (Ta=25°C)**

Characteristic	Symbol	Rating	Unit
Collector-Base Voltage	VCBO	180	V
Collector-Emitter Voltage	VCEO	180	V
Emitter-Base voltage	VEBO	6	V
Collector Current (DC)	IC	15	A
Collector Dissipation	PC	130	W
Junction Temperature	Tj	150	°C
Storage Temperature	Tstg	-55~150	°C

**ELECTRICAL CHARACTERISTICS (Ta=25°C)**

Characteristic	Symbol	Test Condition	Min	Typ	Max	Unit
Collector Base Breakdown Voltage	BVCBO	IC=5 mA IE=0	180			V
Collector Emitter Breakdown Voltage	BVCEO	IC=10 mA	180			V
Emitter Base Breakdown Voltage	BVEBO	RBE=∞	6			V
Collector Cutoff Current	ICBO	IE=4mA IC=0			0.1	mA
Emitter Cutoff Current	IEBO	VCB=90V IE=0			0.1	mA
*DC Current Gain	hFE1	VEB=4V IC=0	55		160	
DC Current Gain	hFE2	VCE=5V IC=1A	50			
Collector- Emitter Saturation Voltage	VCE(sat)	VCE=5V IC=3A IC=5A IB=0.5A			2.0	V