

# 2SC4833

## (TP5V40FS)

### 5A NPN

### OUTLINE DIMENSIONS

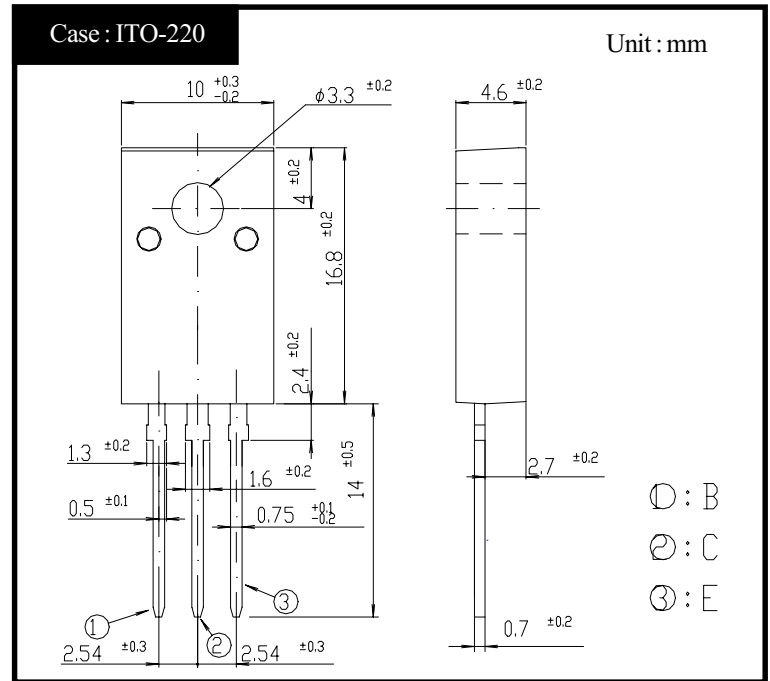

### RATINGS

#### ● Absolute Maximum Ratings

Item	Symbol	Conditions	Ratings	Unit
Storage Temperature	$T_{stg}$		-55~150	°C
Junction Temperature	$T_j$		150	°C
Collector to Base Voltage	$V_{CBO}$		500	V
Collector to Emitter Voltage	$V_{CEO}$		400	V
Emitter to Base Voltage	$V_{EBO}$		7	V
Collector Current DC	$I_C$		5	A
Collector Current Peak	$I_{CP}$		10	
Base Current DC	$I_B$		2	A
Base Current Peak	$I_{BP}$		4	
Total Transistor Dissipation	$P_T$	$T_c = 25^\circ\text{C}$	35	W
Dielectric Strength	$V_{dis}$	Terminals to case, AC 1 minute	2	kV
Mounting Torque	TOR	(Recommended torque : 0.3N·m)	0.5	N·m

#### ● Electrical Characteristics ( $T_c=25^\circ\text{C}$ )

Item	Symbol	Conditions	Ratings	Unit
Collector to Emitter Sustaining Voltage	$V_{CEO}(sus)$	$I_C = 0.1\text{A}$	Min 400	V
Collector Cutoff Current	$I_{CBO}$	At rated Voltage	Max 0.1	mA
	$I_{CEO}$		Max 0.1	
Emitter Cutoff Current	$I_{EBO}$	At rated Voltage	Max 0.1	mA
DC Current Gain	$h_{FE}$	$V_{CE} = 2\text{V}, I_C = 2.5\text{A}$	10~25	
	$h_{FEL}$	$V_{CE} = 2\text{V}, I_C = 1\text{mA}$	Min 10	
Collector to Emitter Saturation Voltage	$V_{CE}(sat)$	$I_C = 2.5\text{A}$	Max 1.0	V
Base to Emitter Saturation Voltage	$V_{BE}(sat)$	$I_B = 0.5\text{A}$	Max 1.5	V
Thermal Resistance	$\theta_{jc}$	Junction to case	Max 3.57	°C/W
Transition Frequency	$f_T$	$V_{CE} = 10\text{V}, I_C = 0.5\text{A}$	TYP 13	MHz
Turn on Time	$t_{on}$	$I_C = 2.5\text{A}$	Max 0.3	$\mu\text{s}$
Storage Time	$t_s$	$I_{B1} = 0.5\text{A}, I_{B2} = 1\text{A}$	Max 1.3	
Fall Time	$t_f$	$R_L = 60\Omega, V_{BB2} = 4\text{V}$	Max 0.1	

# 2SC4833

$h_{FE} - I_c$

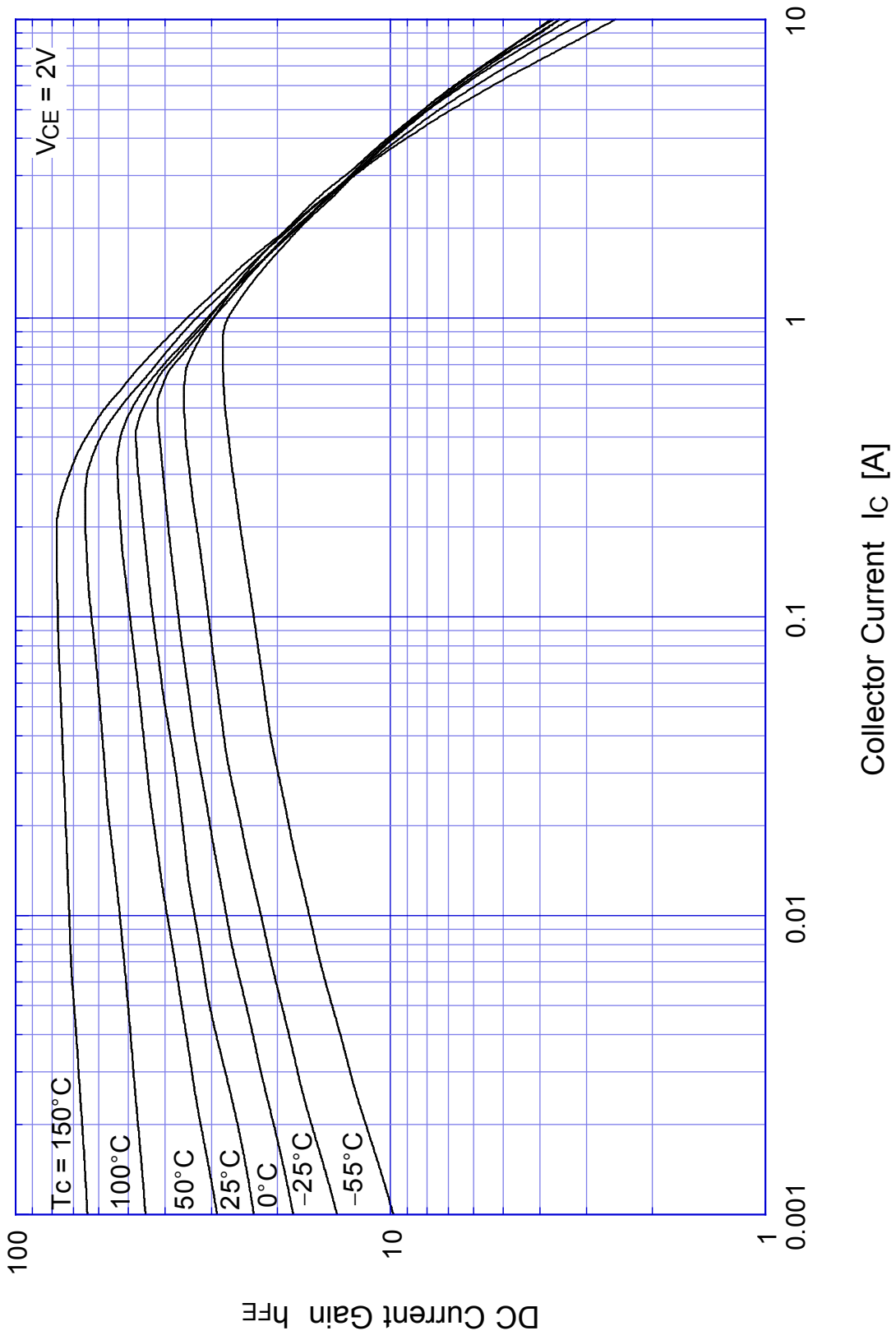

## 2SC4833 Saturation Voltage

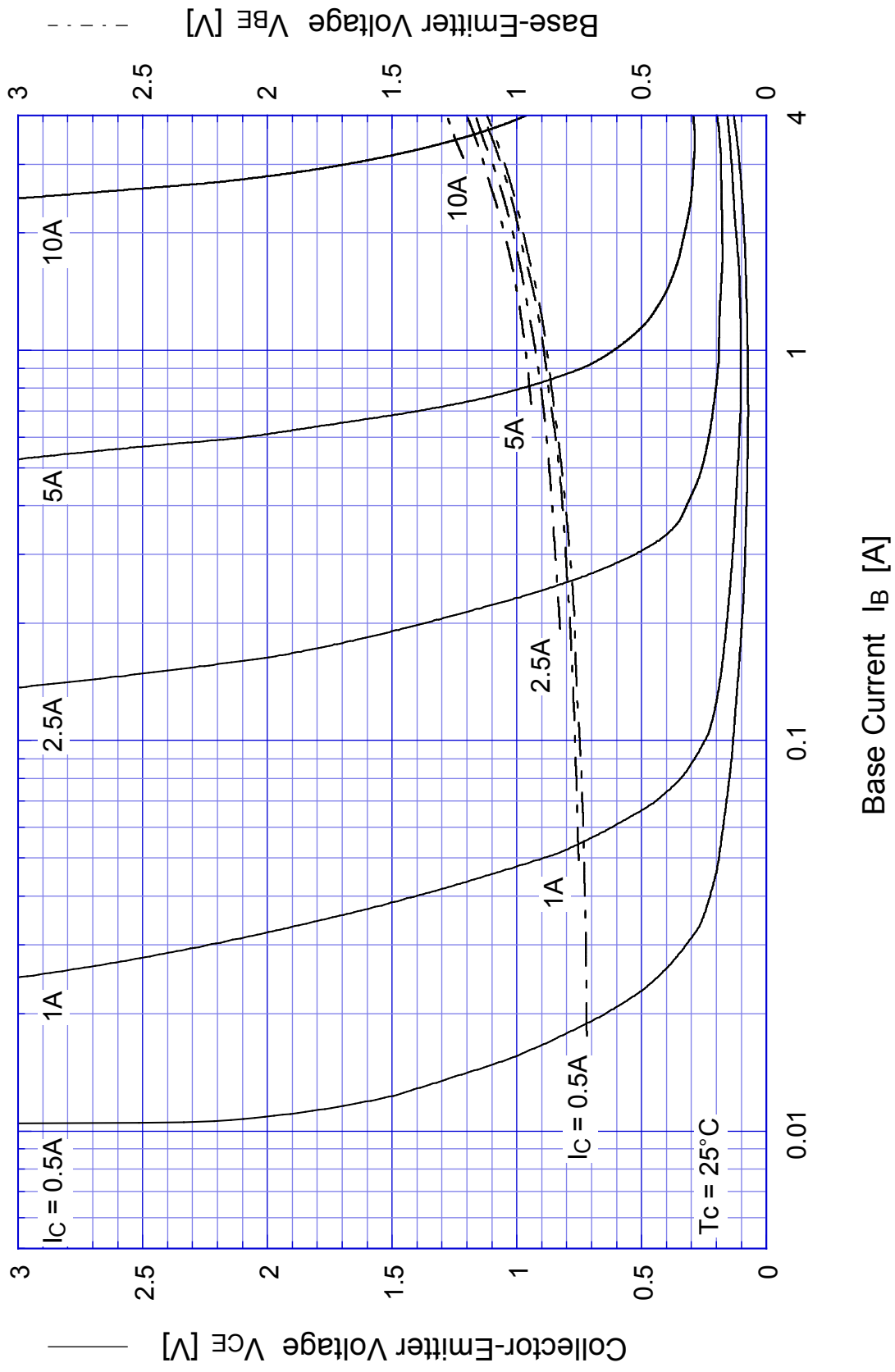

# 2SC4833

## Switching Time - $I_C$

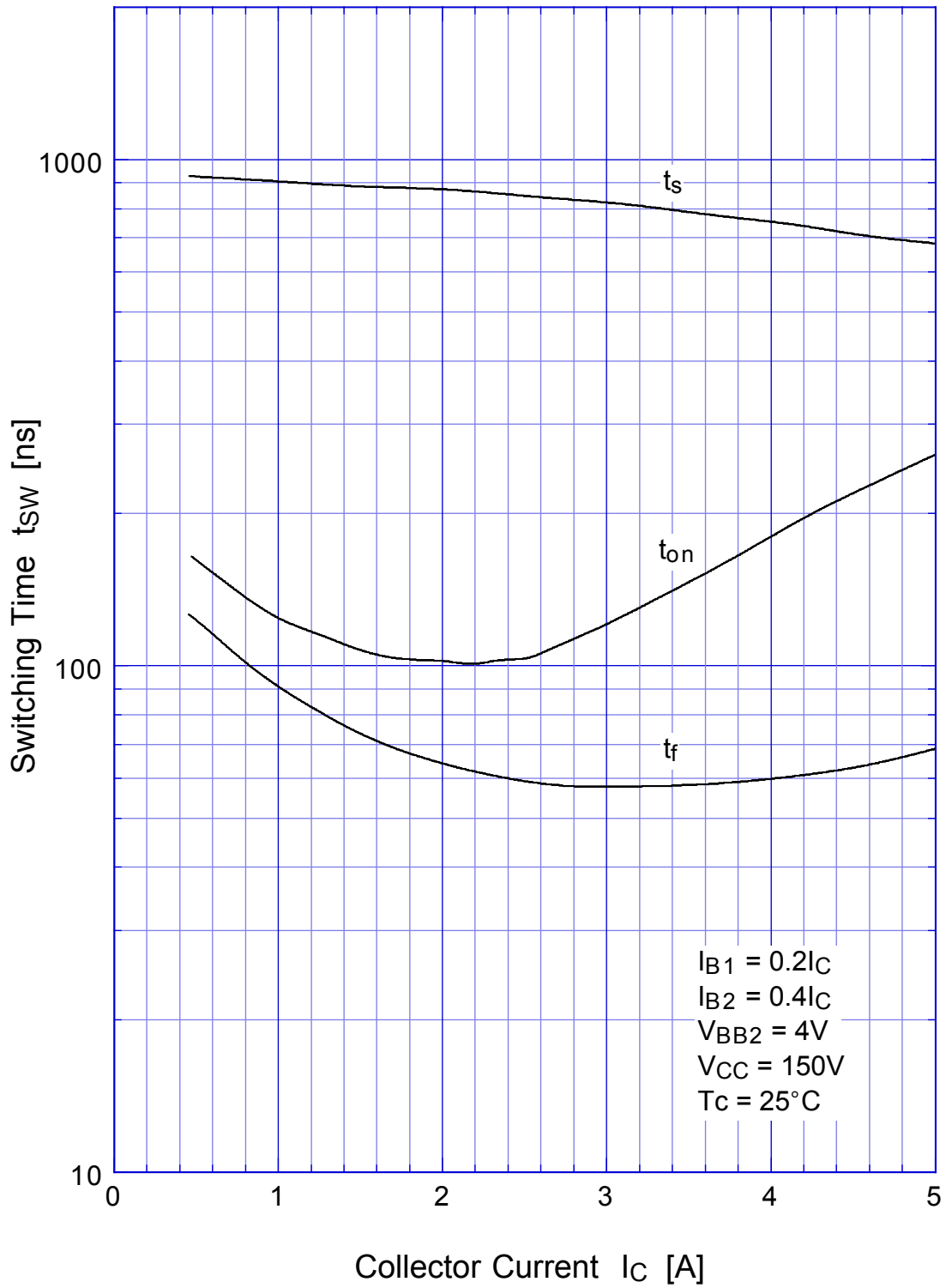

# 2SC4833

# Switching Time - Tc

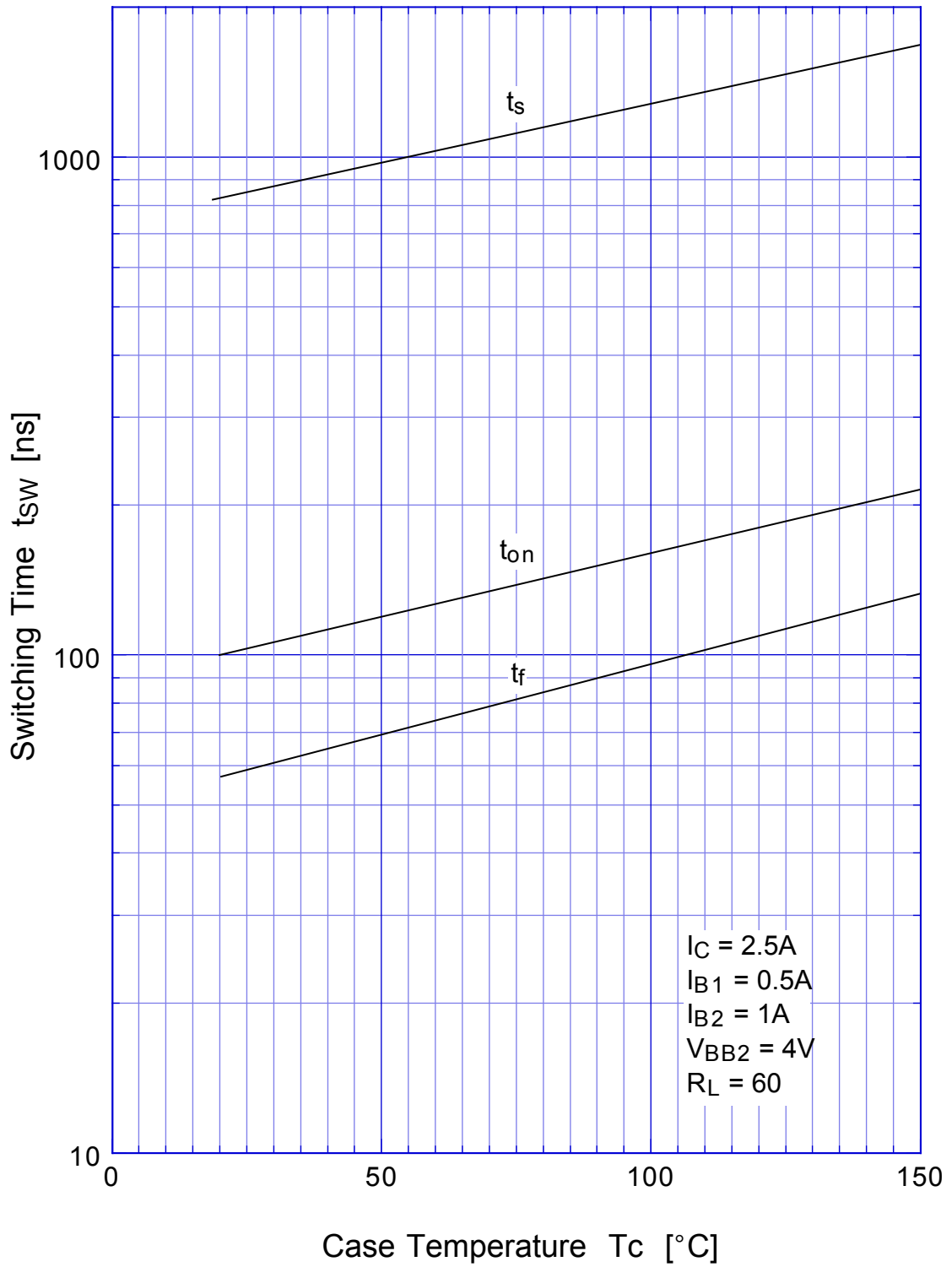

# 2SC4833

# Forward Bias SOA

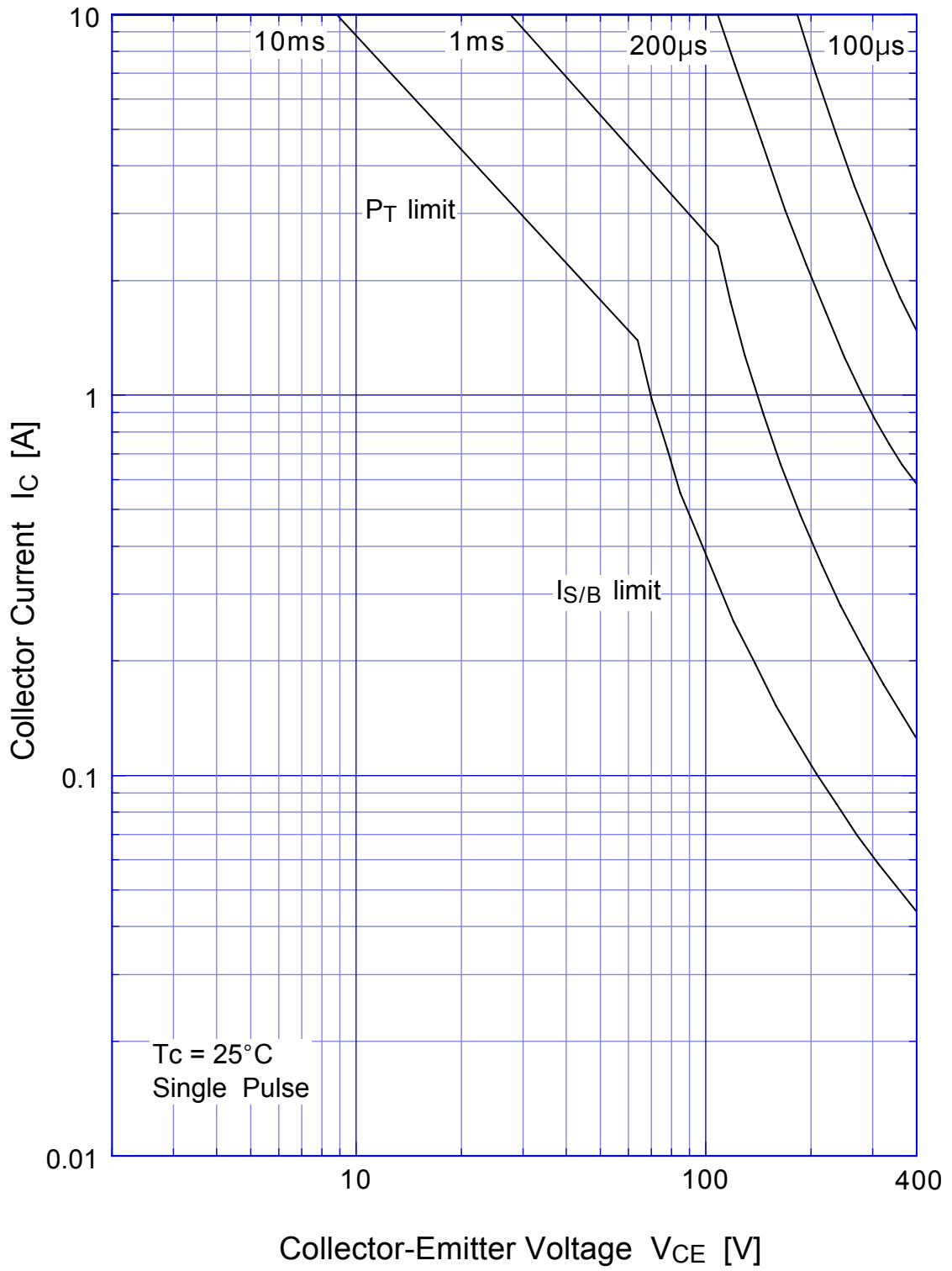

## 2SC4833 Collector Current Derating

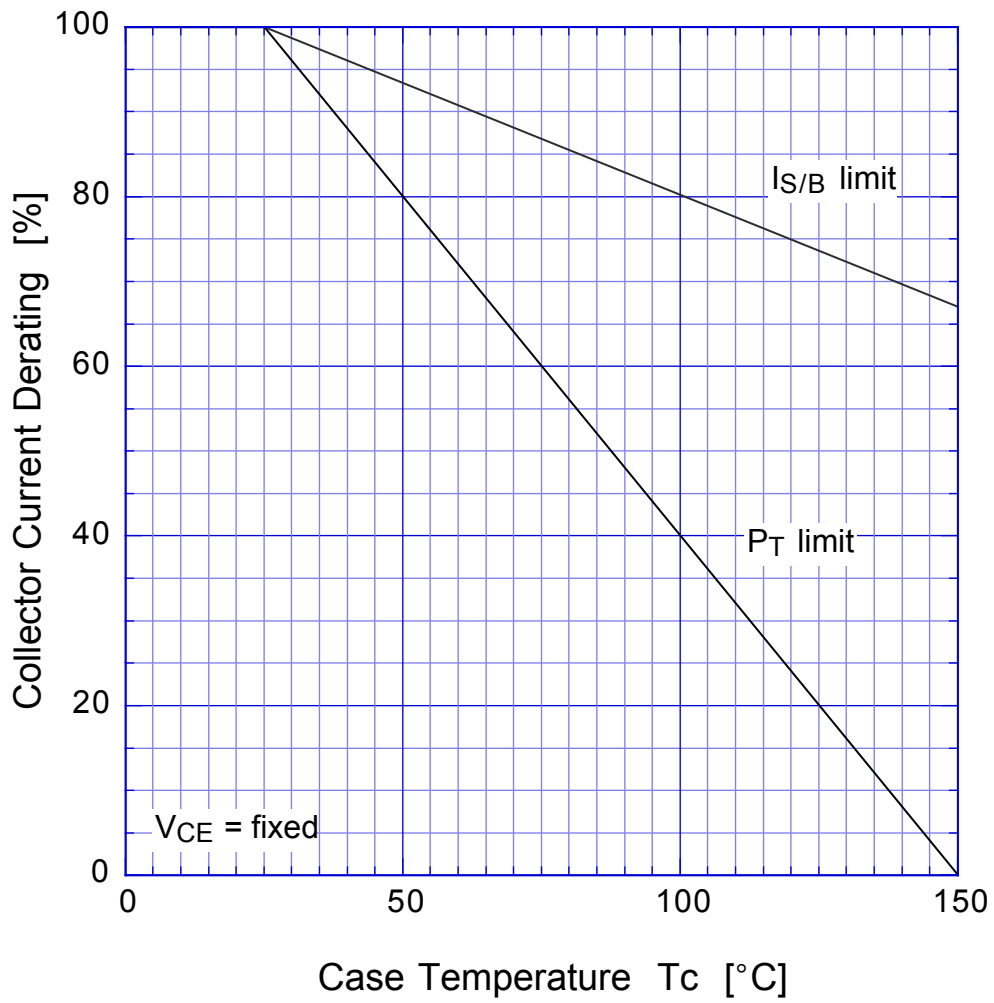

2SC4833

Reverse Bias SOA

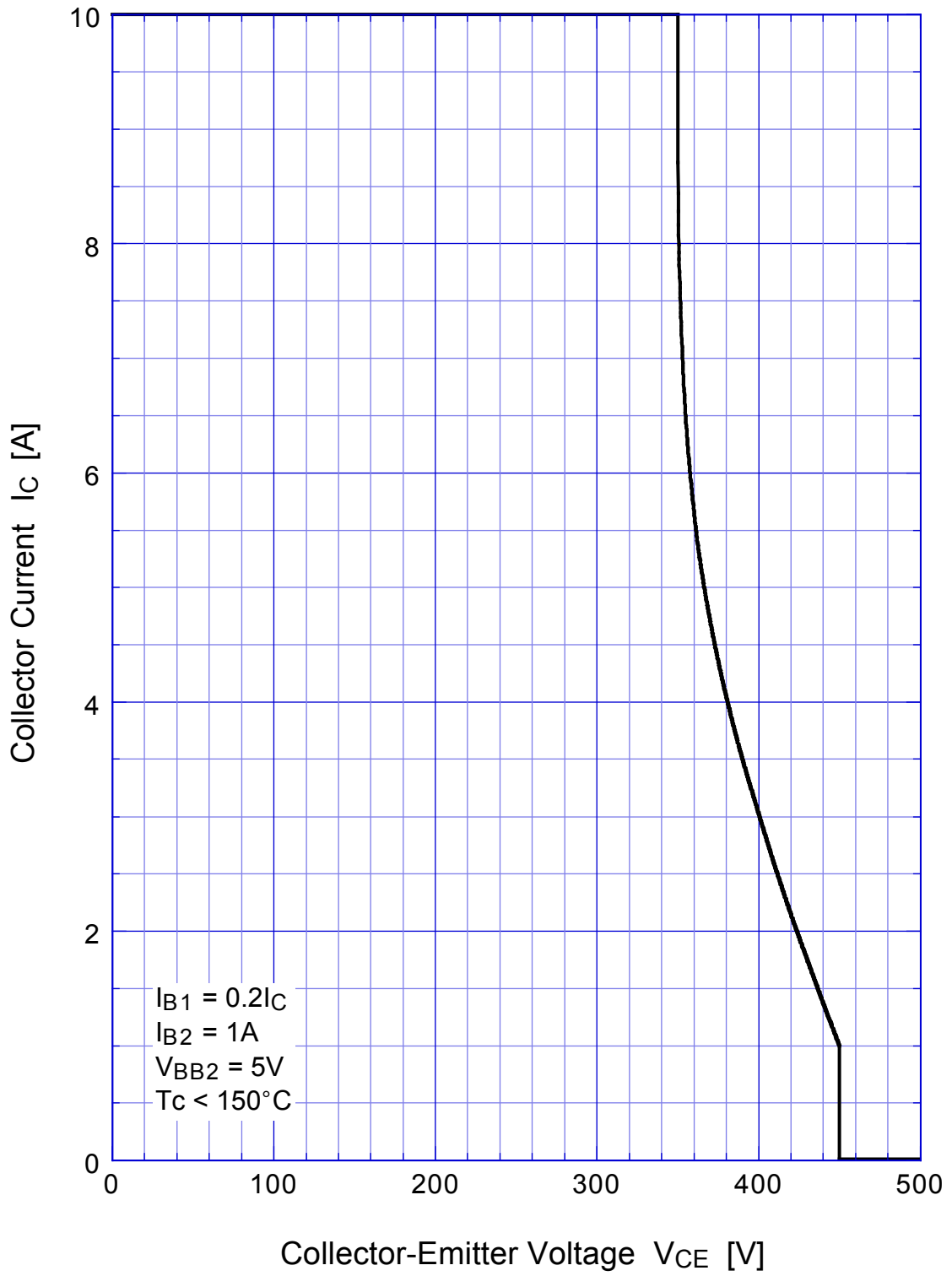



## 2SC4833 Transient Thermal Impedance

