

**2SC5551**

High-Frequency Medium-Output Amplifier Applications

Features

- High f_T : ($f_T=3.5\text{GHz}$ typ).
- Large current : ($I_C=300\text{mA}$).
- Large allowable collector dissipation (1.3W max).

Package Dimensions

unit:mm

2038A

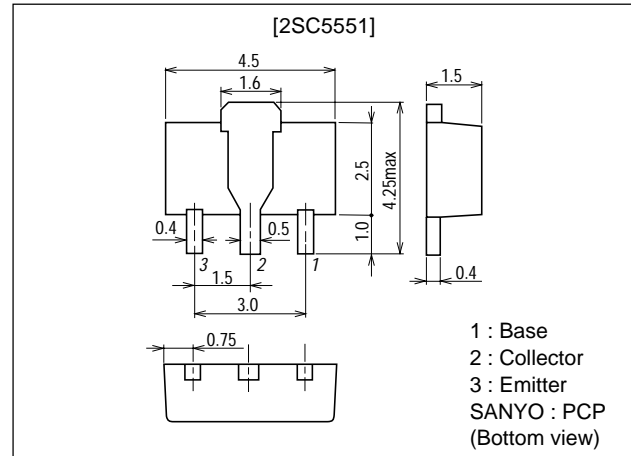

Specifications

Absolute Maximum Ratings at $T_a = 25^\circ\text{C}$

Parameter	Symbol	Conditions	Ratings	Unit
Collector-to-Base Voltage	V_{CBO}		40	V
Collector-to-Emitter Voltage	V_{CEO}		30	V
Emitter-to-Base Voltage	V_{EBO}		2	V
Collector Current	I_C		300	mA
Collector Current (pulse)	I_{CP}		600	mA
Collector Dissipation	P_C	Mounted on a ceramic board (250mm ² ×0.8mm)	1.3	W
Junction Temperature	T_J		150	°C
Storage Temperature	T_{stg}		-55 to +150	°C

Electrical Characteristics at $T_a = 25^\circ\text{C}$

Parameter	Symbol	Conditions	Ratings			Unit
			min	typ	max	
Collector Cutoff Current	I_{CBO}	$V_{CB}=20\text{V}, I_E=0$			1.0	μA
Emitter Cutoff Current	I_{EBO}	$V_{EB}=1\text{V}, I_C=0$			5.0	μA
DC Current Gain	h_{FE1}	$V_{CE}=5\text{V}, I_C=50\text{mA}$	90		270	
	h_{FE2}	$V_{CE}=5\text{V}, I_C=300\text{mA}$	20			

Continued on next page.

* : The 2SC5551 is classified by 50mA h_{FE} as follows :

Marking	EB	
	E	F
Rank		
h_{FE}	90 to 180	135 to 270

■ Any and all SANYO products described or contained herein do not have specifications that can handle applications that require extremely high levels of reliability, such as life-support systems, aircraft's control systems, or other applications whose failure can be reasonably expected to result in serious physical and/or material damage. Consult with your SANYO representative nearest you before using any SANYO products described or contained herein in such applications.

■ SANYO assumes no responsibility for equipment failures that result from using products at values that exceed, even momentarily, rated values (such as maximum ratings, operating condition ranges, or other parameters) listed in products specifications of any and all SANYO products described or contained herein.

SANYO Electric Co.,Ltd. Semiconductor Company

TOKYO OFFICE Tokyo Bldg., 1-10, 1 Chome, Ueno, Taito-ku, TOKYO, 110-8534 JAPAN

2SC5551

Continued from preceding page.

Parameter	Symbol	Conditions	Ratings			Unit
			min	typ	max	
Gain-Bandwidth Product	f_T	$V_{CE}=5V, I_C=50mA$		3.5		GHz
Output Capacitance	C_{ob}	$V_{CB}=10V, f=1MHz$		2.9	4.0	pF
Reverse Transfer Capacitance	C_{re}	$V_{CB}=10V, f=1MHz$		1.5		pF
Collector-to-Emitter Saturation Voltage	$V_{CE(sat)}$	$I_C=50mA, I_B=5mA$		0.15	0.3	V
Collector-to-Base Saturation Voltage	$V_{BE(sat)}$	$I_C=50mA, I_B=5mA$		0.9	1.2	V

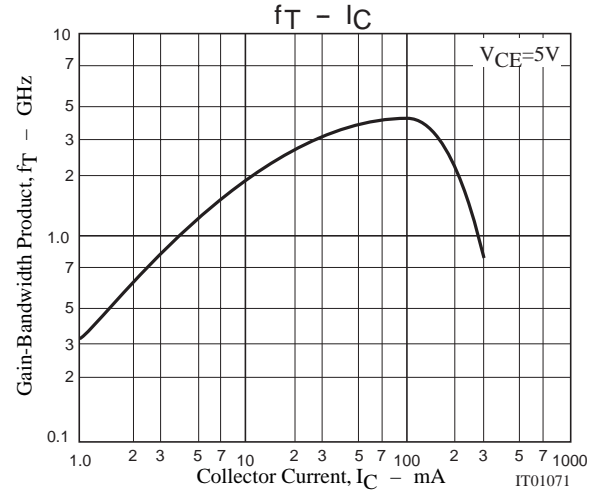
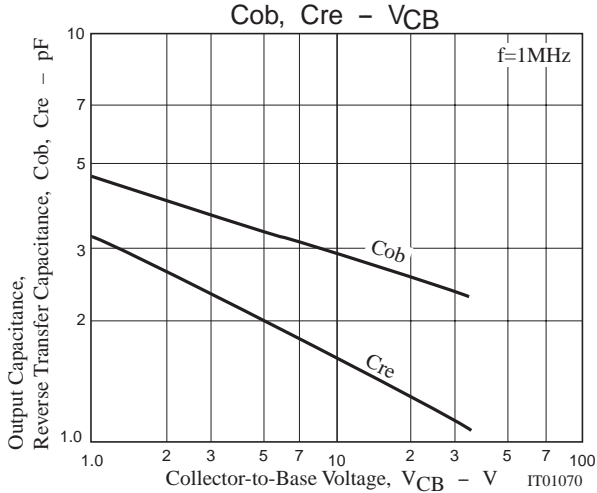
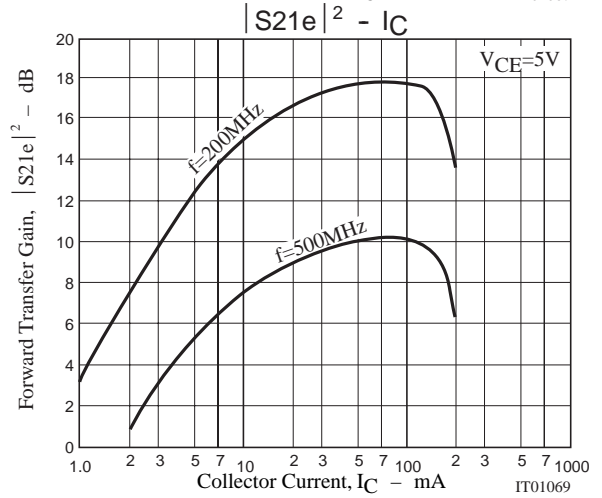
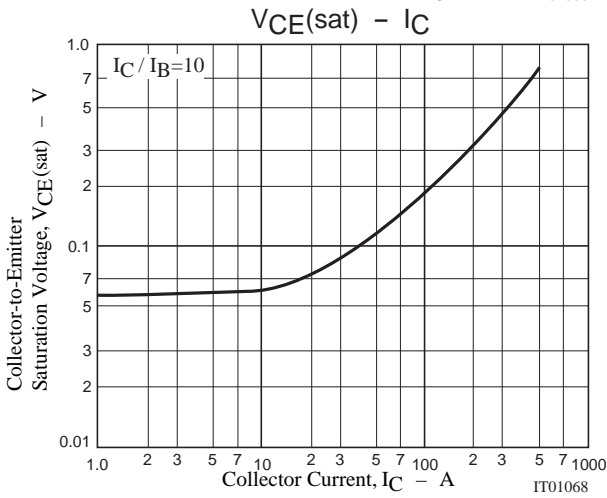
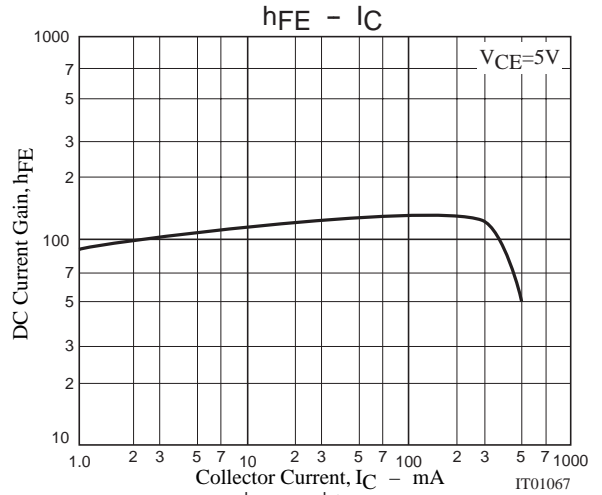
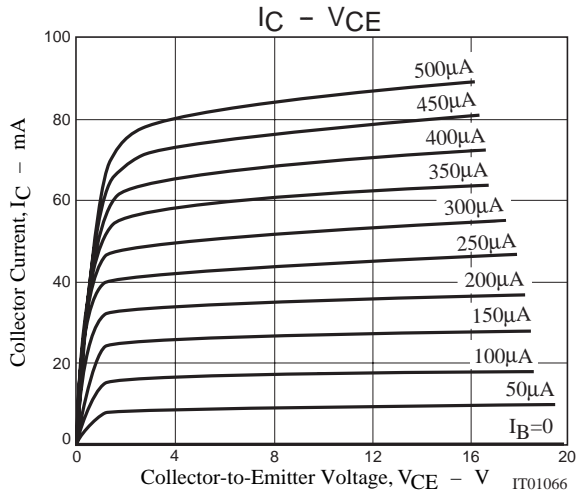

2SC5551

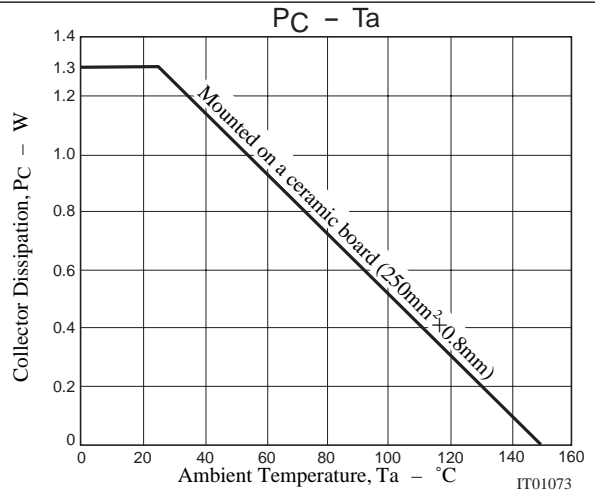
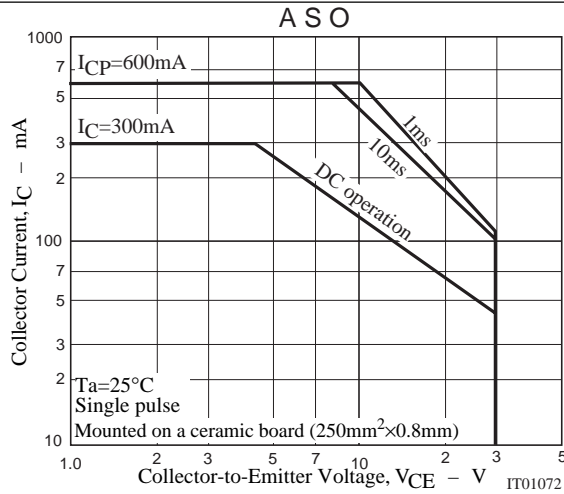

S Parameters (Common emitter)

$V_{CE}=5\text{V}$, $I_C=1\text{mA}$, $Z_0=50\Omega$

Freq (MHz)	$ S_{11} $	$\angle S_{11}$	$ S_{21} $	$\angle S_{21}$	$ S_{12} $	$\angle S_{12}$	$ S_{22} $	$\angle S_{22}$
100	0.941	-101.1	2.373	119.9	0.088	38.7	0.884	-17.8
200	0.859	-141.0	1.425	93.8	0.097	18.3	0.821	-25.2
300	0.829	-158.6	0.990	79.4	0.088	12.0	0.755	-33.8
400	0.831	-169.5	0.845	69.2	0.074	10.7	0.766	-41.9
500	0.840	-178.6	0.715	61.1	0.058	25.2	0.798	-49.9
600	0.816	172.3	0.638	54.7	0.055	51.6	0.790	-58.4
700	0.816	164.9	0.507	49.8	0.064	78.4	0.771	-66.7
800	0.814	157.3	0.466	47.0	0.098	87.3	0.813	-75.0
900	0.800	150.9	0.443	45.7	0.134	90.2	0.792	-82.8
1000	0.804	145.0	0.388	47.3	0.173	92.2	0.782	-90.0

$V_{CE}=5\text{V}$, $I_C=5\text{mA}$, $Z_0=50\Omega$

Freq (MHz)	$ S_{11} $	$\angle S_{11}$	$ S_{21} $	$\angle S_{21}$	$ S_{12} $	$\angle S_{12}$	$ S_{22} $	$\angle S_{22}$
100	0.803	-114.9	7.414	115.7	0.068	41.3	0.635	-36.3
200	0.724	-151.3	4.172	93.7	0.076	31.5	0.472	-41.7
300	0.701	-165.9	2.952	82.3	0.078	35.0	0.431	-45.4
400	0.700	-175.1	2.286	73.9	0.082	42.9	0.432	-50.2
500	0.693	177.1	1.857	66.6	0.091	51.9	0.437	-56.6
600	0.689	170.2	1.559	60.0	0.100	58.6	0.443	-63.4
700	0.695	164.3	1.371	54.3	0.117	64.7	0.451	-70.3
800	0.691	158.3	1.174	48.8	0.137	69.1	0.463	-77.3
900	0.693	153.0	1.067	44.5	0.161	71.4	0.479	-84.1
1000	0.705	147.9	0.988	40.9	0.189	72.3	0.496	-90.3

$V_{CE}=5\text{V}$, $I_C=10\text{mA}$, $Z_0=50\Omega$

Freq (MHz)	$ S_{11} $	$\angle S_{11}$	$ S_{21} $	$\angle S_{21}$	$ S_{12} $	$\angle S_{12}$	$ S_{22} $	$\angle S_{22}$
100	0.718	-127.2	10.489	111.3	0.059	43.0	0.509	-50.8
200	0.658	-157.9	5.747	92.2	0.069	41.0	0.329	-58.8
300	0.639	-170.4	3.882	82.7	0.079	47.7	0.286	-61.0
400	0.632	-178.7	2.954	75.4	0.092	52.8	0.271	-65.2
500	0.628	174.6	2.405	68.8	0.107	57.4	0.273	-70.5
600	0.627	168.5	2.040	62.8	0.124	60.5	0.280	-76.9
700	0.626	162.9	1.778	57.4	0.143	62.9	0.296	-81.6
800	0.629	157.4	1.571	52.3	0.162	64.7	0.306	-87.9
900	0.631	152.7	1.405	47.9	0.185	64.8	0.318	-93.9
1000	0.633	148.0	1.292	43.7	0.209	64.8	0.339	-98.4

2SC5551

$V_{CE}=5V, I_C=20mA, Z_O=50\Omega$

Freq (MHz)	$ S_{11} $	$\angle S_{11}$	$ S_{21} $	$\angle S_{21}$	$ S_{12} $	$\angle S_{12}$	$ S_{22} $	$\angle S_{22}$
100	0.653	-137.8	13.042	107.6	0.051	46.8	0.423	-68.5
200	0.608	-163.6	6.841	91.3	0.067	50.0	0.252	-84.4
300	0.591	-174.4	4.610	83.0	0.083	56.1	0.201	-91.5
400	0.584	178.4	3.504	76.4	0.102	59.2	0.186	-95.7
500	0.580	172.2	2.852	70.5	0.122	61.1	0.186	-100.2
600	0.579	166.7	2.427	65.3	0.144	62.2	0.195	-104.0
700	0.576	161.2	2.100	60.1	0.165	62.4	0.205	-107.4
800	0.576	156.1	1.871	55.5	0.186	62.3	0.215	-111.9
900	0.578	151.6	1.684	51.1	0.209	61.5	0.229	-115.4
1000	0.581	147.2	1.542	47.2	0.231	60.4	0.241	-118.7

$V_{CE}=5V, I_C=50mA, Z_O=50\Omega$

Freq (MHz)	$ S_{11} $	$\angle S_{11}$	$ S_{21} $	$\angle S_{21}$	$ S_{12} $	$\angle S_{12}$	$ S_{22} $	$\angle S_{22}$
100	0.611	-147.0	14.987	104.6	0.047	51.3	0.371	-88.8
200	0.573	-168.9	7.700	90.4	0.066	57.3	0.241	-115.9
300	0.556	-177.8	5.174	83.1	0.088	61.8	0.205	-128.4
400	0.551	175.7	3.932	77.4	0.111	63.4	0.192	-135.3
500	0.545	169.9	3.202	72.0	0.136	63.8	0.190	-138.5
600	0.542	164.5	2.710	67.1	0.160	63.3	0.195	-140.7
700	0.540	159.3	2.347	62.7	0.184	62.3	0.200	-142.5
800	0.537	154.2	2.096	58.4	0.207	61.1	0.207	-144.8
900	0.540	149.9	1.882	54.4	0.230	59.4	0.215	-146.8
1000	0.541	145.6	1.729	50.5	0.254	57.9	0.223	-148.4

$V_{CE}=5V, I_C=100mA, Z_O=50\Omega$

Freq (MHz)	$ S_{11} $	$\angle S_{11}$	$ S_{21} $	$\angle S_{21}$	$ S_{12} $	$\angle S_{12}$	$ S_{22} $	$\angle S_{22}$
100	0.606	-159.9	15.141	100.1	0.046	50.9	0.369	-102.2
200	0.572	-174.1	7.687	88.9	0.066	59.1	0.254	-129.7
300	0.558	179.3	5.186	82.6	0.090	63.0	0.223	-142.0
400	0.551	174.1	3.952	77.1	0.116	64.3	0.213	-148.5
500	0.542	168.6	3.229	72.1	0.141	64.4	0.210	-151.5
600	0.536	163.0	2.738	67.4	0.167	63.3	0.213	-153.0
700	0.531	157.4	2.375	62.6	0.192	62.0	0.219	-154.5
800	0.528	152.2	2.114	58.5	0.215	60.3	0.226	-156.5
900	0.529	147.7	1.900	54.8	0.239	58.5	0.234	-158.6
1000	0.530	143.5	1.737	51.1	0.262	57.0	0.239	-160.3

- Specifications of any and all SANYO products described or contained herein stipulate the performance, characteristics, and functions of the described products in the independent state, and are not guarantees of the performance, characteristics, and functions of the described products as mounted in the customer's products or equipment. To verify symptoms and states that cannot be evaluated in an independent device, the customer should always evaluate and test devices mounted in the customer's products or equipment.
- SANYO Electric Co., Ltd. strives to supply high-quality high-reliability products. However, any and all semiconductor products fail with some probability. It is possible that these probabilistic failures could give rise to accidents or events that could endanger human lives, that could give rise to smoke or fire, or that could cause damage to other property. When designing equipment, adopt safety measures so that these kinds of accidents or events cannot occur. Such measures include but are not limited to protective circuits and error prevention circuits for safe design, redundant design, and structural design.
- In the event that any or all SANYO products(including technical data, services) described or contained herein are controlled under any of applicable local export control laws and regulations, such products must not be exported without obtaining the export license from the authorities concerned in accordance with the above law.
- No part of this publication may be reproduced or transmitted in any form or by any means, electronic or mechanical, including photocopying and recording, or any information storage or retrieval system, or otherwise, without the prior written permission of SANYO Electric Co., Ltd.
- Any and all information described or contained herein are subject to change without notice due to product/technology improvement, etc. When designing equipment, refer to the "Delivery Specification" for the SANYO product that you intend to use.
- Information (including circuit diagrams and circuit parameters) herein is for example only ; it is not guaranteed for volume production. SANYO believes information herein is accurate and reliable, but no guarantees are made or implied regarding its use or any infringements of intellectual property rights or other rights of third parties.

This catalog provides information as of February, 2000. Specifications and information herein are subject to change without notice.