

---

# 2SK1934

Silicon N-Channel MOS FET

# HITACHI

---

## Application

High speed power switching

## Features

- Low on-resistance
- High speed switching
- No secondary breakdown
- Suitable for Switching regulator

## Outline

TO-3P

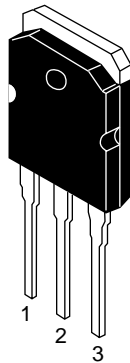
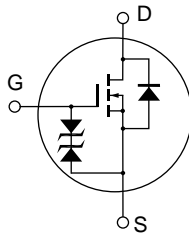

1. Gate
2. Drain  
(Flange)
3. Source

**Absolute Maximum Ratings** ( $T_a = 25^\circ\text{C}$ )

<b>Item</b>	<b>Symbol</b>	<b>Ratings</b>	<b>Unit</b>
Drain to source voltage	$V_{\text{DSS}}$	1000	V
Gate to source voltage	$V_{\text{GSS}}$	$\pm 30$	V
Drain current	$I_{\text{D}}$	8	A
Drain peak current	$I_{\text{D(pulse)}}^{*1}$	24	A
Body to drain diode reverse drain current	$I_{\text{DR}}$	8	A
Channel dissipation	$P_{\text{ch}}^{*2}$	150	W
Channel temperature	$T_{\text{ch}}$	150	$^\circ\text{C}$
Storage temperature	$T_{\text{stg}}$	-55 to +150	$^\circ\text{C}$

Notes 1.  $PW = 10 \mu\text{s}$ , duty cycle = 1 %  
2. Value at  $T_c = 25^\circ\text{C}$

## Electrical Characteristics (Ta = 25°C)

Item	Symbol	Min	Typ	Max	Unit	Test conditions
Drain to source breakdown voltage	$V_{(BR)DSS}$	1000	—	—	V	$I_D = 10 \text{ mA}$ , $V_{GS} = 0$
Gate to source breakdown voltage	$V_{(BR)GSS}$	±30	—	—	V	$I_G = \pm 100 \text{ } \mu\text{A}$ , $V_{DS} = 0$
Gate to source leak current	$I_{GSS}$	—	—	±10	μA	$V_{GS} = \pm 25 \text{ V}$ , $V_{DS} = 0$
Zero gate voltage drain current	$I_{DSS}$	—	—	250	μA	$V_{DS} = 800 \text{ V}$ , $V_{GS} = 0$
Gate to source cutoff voltage	$V_{GS(off)}$	2.0	—	3.0	V	$I_D = 1 \text{ mA}$ , $V_{DS} = 10 \text{ V}$
Static drain to source on state resistance	$R_{DS(on)}$	—	1.2	1.6		$I_D = 4 \text{ A}$ $V_{GS} = 10 \text{ V}^{*1}$
Forward transfer admittance	$ y_{fs} $	4	6	—	S	$I_D = 4 \text{ A}$ $V_{DS} = 20 \text{ V}^{*1}$
Input capacitance	$C_{iss}$	—	2690	—	pF	$V_{DS} = 10 \text{ V}$
Output capacitance	$C_{oss}$	—	920	—	pF	$V_{GS} = 0$
Reverse transfer capacitance	$C_{rss}$	—	375	—	pF	$f = 1 \text{ MHz}$
Turn-on delay time	$t_{d(on)}$	—	35	—	ns	$I_D = 4 \text{ A}$
Rise time	$t_r$	—	135	—	ns	$V_{GS} = 10 \text{ V}$
Turn-off delay time	$t_{d(off)}$	—	300	—	ns	$R_L = 7.5$
Fall time	$t_f$	—	205	—	ns	
Body to drain diode forward voltage	$V_{DF}$	—	0.9	—	V	$I_F = 8 \text{ A}$ , $V_{GS} = 0$
Body to drain diode reverse recovery time	$t_{rr}$	—	1600	—	μs	$I_F = 8 \text{ A}$ , $V_{GS} = 0$ , $di_F / dt = 100 \text{ A} / \mu\text{s}$

Note 1. Pulse Test

Power vs. Temperature Derating

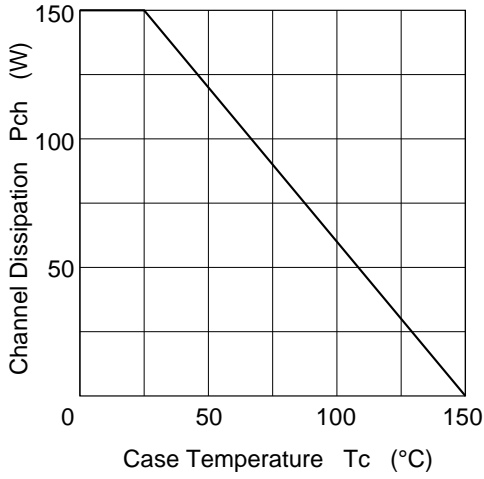

Maximum Safe Operation Area

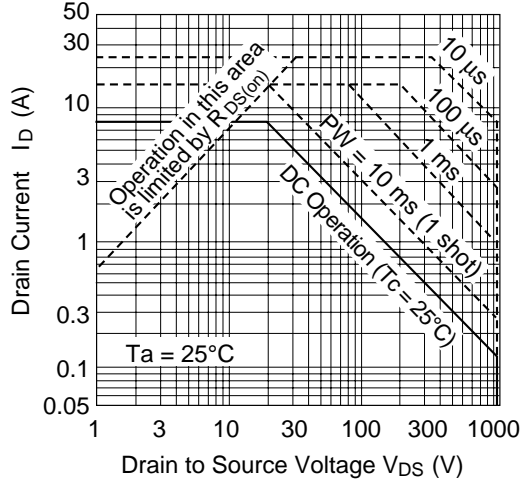

Typical Output Characteristics

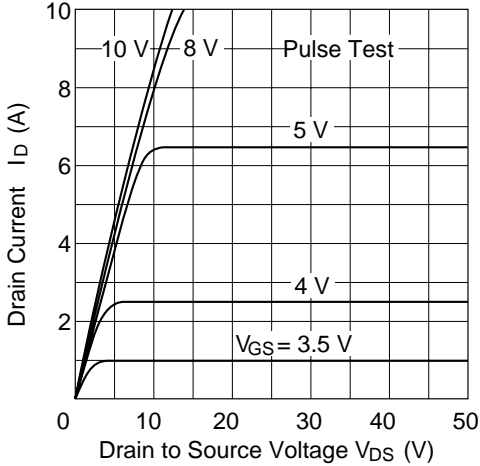

Typical Transfer Characteristics

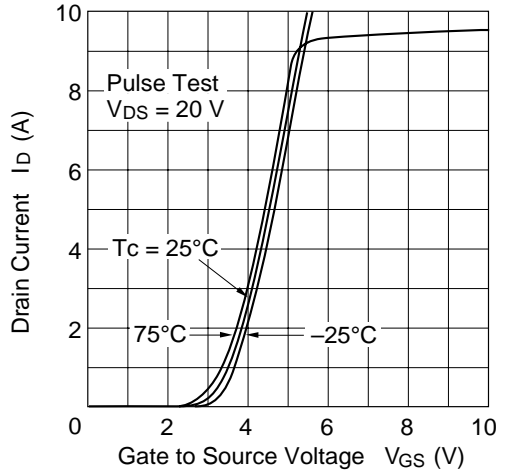

Drain to Source Saturation Voltage vs. Gate to Source Voltage

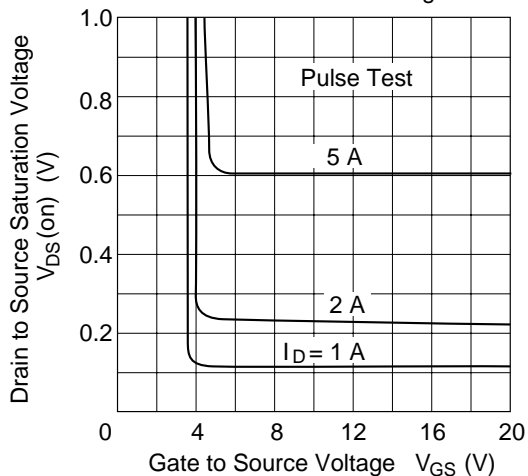

Static Drain to Source on State Resistance vs. Drain Current

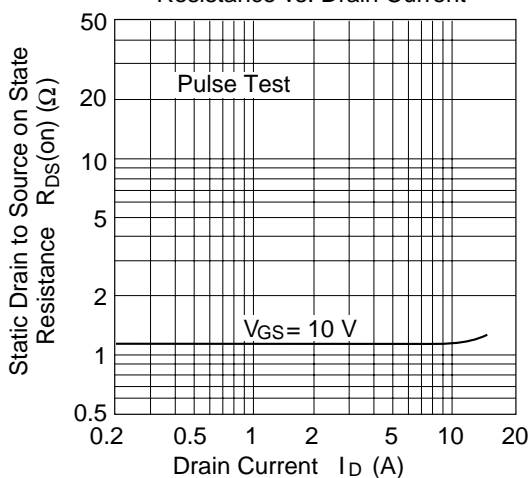

Static Drain to Source on State Resistance vs. Temperature

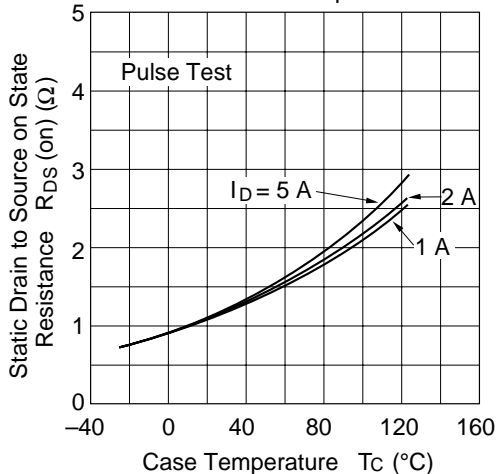

Forward Transfer Admittance vs. Drain Current

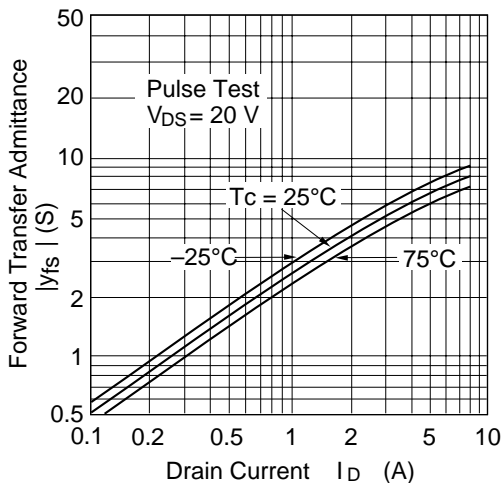

Body to Drain Diode Reverse Recovery Time

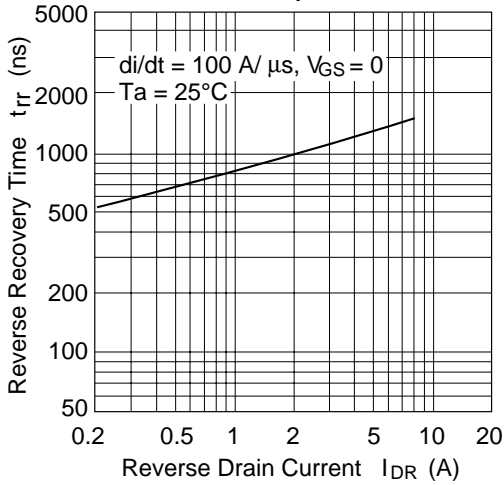

Typical Capacitance vs. Drain to Source Voltage

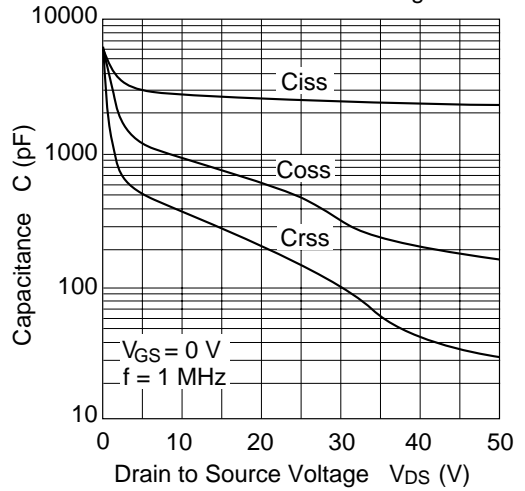

Dynamic Input Characteristics

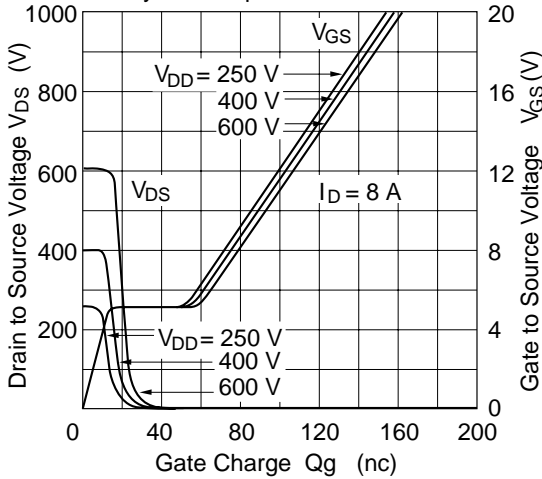

Switching Characteristics

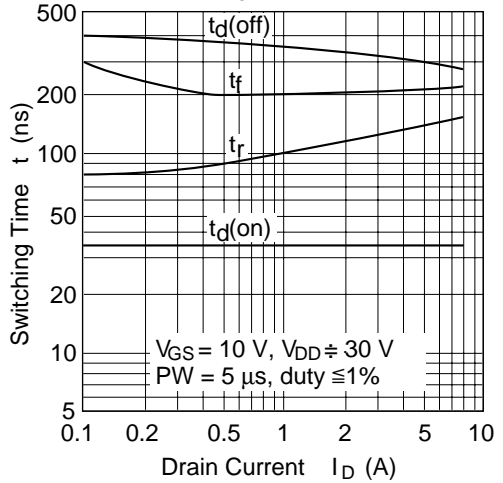

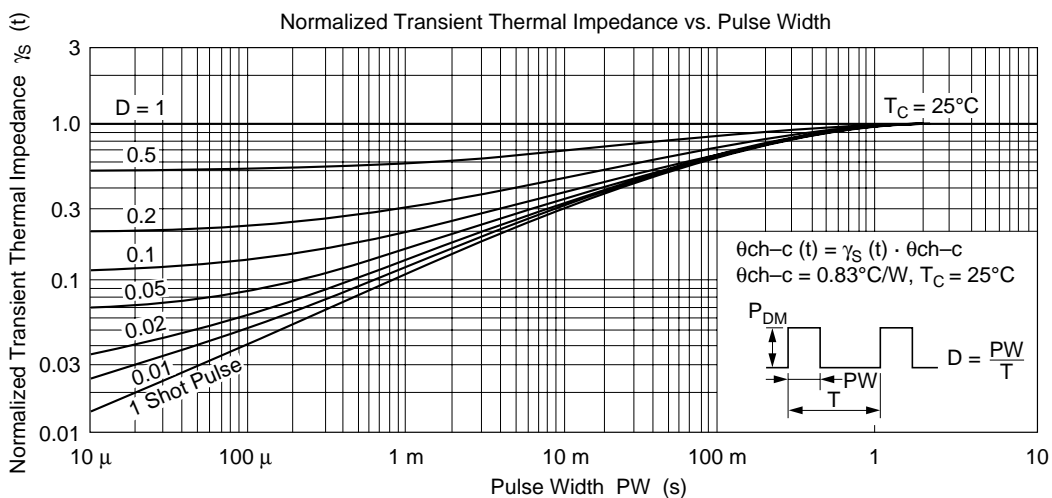
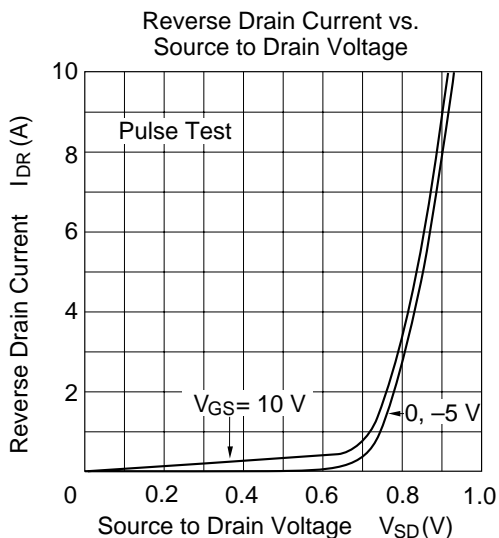

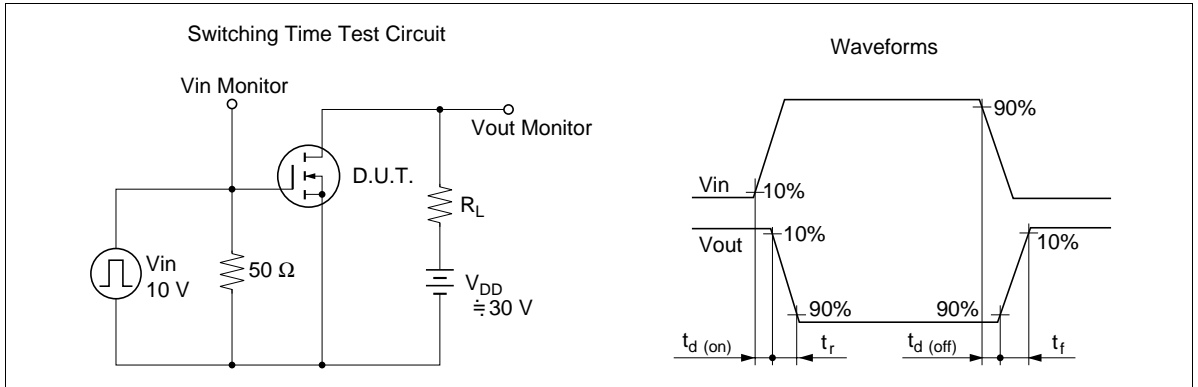



When using this document, keep the following in mind:

1. This document may, wholly or partially, be subject to change without notice.
2. All rights are reserved: No one is permitted to reproduce or duplicate, in any form, the whole or part of this document without Hitachi's permission.
3. Hitachi will not be held responsible for any damage to the user that may result from accidents or any other reasons during operation of the user's unit according to this document.
4. Circuitry and other examples described herein are meant merely to indicate the characteristics and performance of Hitachi's semiconductor products. Hitachi assumes no responsibility for any intellectual property claims or other problems that may result from applications based on the examples described herein.
5. No license is granted by implication or otherwise under any patents or other rights of any third party or Hitachi, Ltd.
6. **MEDICAL APPLICATIONS:** Hitachi's products are not authorized for use in **MEDICAL APPLICATIONS** without the written consent of the appropriate officer of Hitachi's sales company. Such use includes, but is not limited to, use in life support systems. Buyers of Hitachi's products are requested to notify the relevant Hitachi sales offices when planning to use the products in **MEDICAL APPLICATIONS**.

# HITACHI

## Hitachi, Ltd.

Semiconductor & IC Div.  
Nippon Bldg., 2-6-2, Ohte-machi, Chiyoda-ku, Tokyo 100, Japan  
Tel: Tokyo (03) 3270-2111  
Fax: (03) 3270-5109

### For further information write to:

Hitachi America, Ltd.  
Semiconductor & IC Div.  
2000 Sierra Point Parkway  
Brisbane, CA. 94005-1835  
U S A  
Tel: 415-589-8300  
Fax: 415-583-4207

Hitachi Europe GmbH  
Electronic Components Group  
Continental Europe  
Dornacher Straße 3  
D-85622 Feldkirchen  
München  
Tel: 089-9 91 80-0  
Fax: 089-9 29 30 00

Hitachi Europe Ltd.  
Electronic Components Div.  
Northern Europe Headquarters  
Whitebrook Park  
Lower Cookham Road  
Maidenhead  
Berkshire SL6 8YA  
United Kingdom  
Tel: 0628-585000  
Fax: 0628-778322

Hitachi Asia Pte. Ltd.  
16 Collyer Quay #20-00  
Hitachi Tower  
Singapore 0104  
Tel: 535-2100  
Fax: 535-1533

Hitachi Asia (Hong Kong) Ltd.  
Unit 706, North Tower,  
World Finance Centre,  
Harbour City, Canton Road  
Tsim Sha Tsui, Kowloon  
Hong Kong  
Tel: 27359218  
Fax: 27306071