

NPN General Purpose Transistor

BC848BW / BC848B / BC848C

●Features

- 1) V_{CE0} minimum is 30V ($I_C=1mA$)
- 2) Complements the BC858B / BC858BW.

●Package, marking and packaging specifications

Part No.	BC848BW	BC848B	BC848C
Packaging type	UMT3	SST3	SST3
Marking	G1K	G1K	G1L
Code	T106	T116	T116
Basic ordering unit (pieces)	3000	3000	3000

●Absolute maximum ratings ($T_a=25^\circ C$)

Parameter	Symbol	Limits	Unit
Collector-base voltage	V_{CBO}	30	V
Collector-emitter voltage	V_{CEO}	30	V
Emitter-base voltage	V_{EB0}	5	V
Collector current	I_C	0.1	A
Collector power dissipation	P_C	0.2	W
		0.35	
Junction temperature	T_J	150	$^\circ C$
Storage temperature	T_{stg}	$-55 \sim +150$	$^\circ C$

* When mounted on a 7 x 5 x 0.6 mm ceramic board.

●External dimensions (Units : mm)

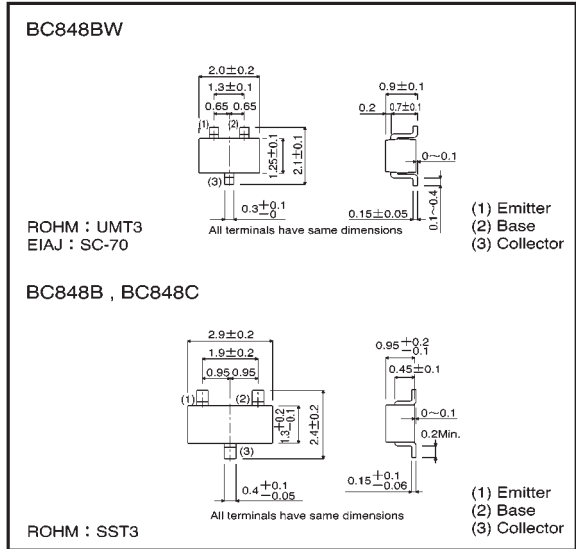

●Electrical characteristics ($T_a=25^\circ C$)

Parameter	Symbol	Min.	Typ.	Max.	Unit	Conditions
Collector-base breakdown voltage	BV_{CBO}	30	—	—	V	$I_C=50 \mu A$
Collector-emitter breakdown voltage	BV_{CEO}	30	—	—	V	$I_C=1mA$
Emitter-base breakdown voltage	BV_{EB0}	5	—	—	V	$I_E=50 \mu A$
Collector cutoff current	I_{CBO}	—	—	15	μA	$V_{CB}=30V$
		—	—	5		$V_{CB}=30V, T_a=150^\circ C$
Collector-emitter saturation voltage	$V_{CE(sat)}$	—	—	0.25	V	$I_C/I_E=10mA/0.5mA$
		—	—	0.6		$I_C/I_E=100mA/5mA$
Base-emitter saturation voltage	$V_{BE(on)}$	0.58	—	0.77	V	$V_{CE}/I_C=5V/10mA$
DC current transfer ratio	h_{FE}	200	—	450	—	$V_{CE}/I_C=5V/2mA$ (BC848B/BW)
		420	—	800		$V_{CE}/I_C=5V/2mA$ (BC848C)
Transition frequency	f_T	—	200	—	MHz	$V_{CE}=5V, I_E=-20mA, f=100MHz$
Collector output capacitance	C_{ob}	—	3	—	pF	$V_{CB}=10V, I_E=0, f=1MHz$
Collector output capacitance	C_{ib}	—	8	—	pF	$V_{EB}=0.5V, I_E=0, f=1MHz$

(SPEC-C22)

●Electrical characteristic curves

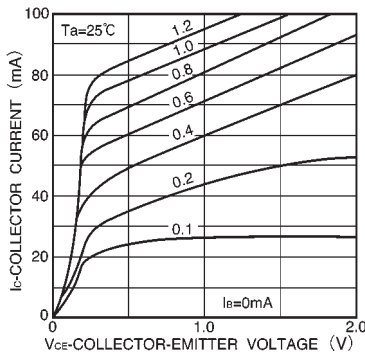

Fig.1 Grounded emitter output characteristics (I)

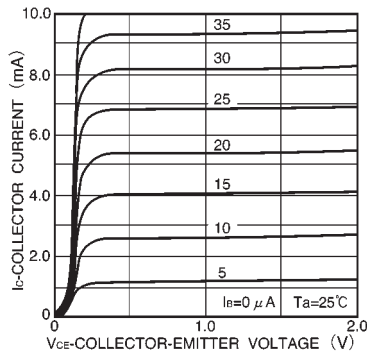

Fig.2 Grounded emitter output characteristics (II)

(SPEC-C22)

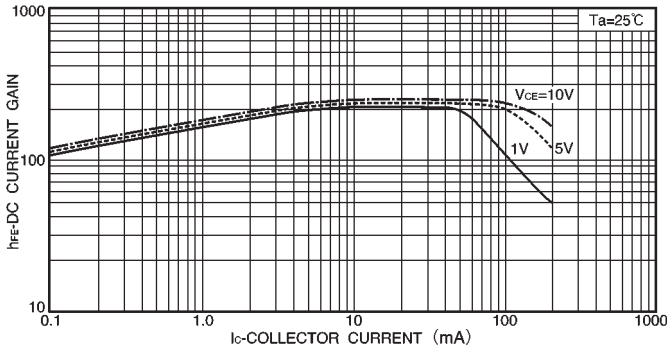

Fig.3 DC current gain vs. collector current (I)

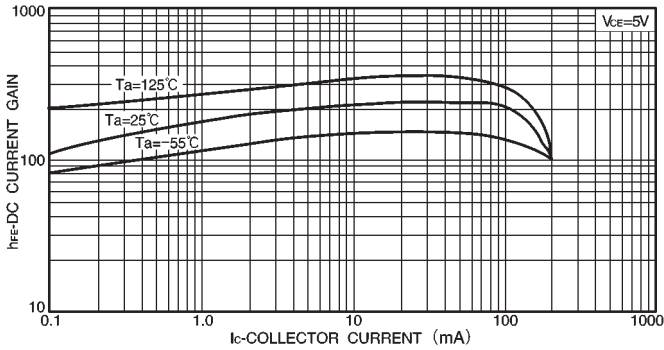

Fig.4 DC current gain vs. collector current (II)

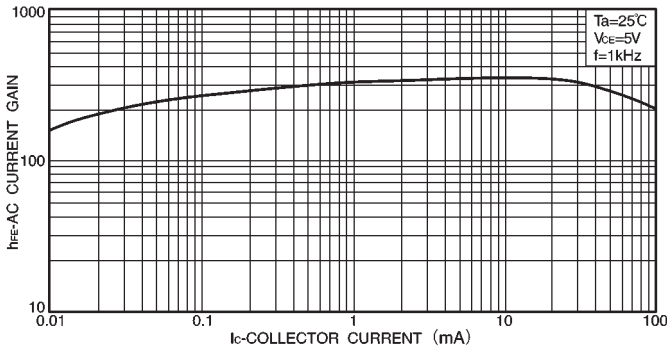

Fig.5 AC current gain vs. collector current

● Electrical characteristic curves

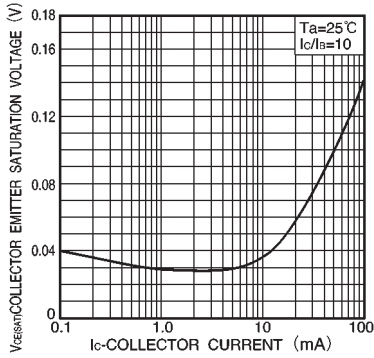

Fig.6 Collector-emitter saturation voltage vs. collector current

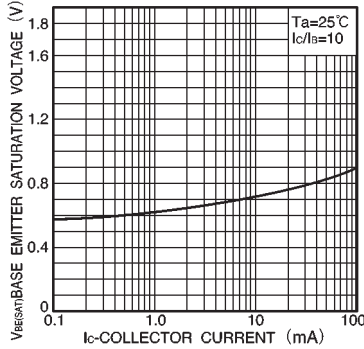

Fig.7 Base-emitter saturation voltage vs. collector current

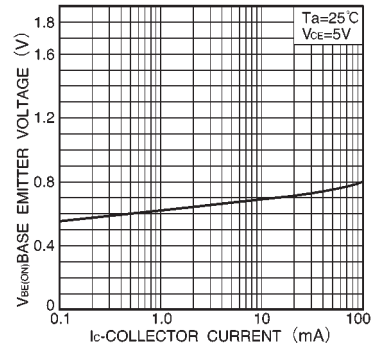

Fig.8 Grounded emitter propagation characteristics

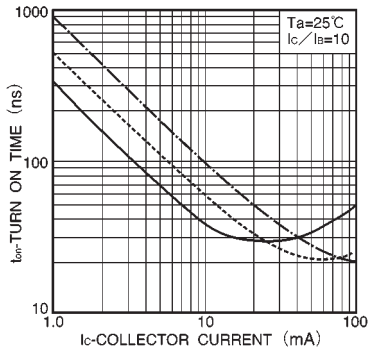

Fig.9 Turn-on time vs. collector current

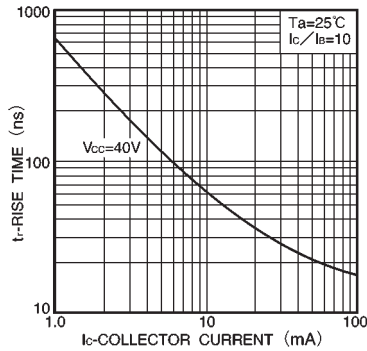

Fig.10 Rise time vs. collector current

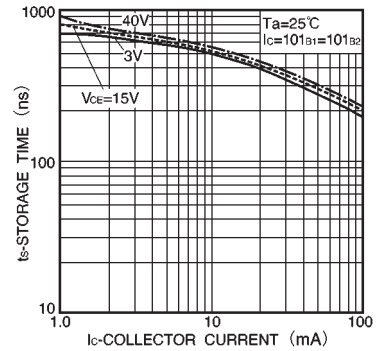

Fig.11 Storage time vs. collector current

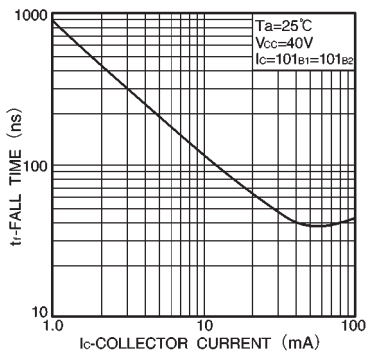

Fig.12 Fall time vs. collector current

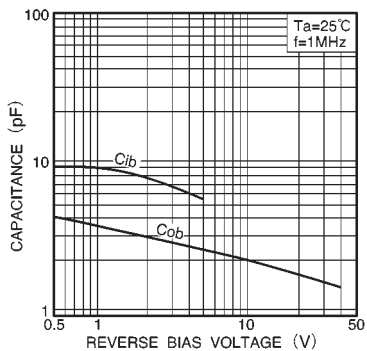

Fig.13 Input/output capacitance vs. voltage

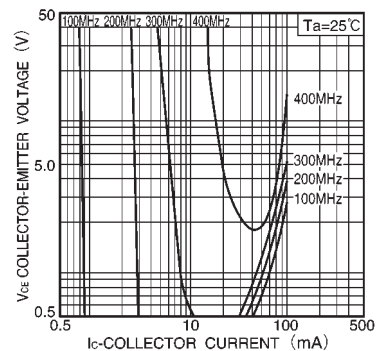

Fig.14 Gain bandwidth product

●Electrical characteristic curves

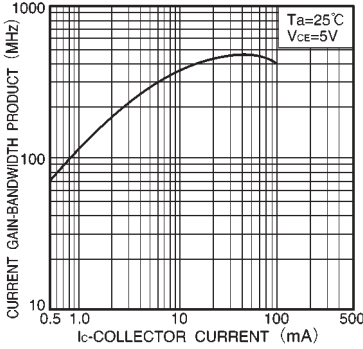

Fig.15 Gain bandwidth product vs. collector current

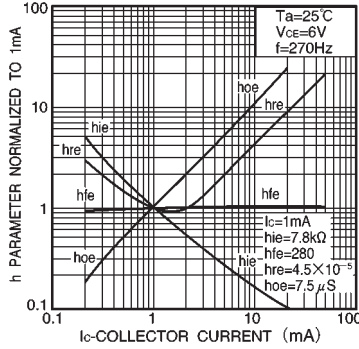

Fig.16 h parameter vs. collector current

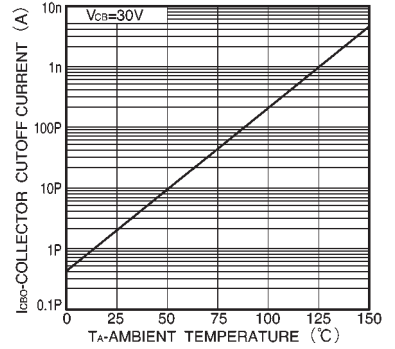

Fig.17 Collector cutoff current

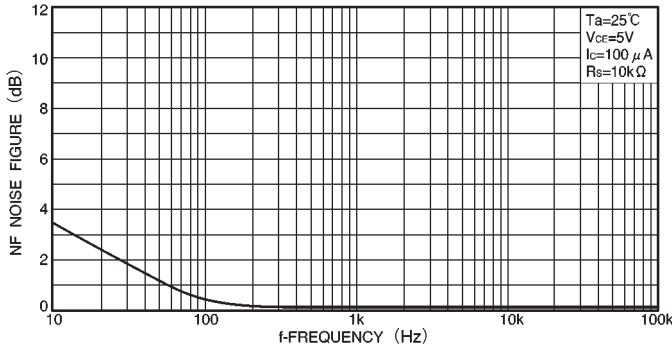

Fig.18 Noise vs. collector current

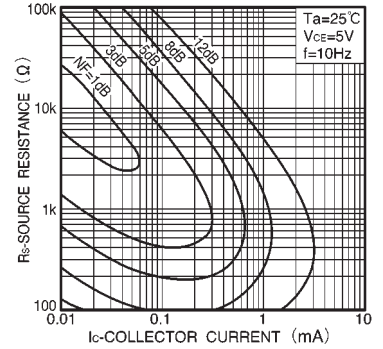

Fig.19 Noise characteristics (I)

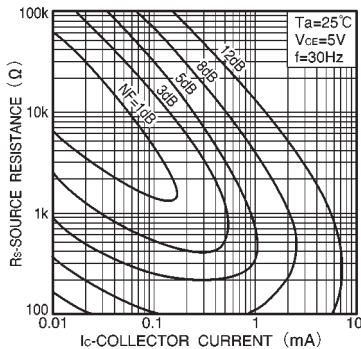

Fig.20 Noise characteristics (II)

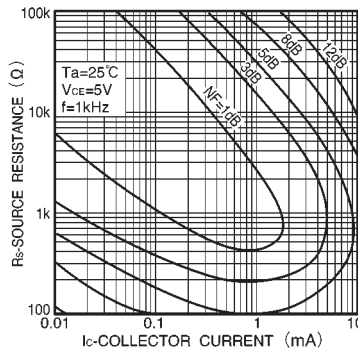

Fig.21 Noise characteristics (III)

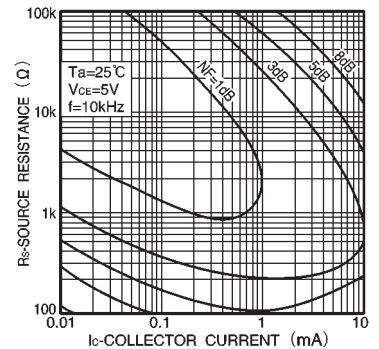

Fig.22 Noise characteristics (IV)