

DATA SHEET

BLV21 VHF power transistor

Product specification
File under Discrete Semiconductors, SC08a

August 1986

VHF power transistor

BLV21

DESCRIPTION

N-P-N silicon planar epitaxial transistor intended for use in class-A, B and C operated h.f. and v.h.f. transmitters with a nominal supply voltage of 28 V. The transistor is resistance stabilized and is guaranteed to withstand severe load mismatch conditions.

It has a 3/8" flange envelope with a ceramic cap. All leads are isolated from the flange.

QUICK REFERENCE DATA

R.F. performance up to $T_h = 25\text{ }^\circ\text{C}$ in an unneutralized common-emitter class-B circuit

MODE OF OPERATION	V_{CE} V	f MHz	P_L W	G_p dB	η %	\bar{z}_i Ω	\bar{Y}_L mS
c.w.	28	175	15	> 10	> 65	$1,4 + j1,85$	$33 - j27,5$

PIN CONFIGURATION

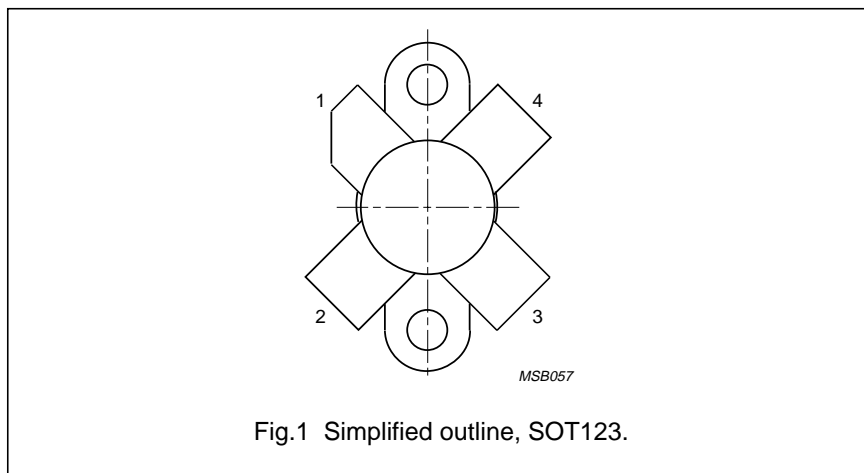

PINNING

PIN	DESCRIPTION
1	collector
2	emitter
3	base
4	emitter

PRODUCT SAFETY This device incorporates beryllium oxide, the dust of which is toxic. The device is entirely safe provided that the BeO disc is not damaged.

VHF power transistor

BLV21

RATINGS

Limiting values in accordance with the Absolute Maximum System (IEC 134)

Collector-emitter voltage ($V_{BE} = 0$)

peak value

V_{CESM} max. 65 V

Collector-emitter voltage (open base)

V_{CEO} max. 36 V

Emitter-base voltage (open collector)

V_{EBO} max. 4 V

Collector current (average)

$I_{C(AV)}$ max. 1,75 A

Collector current (peak value); $f > 1$ MHz

I_{CM} max. 5,0 A

R.F. power dissipation ($f > 1$ MHz); $T_{mb} = 25$ °C

P_{rf} max. 36 W

Storage temperature

T_{stg} -65 to + 150 °C

Operating junction temperature

T_j max. 200 °C

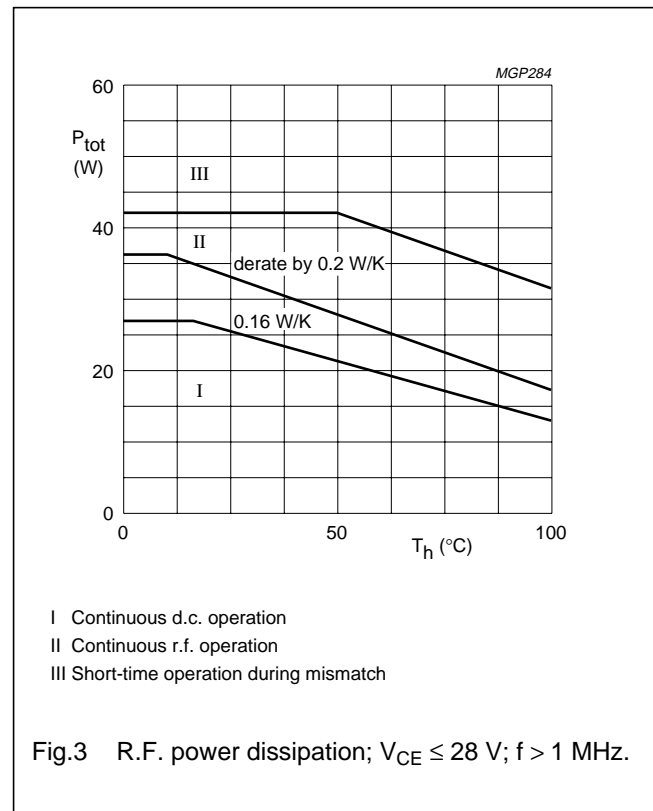
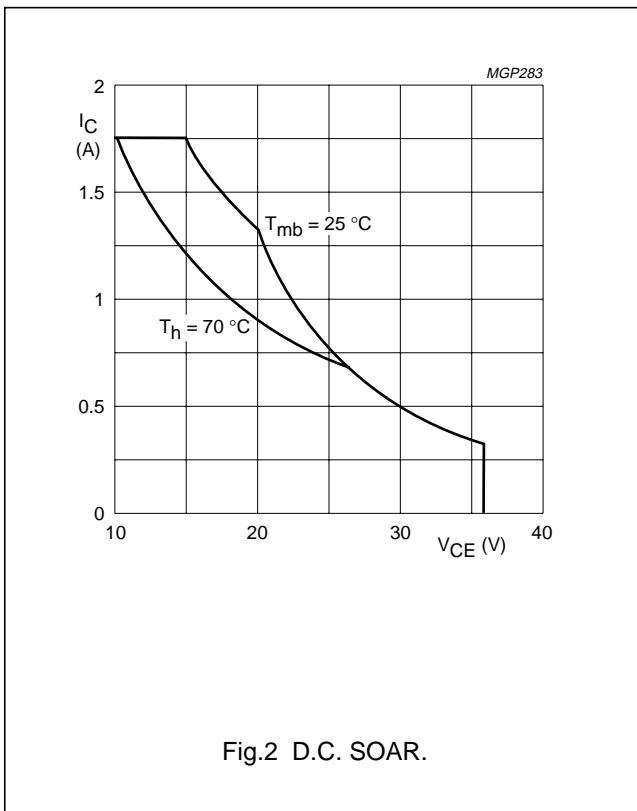

THERMAL RESISTANCE

(dissipation = 15 W; $T_{mb} = 74,5$ °C, i.e. $T_h = 70$ °C)

From junction to mounting base (d.c. dissipation)

$R_{th\ j-mb(dc)}$ = 6,55 K/W

From junction to mounting base (r.f. dissipation)

$R_{th\ j-mb(rf)}$ = 4,95 K/W

From mounting base to heatsink

$R_{th\ mb-h}$ = 0,3 K/W

VHF power transistor

BLV21

CHARACTERISTICS

$T_j = 25\text{ }^\circ\text{C}$

Collector-emitter breakdown voltage

$V_{BE} = 0; I_C = 5\text{ mA}$

$V_{(BR)CES} > 65\text{ V}$

Collector-emitter breakdown voltage

open base; $I_C = 25\text{ mA}$

$V_{(BR)CEO} > 36\text{ V}$

Emitter-base breakdown voltage

open collector; $I_E = 2\text{ mA}$

$V_{(BR)EBO} > 4\text{ V}$

Collector cut-off current

$V_{BE} = 0; V_{CE} = 36\text{ V}$

$I_{CES} < 2\text{ mA}$

Second breakdown energy; $L = 25\text{ mH}; f = 50\text{ Hz}$

open base

$E_{SBO} > 2,5\text{ mJ}$

$R_{BE} = 10\ \Omega$

$E_{SBR} > 2,5\text{ mJ}$

D.C. current gain⁽¹⁾

$I_C = 0,7\text{ A}; V_{CE} = 5\text{ V}$

h_{FE} typ. 50
10 to 100

Collector-emitter saturation voltage⁽¹⁾

$I_C = 2\text{ A}; I_B = 0,4\text{ A}$

V_{CEsat} typ. 0,65 V

Transition frequency at $f = 100\text{ MHz}$ ⁽¹⁾

$-I_E = 0,7\text{ A}; V_{CB} = 28\text{ V}$

f_T typ. 650 MHz

$-I_E = 2\text{ A}; V_{CB} = 28\text{ V}$

f_T typ. 625 MHz

Collector capacitance at $f = 1\text{ MHz}$

$I_E = I_e = 0; V_{CB} = 28\text{ V}$

C_c typ. 18 pF

Feedback capacitance at $f = 1\text{ MHz}$

$I_C = 100\text{ mA}; V_{CE} = 28\text{ V}$

C_{re} typ. 12,8 pF

Collector-flange capacitance

C_{cf} typ. 2 pF

Note

1. Measured under pulse conditions: $t_p \leq 200\ \mu\text{s}; \delta \leq 0,02$.

VHF power transistor

BLV21

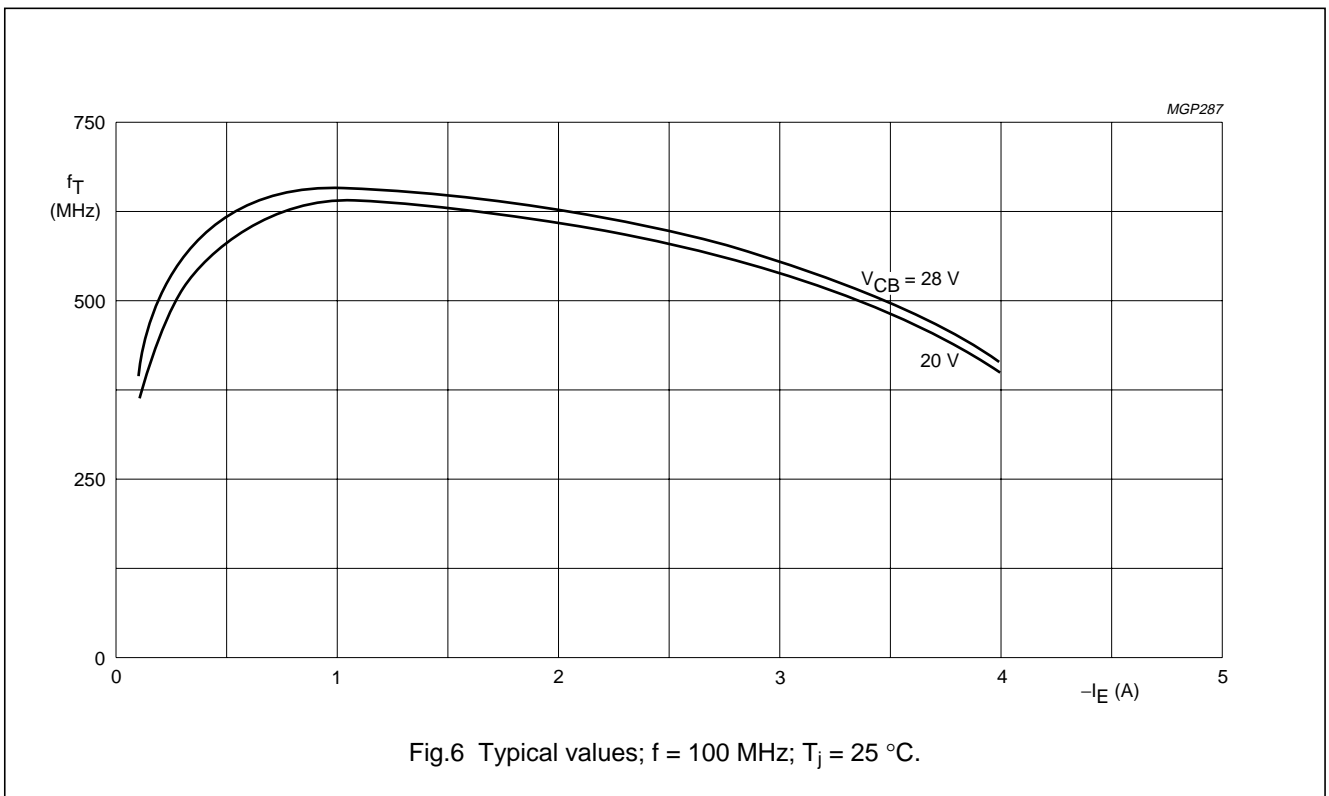
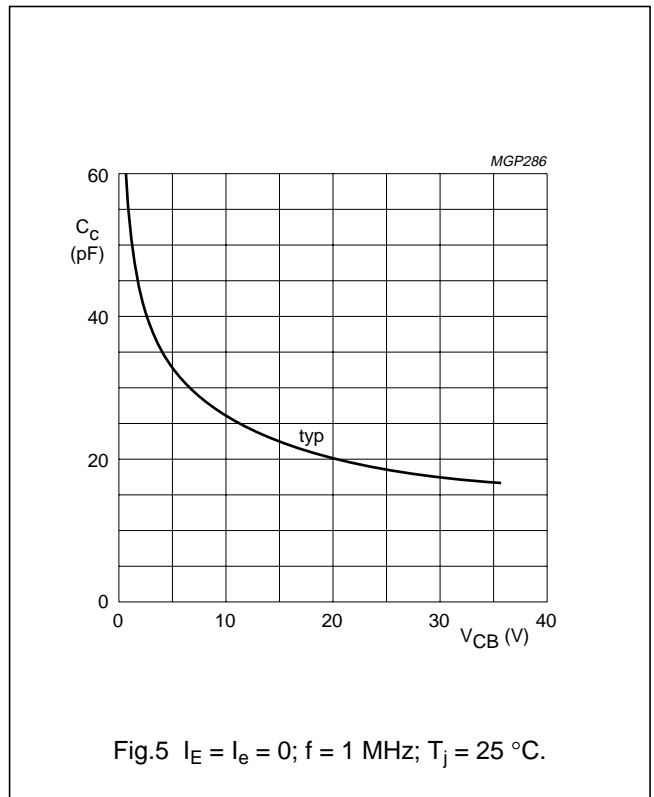
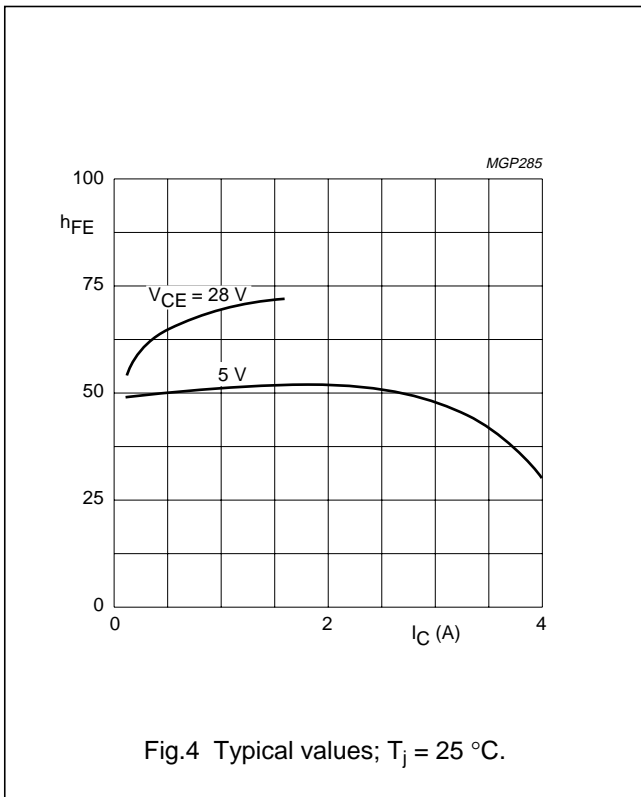

VHF power transistor

BLV21

APPLICATION INFORMATION

R.F. performance in c.w. operation (unneutralized common-emitter class-B circuit) $T_h = 25\text{ }^\circ\text{C}$

f (MHz)	V_{CE} (V)	P_L (W)	P_S (W)	G_P (dB)	I_C (A)	η (%)	\bar{z}_i (Ω)	\bar{Y}_L (mS)
175	28	15	< 1,5	> 10	< 0,83	> 65	$1,4 + j1,85$	$33 - j27,5$

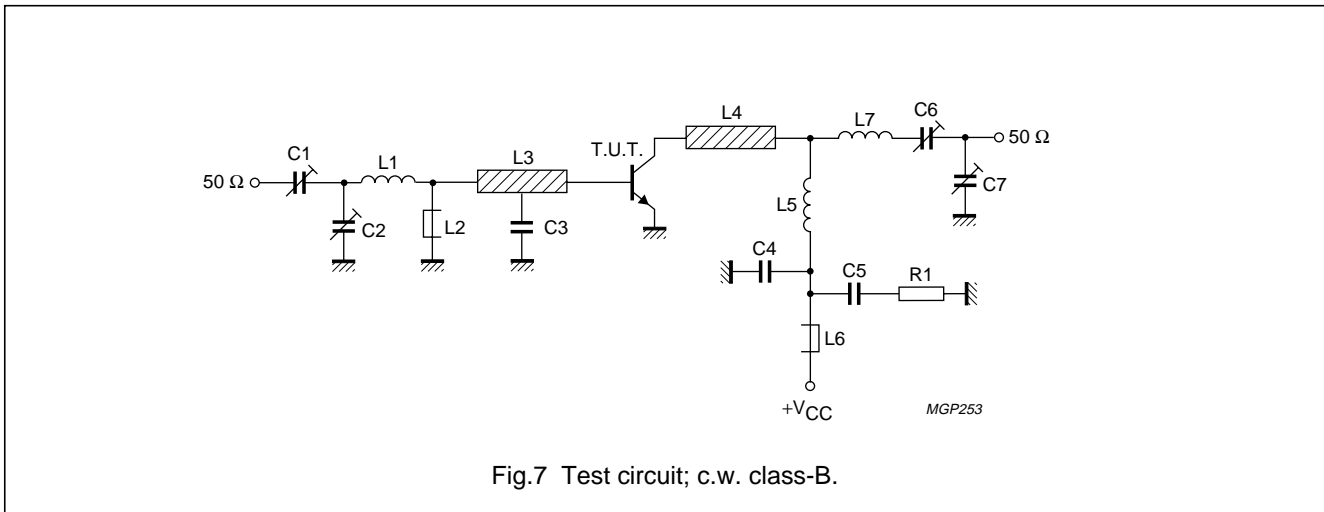

Fig.7 Test circuit; c.w. class-B.

List of components:

- C1 = C7 = 2,5 to 20 pF film dielectric trimmer (cat. no. 2222 809 07004)
 - C2 = C6 = 5 to 60 pF film dielectric trimmer (cat. no. 2222 809 07011)
 - C3 = 27 pF ceramic capacitor (500 V)
 - C4 = 120 pF ceramic capacitor (500 V)
 - C5 = 100 nF polyester capacitor
 - L1 = 1 turn Cu wire (1,6 mm); int. dia. 8,4 mm; leads 2×5 mm
 - L2 = 7 turns closely wound enamelled Cu wire (0,5 mm); int. dia. 3 mm; leads 2×5 mm
 - L3 = L8 = Ferroxcube wide band h.f. choke, grade 3B (cat. no. 4312 020 36640)
 - L4 = L5 = strip (12 mm \times 6 mm); tap for C3 at 5 mm from transistor
 - L6 = 3 turns closely wound enamelled Cu wire (1,0 mm); int. dia. 9,0 mm; leads 2×5 mm
 - L7 = 3 turns closely wound enamelled Cu wire (1,0 mm); int. dia. 8,2 mm; leads 2×5 mm
- L4 and L5 are strips on a double Cu-clad printed-circuit board with epoxy fibre-glass dielectric, thickness 1/16".
- R1 = R2 = 10 Ω carbon resistor

Component layout and printed-circuit board for 175 MHz test circuit see Fig.8.

VHF power transistor

BLV21

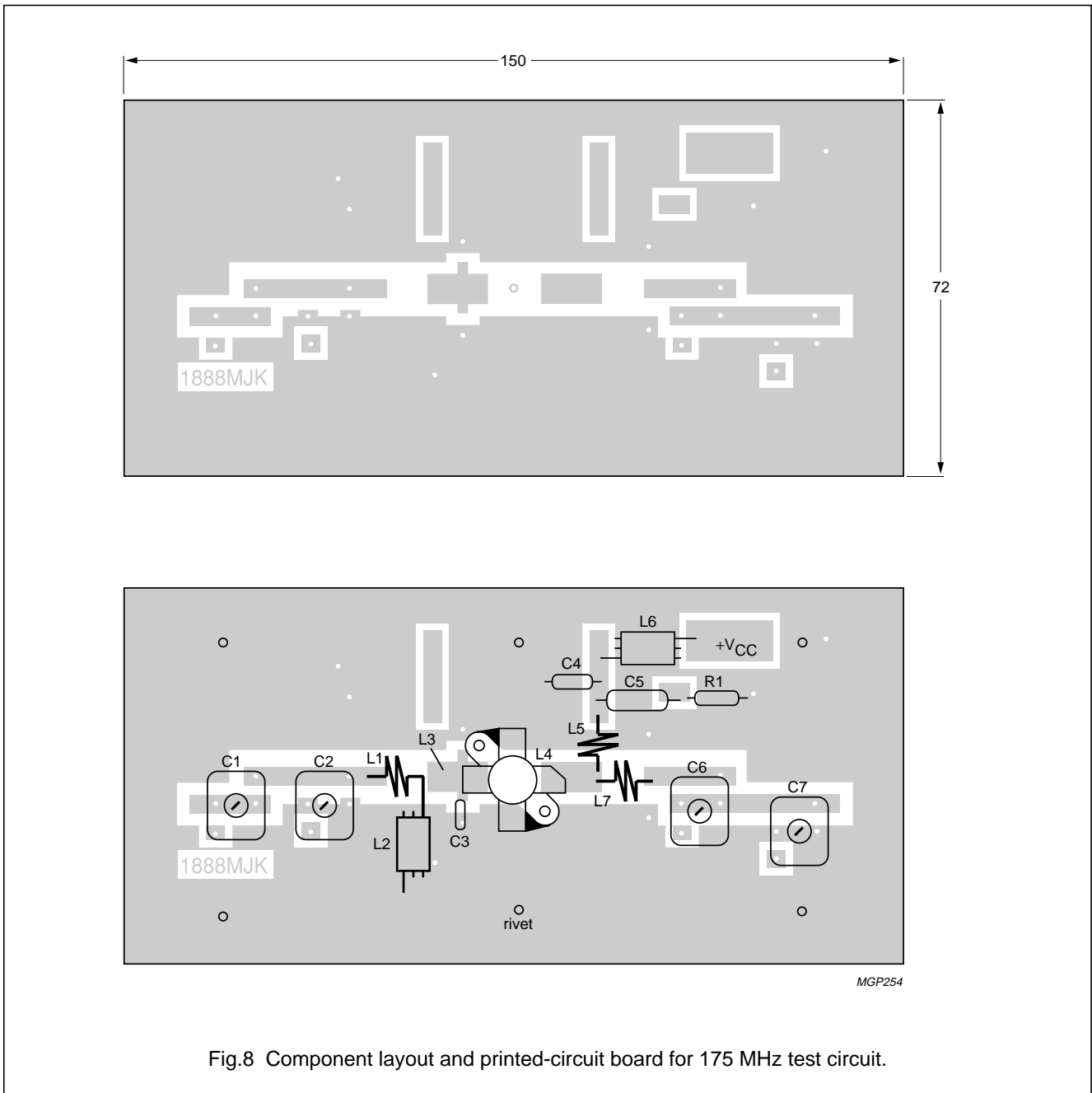

Fig.8 Component layout and printed-circuit board for 175 MHz test circuit.

The circuit and the components are situated on one side of the epoxy fibre-glass board, the other side being fully metallized to serve as earth. Earth connections are made by means of hollow rivets, whilst under the emitter leads Cu straps are used for a direct contact between upper and lower sheets.

VHF power transistor

BLV21

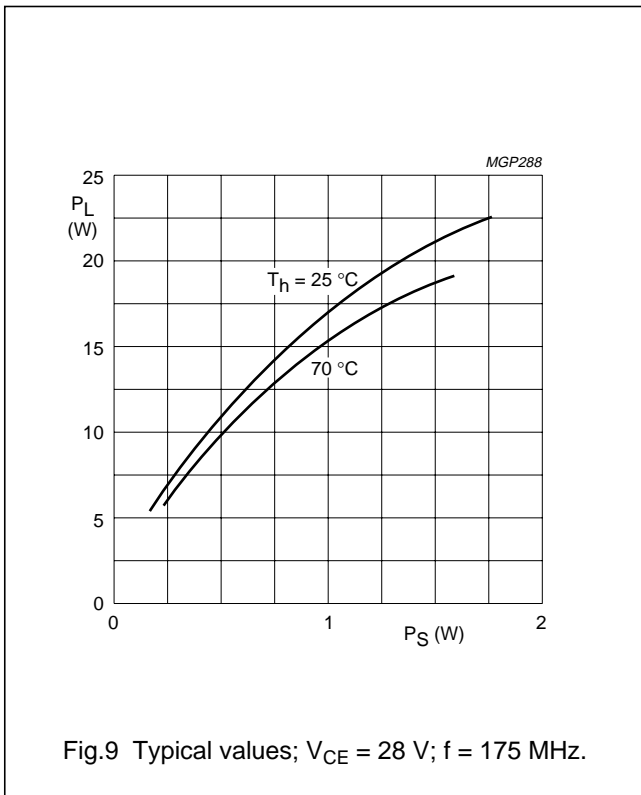

Fig.9 Typical values; $V_{CE} = 28$ V; $f = 175$ MHz.

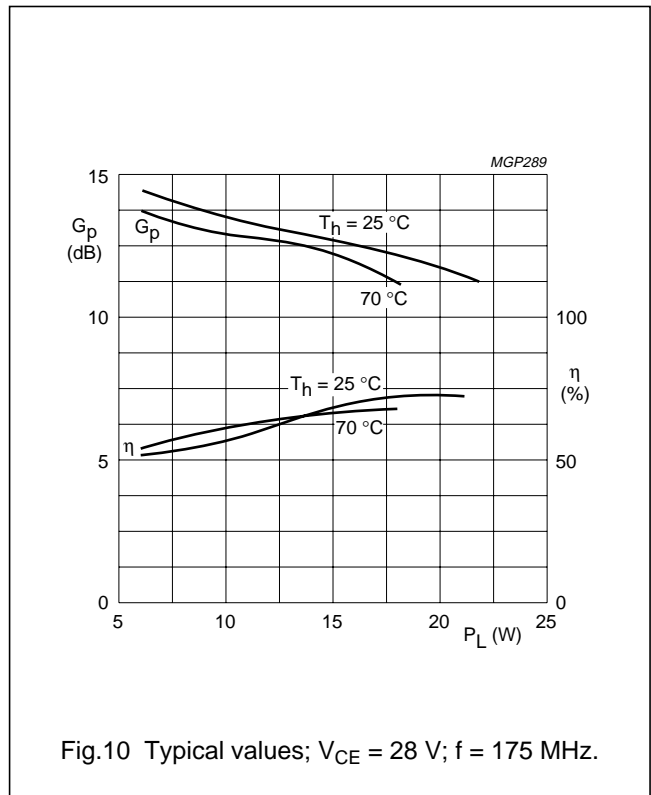
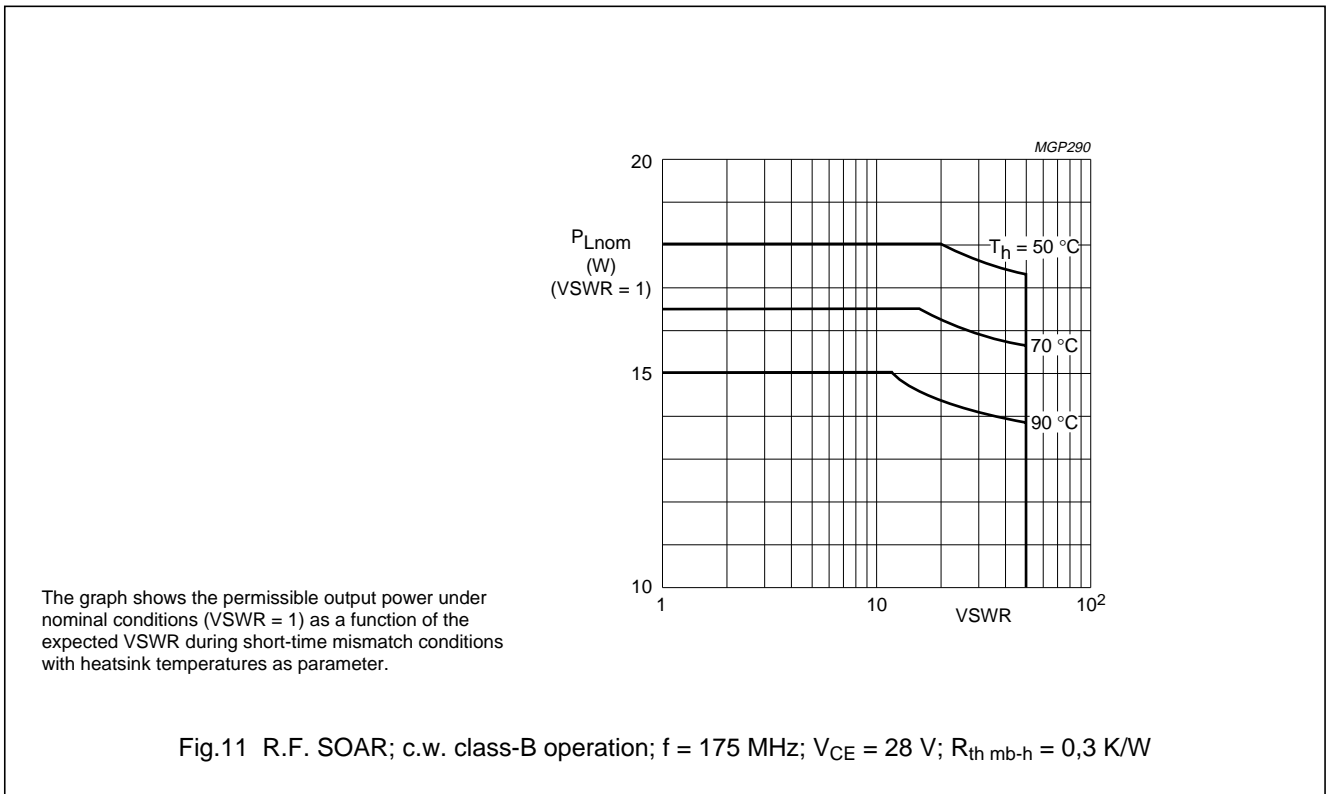

Fig.10 Typical values; $V_{CE} = 28$ V; $f = 175$ MHz.



The graph shows the permissible output power under nominal conditions (VSWR = 1) as a function of the expected VSWR during short-time mismatch conditions with heatsink temperatures as parameter.

Fig.11 R.F. SOAR; c.w. class-B operation; $f = 175$ MHz; $V_{CE} = 28$ V; $R_{th\ mb-h} = 0,3$ K/W

VHF power transistor

BLV21

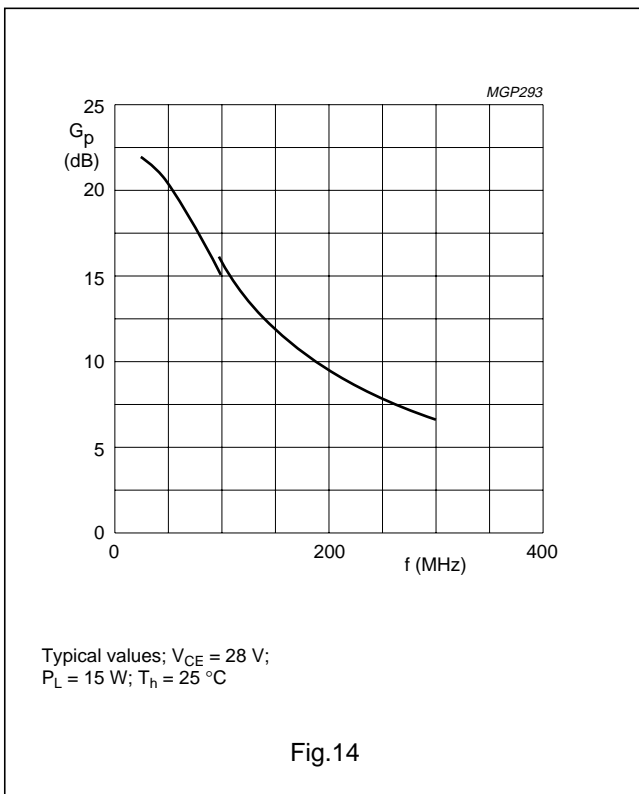
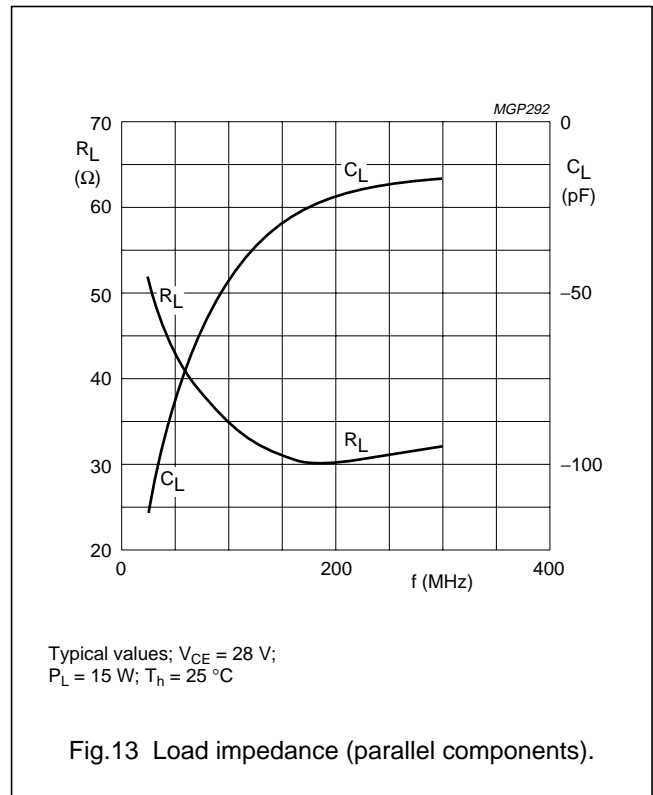
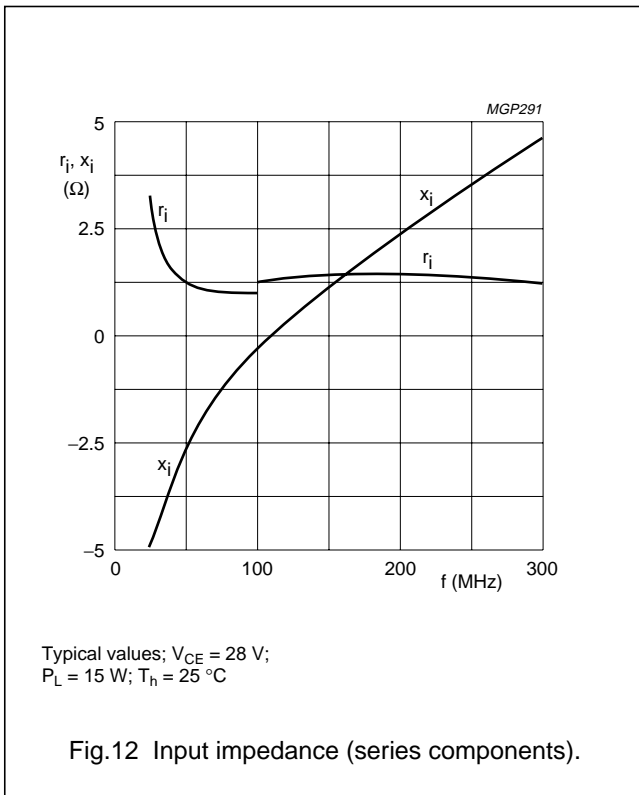

OPERATING NOTE

Below 100 MHz a base-emitter resistor of 10 Ω is recommended to avoid oscillation. This resistor must be effective for r.f. only.

VHF power transistor

BLV21

PACKAGE OUTLINE

Flanged ceramic package; 2 mounting holes; 4 leads

SOT123A



DIMENSIONS (millimetre dimensions are derived from the original inch dimensions)

UNIT	A	b	c	D	D ₁	F	H	L	p	Q	q	U ₁	U ₂	U ₃	w ₁	w ₂	α
mm	7.47 6.37	5.82 5.56	0.18 0.10	9.73 9.47	9.63 9.42	2.72 2.31	20.71 19.93	5.61 5.16	3.33 3.04	4.63 4.11	18.42	25.15 24.38	6.61 6.09	9.78 9.39	0.51	1.02	45°
inches	0.294 0.251	0.229 0.219	0.007 0.004	0.383 0.373	0.397 0.371	0.107 0.091	0.815 0.785	0.221 0.203	0.131 0.120	0.182 0.162	0.725	0.99 0.96	0.26 0.24	0.385 0.370	0.02	0.04	

OUTLINE VERSION	REFERENCES				EUROPEAN PROJECTION	ISSUE DATE
	IEC	JEDEC	EIAJ			
SOT123A						97-06-28

VHF power transistor

BLV21

DEFINITIONS

Data Sheet Status	
Objective specification	This data sheet contains target or goal specifications for product development.
Preliminary specification	This data sheet contains preliminary data; supplementary data may be published later.
Product specification	This data sheet contains final product specifications.
Limiting values	
Limiting values given are in accordance with the Absolute Maximum Rating System (IEC 134). Stress above one or more of the limiting values may cause permanent damage to the device. These are stress ratings only and operation of the device at these or at any other conditions above those given in the Characteristics sections of the specification is not implied. Exposure to limiting values for extended periods may affect device reliability.	
Application information	
Where application information is given, it is advisory and does not form part of the specification.	

LIFE SUPPORT APPLICATIONS

These products are not designed for use in life support appliances, devices, or systems where malfunction of these products can reasonably be expected to result in personal injury. Philips customers using or selling these products for use in such applications do so at their own risk and agree to fully indemnify Philips for any damages resulting from such improper use or sale.