

HIGH VOLTAGE SWITCH

DESCRIPTION

The BSW 67 and BSW 68 are silicon epitaxial planar NPN transistors in Jedec TO-39 metal case. They are intended for high voltage inductive load switching applications.

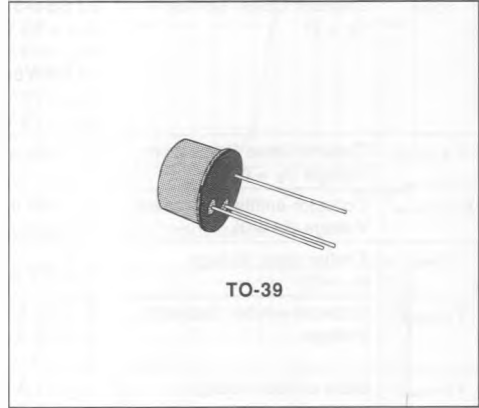

INTERNAL SCHEMATIC DIAGRAM

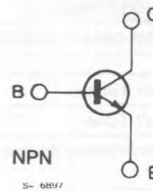

ABSOLUTE MAXIMUM RATINGS

Symbol	Parameter	Value		Unit
		BSW67	BSW68	
V_{CBO}	Collector-base Voltage ($I_E = 0$)	120	150	V
V_{CEO}	Collector-emitter Voltage ($I_B = 0$)	120	150	V
I_C	Collector Current	1.5		A
I_{CM}	Collector Peak Current	2		A
P_{Tot}	Total Power Dissipation at $T_{amb} \leq 45^\circ\text{C}$ $T_{case} \leq 25^\circ\text{C}$ $T_{case} \leq 100^\circ\text{C}$	0.7		W
		5		W
		2.85		W
T_{stg}	Storage Temperature	- 65 to 200		$^\circ\text{C}$
T_j	Junction Temperature	200		$^\circ\text{C}$

THERMAL DATA

$R_{th\ j-case}$	Thermal Resistance Junction-case	Max	35	°C/W
$R_{th\ j-amb}$	Thermal Resistance Junction-ambient	Max	220	°C/W

ELECTRICAL CHARACTERISTICS ($T_{case} = 25\text{ °C}$ unless otherwise specified)

Symbol	Parameter	Test Conditions	Min.	Typ.	Max.	Unit
I_{CBO}	Collector Cutoff Current ($I_E = 0$)	for BSW67 $V_{CB} = 60\text{ V}$ $V_{CB} = 60\text{ V}$ for BSW68 $V_{CB} = 75\text{ V}$ $V_{CB} = 75\text{ V}$ $T_{case} = 150\text{ °C}$ $T_{case} = 150\text{ °C}$			100 50 100 50	nA μA nA μA
$V_{(BR)CBO}$	Collector-base Breakdown Voltage ($I_E = 0$)	$I_C = 100\text{ μA}$	120 150			V V
$V_{CE0(sus)}^*$	Collector-emitter Sustaining Voltage ($I_B = 0$)	$I_C = 100\text{ mA}$	120 150			V V
V_{EBO}^*	Emitter-base Voltage ($I_C = 0$)	$I_E = 100\text{ μA}$	6			V
$V_{CE(sat)}^*$	Collector-emitter Saturation Voltage	$I_C = 0.1\text{ A}$ $I_C = 0.5\text{ A}$ $I_C = 1\text{ A}$			0.15 0.5 1	V V V
$V_{BE(sat)}^*$	Base-emitter Voltage	$I_C = 0.1\text{ A}$ $I_C = 0.5\text{ A}$ $I_C = 1\text{ A}$			0.9 1.1 1.2	V V V
h_{FE}^*	DC Current Gain	$I_C = 0.1\text{ A}$ $I_C = 0.5\text{ A}$ $I_C = 1\text{ A}$	40 30 15			
f_T	Transition Frequency	$I_C = 100\text{ mA}$		80		MHz
C_{CBO}	Collector-base Capacitance	$I_E = 0$ $f = 1\text{ MHz}$			35	pF
t_{on}	Turn-on Time	$I_C = 0.5\text{ A}$ $V_{B1} = - I_{B2} = 0.05\text{ A}$		0.3		μs
t_{off}	Turn-off Time			1		μs

* Pulsed : pulse duration = 300μs, duty cycle = 1.5%.

Safe Operating Areas.

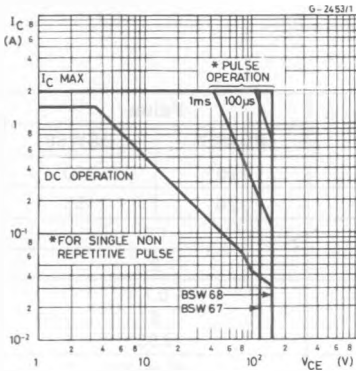

DC Current Gain.

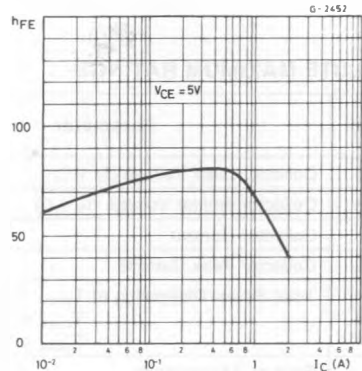

Collector-emitter Saturation Voltage.

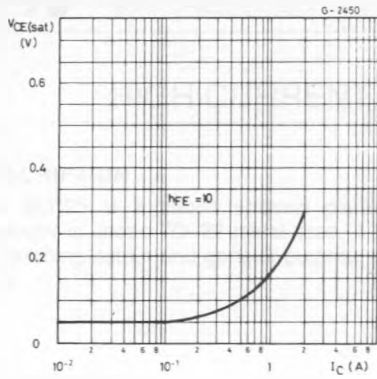

Base-emitter Saturation Voltage.

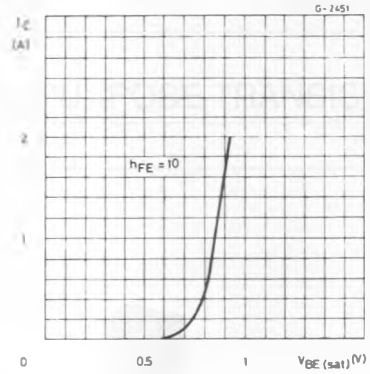

Transition Frequency.

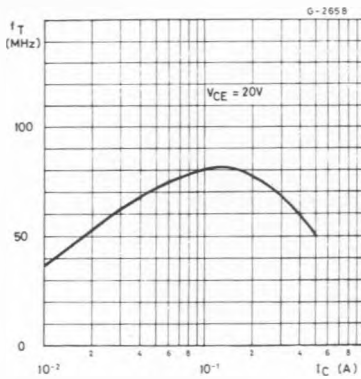

Collector-base Capacitance.

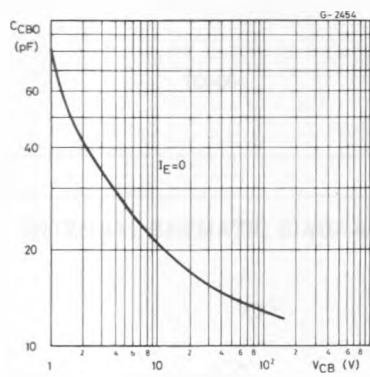

Saturated Switching Characteristics.

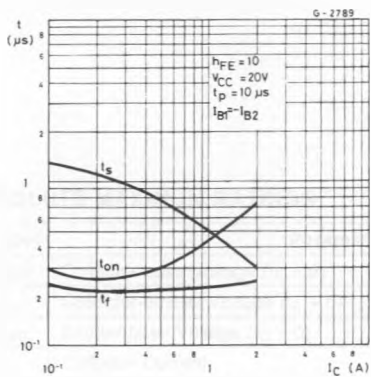

Power Rating Chart.

