

HORIZONTAL TV DEFLECTORS

DESCRIPTION

The BU407 and BU407H are silicon epitaxial planar NPN transistors in Jedec TO-220 plastic package.

They are fast switching, high voltage devices for use in horizontal deflection output stages of medium and small screens MTV receivers with 110° CRT as monochrome computer terminals.

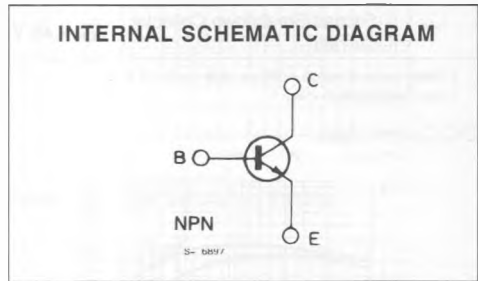
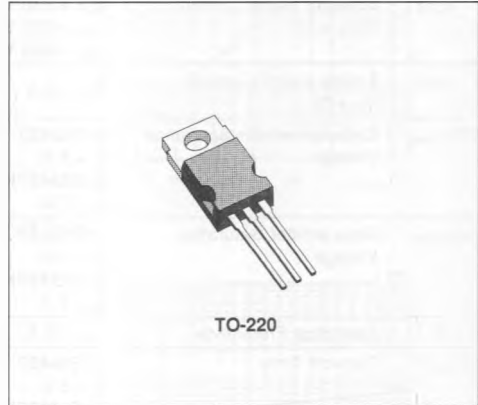

ABSOLUTE MAXIMUM RATINGS

Symbol	Parameter	Value	Unit
V_{CBO}	Collector-base Voltage ($I_E = 0$)	330	V
V_{CEV}	Collector-emitter Voltage ($V_{BE} = -1.5$ V)	330	V
V_{CEO}	Collector-emitter Voltage ($I_B = 0$)	150	V
V_{EBO}	Emitter-base Voltage ($I_C = 0$)	6	V
I_C	Collector Current	7	A
I_{CM}	Collector Peak Current (repetitive)	10	A
I_{CM}	Collector Peak Current ($t = 10$ ms)	15	A
I_B	Base Current	4	A
P_{TOT}	Total Power Dissipation at $T_{case} \leq 25$ °C	60	W
T_{stg}	Storage Temperature	- 65 to 150	°C
T_j	Junction Temperature	150	°C

THERMAL DATA

$R_{thj-case}$	Thermal Resistance Junction-case	Max	2.08	°C/W
$R_{thj-amb}$	Thermal Resistance Junction-ambient	Max	70	°C/W

ELECTRICAL CHARACTERISTICS ($T_{case} = 25\text{ °C}$ unless otherwise specified)

Symbol	Parameter	Test Conditions	Min.	Typ.	Max.	Unit
I_{CES}	Collector Cutoff Current ($V_{BE} = 0$)	$V_{CE} = 330\text{ V}$ $V_{CE} = 200\text{ V}$ $V_{CE} = 200\text{ V}$ $T_{case} = 150\text{ °C}$			5 100 1	mA μA mA
I_{EBO}	Emitter Cutoff Current ($I_C = 0$)	$V_{EB} = 6\text{ V}$			1	mA
$V_{CE(sat)}^*$	Collector-emitter Saturation Voltage	for BU407 $I_C = 5\text{ A}$ $I_B = 0.5\text{ A}$ for BU407H $I_C = 5\text{ A}$ $I_B = 0.8\text{ A}$			1	V
$V_{BE(sat)}^*$	Base-emitter Saturation Voltage	for BU407 $I_C = 5\text{ A}$ $I_B = 0.5\text{ A}$ for BU407H $I_C = 5\text{ A}$ $I_B = 0.8\text{ A}$			1.2 1.2	V V
f_T	Transition Frequency	$I_C = 0.5\text{ A}$ $V_{CE} = 10\text{ V}$	10			MHz
t_{off}^{**}	Turn-off Time	for BU407 $I_C = 5\text{ A}$ $I_{Bend} = 0.5\text{ A}$ for BU407H $I_C = 5\text{ A}$ $I_{Bend} = 0.8\text{ A}$			0.75 0.4	μs μs
$I_{s/b}$	Second Breakdown Collector Current	$V_{CE} = 40\text{ V}$ $t = 10\text{ ms}$		4		A

* Pulsed : pulse duration = 300 μs, duty cycle = 1.5 %.

** See Test Circuit.

DC Current Gain.

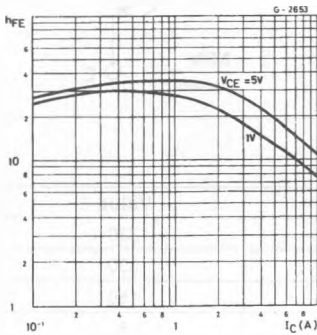

Collector-emitter Saturation Voltage.

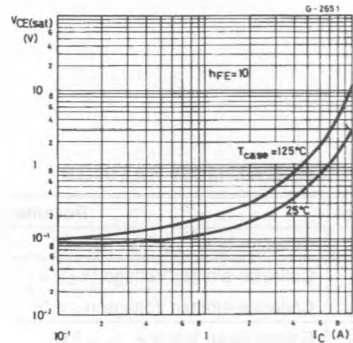

Base-emitter Saturation Voltage.

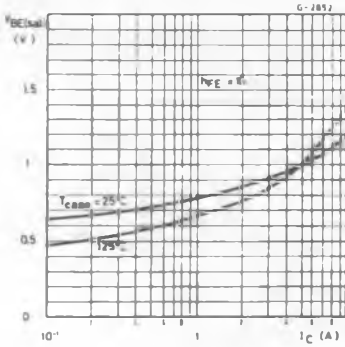

Collector Cutoff Current.

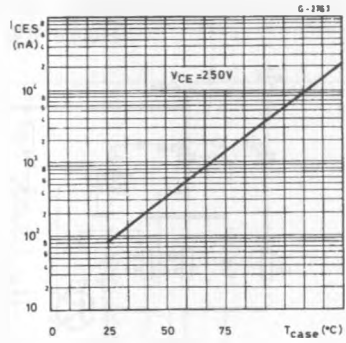

Storage Time.

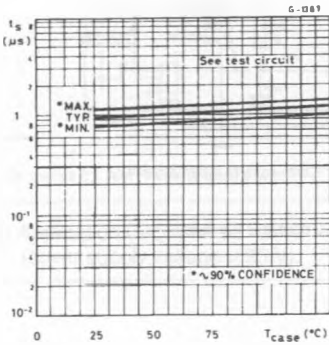

Fall Time.

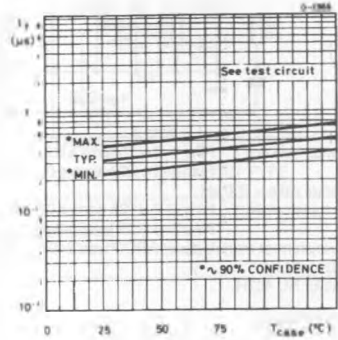

Turn-off Time.

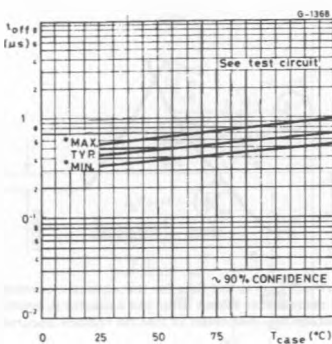

Collector-emitter Saturation Voltage.

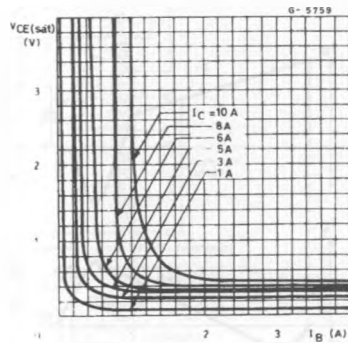

SWITCHING TIMES

TEST CIRCUIT (fall, storage and turn-off time)

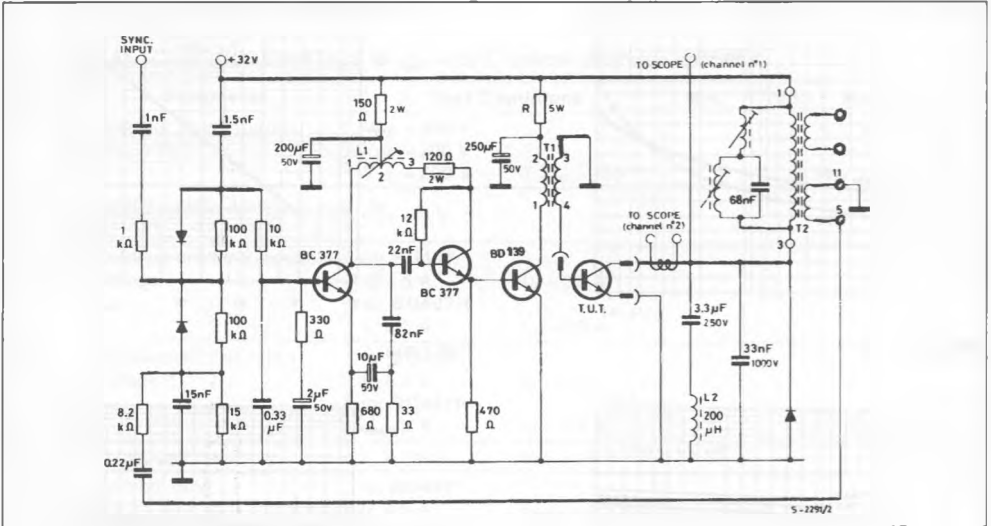

- L1 Horizontal hold coil : Pins 1-2 = 75 turns ϕ 0.2 mm ; R = 1.5 Ω ; L min = 0.62mH
Pins 2-3 = 293 turns ϕ 0.2 mm ; R = 4.8 Ω ; L max = 4.1 mH Core = siferrit B 62120 25x4x2
- L2 Horizontal yoke = 200 μ H
- T1 Driver transformer : Pins 1-2 = 125 turns ϕ 0.2 mm ;
Pins 3-4 = 25 turns ϕ 0.4 mm ; Gap = 0.12 mm ; Core = 3 E 3 double E 19x15x5
- T2 EHT transformer manufacturer ARCO type 249.065/035
R = 330 Ω for BU407
R = 220 Ω for BU 407H.

WAVEFORMS

Fall and Storage Time.

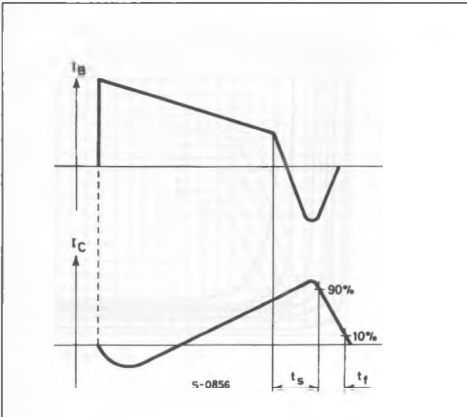

Turn-off Time.

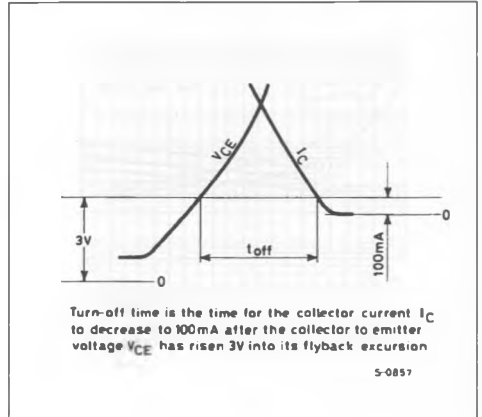

APPLICATION INFORMATION

Two examples are given of the BU407 in conventional MTV horizontal deflection circuits

BU407 : Application Circuit for 12" to 17" - 110° - 20 mm neck picture tubes
(driver supply voltage = 10.8 V).

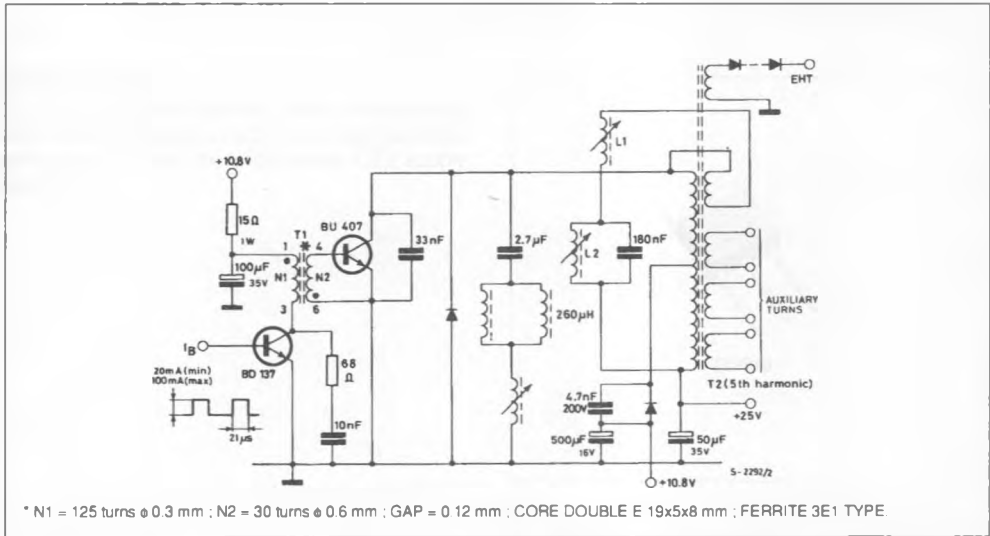

BU407 : Application Circuit for 12" to 17" - 110° - 20 mm neck picture tubes
(driver supply voltage = 25 V).

