

NPN POWER DARLINGTON

- AUTOMOTIVE MARKET
- HIGH PERFORMANCE
- IGNITION DARLINGTON
- HIGH RUGGEDNESS

ELECTRONIC

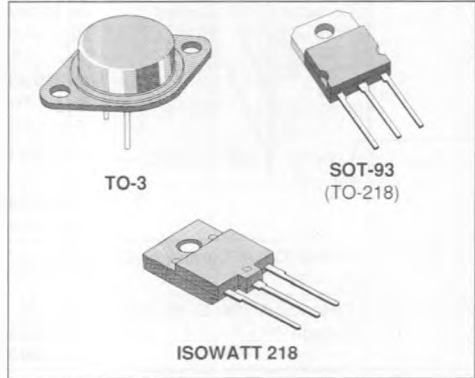

DESCRIPTION

These devices are multi-epitaxial biplanar NPN transistors in monolithic darlington configuration mounted in TO-3, SOT-93 and ISOWATT218 packages. They are specially intended for automotive ignition applications and inverters circuits for motor controls. Controlled performances in the linear region make them particularly suitable for car ignitions where current limiting is achieved desaturating the darlington.

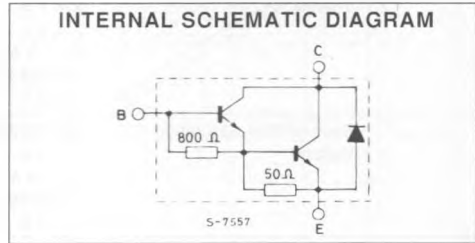

ABSOLUTE MAXIMUM RATINGS

Symbol	Parameter	Value			Unit
		TO-3 SOT-93 ISOWATT218	BU931R BU931RP BU931RPFI	BU932R BU932RP BU932RPFI	
V_{CES}	Collector-emitter Voltage ($V_{BE} = 0$)	450	500		V
V_{CEO}	Collector-emitter Voltage ($I_{BE} = 0$)	400	450		V
V_{EBO}	Emitter-base Voltage ($I_C = 0$)		5		V
I_C	Collector Current		15		A
I_{CM}	Collector Peak Current ($t_p \leq 10$ ms)		30		A
I_B	Base Current		1		A
I_{BM}	Base Peak Current ($t_p \leq 10$ ms)		5		A
		TO-3	SOT-93	ISOWATT218	
P_{tot}	Total Dissipation at $T_C \leq 25^\circ\text{C}$	175	125	60	W
T_{stg}	Storage Temperature	-40 to 200	-40 to 150	-40 to 150	$^\circ\text{C}$
T_J	Max. Operating Junction Temperature	200	150	150	$^\circ\text{C}$

THERMAL DATA

			TO-3	SOT-93	ISOWATT218	
$R_{th(j-case)}$	Thermal Resistance Junction-case	Max	1	1	2.08*	°C/W

ELECTRICAL CHARACTERISTICS ($T_{case} = 25\text{ °C}$ unless otherwise specified)

Symbol	Parameter	Test Conditions	Min.	Typ.	Max.	Unit
I_{CES}	Collector Cutoff Current ($V_{BE} = 0$)	for BU931R/BU931RP/BU931RPFI $V_{CE} = 450\text{ V}$			1	mA
		$V_{CE} = 450\text{ V}$ $T_c = 125\text{ °C}$ for BU932R/BU932RP/BU932RPFI $V_{CE} = 500\text{ V}$			5	mA
I_{CEO}	Collector Cutoff Current ($I_B = 0$)	for BU931R/BU931RP/BU931RPFI $V_{CE} = 400\text{ V}$			1	mA
		for BU932R/BU932RP/BU932RPFI $V_{CE} = 450\text{ V}$			1	mA
I_{EBO}	Emitter Cutoff Current ($I_C = 0$)	$V_{EB} = 5\text{ V}$			50	mA
$V_{CEO(isus)}^*$	Collector-emitter Sustaining Voltage	$I_C = 100\text{ mA}$	400			V
		for BU931R/BU931RP/BU931RPFI for BU932R/BU932RP/BU932RPFI	450			V
$V_{CE(sat)}^*$	Collector-emitter Saturation Voltage	for BU931R/BU931RP/BU931RPFI $I_C = 7\text{ A}$ $I_B = 70\text{ mA}$		1.05	1.6	V
		$I_C = 8\text{ A}$ $I_B = 100\text{ mA}$		1.09	1.8	V
		$I_C = 10\text{ A}$ $I_B = 250\text{ mA}$		1.13	1.8	V
		for BU932R/BU932RP/BU932RPFI $I_C = 8\text{ A}$ $I_B = 150\text{ mA}$		1.09	1.8	V
$V_{BE(sat)}^*$	Base-emitter Saturation Voltage	for BU932R5BU932RP/BU932RPFI $I_C = 8\text{ A}$ $I_B = 100\text{ mA}$		1.75	2.2	V
		$I_C = 10\text{ A}$ $I_B = 250\text{ mA}$		1.92	2.5	V
		for BU932R/BU932RP/BU932RPFI $I_C = 8\text{ A}$ $I_B = 150\text{ mA}$		1.77	2.2	V
h_{FE}^*	DC Current Gain	$I_C = 5\text{ A}$ $V_{CE} = 10\text{ V}$	300			
V_F^*	Diode Forward Voltage	$I_F = 10\text{ A}$		1.43	2.8	V
	USE TEST (see fig. 2)	$V_{CC} = 24\text{ V}$ $V_{clamp} = 400\text{ V}$ $L = 7\text{ mH}$	8			A

INDUCTIVE LOAD

Symbol	Parameter	Test Conditions	Min.	Typ.	Max.	Unit
t_s	(see fig. 3) Storage Time	$V_{CC} = 12\text{ V}$ $V_{clamp} = 300\text{ V}$ $L = 7\text{ mH}$				
		$I_C = 7\text{ A}$ $I_B = 70\text{ mA}$		15		μs
t_f	Fall Time	$V_{BE} = 0$ $R_{BE} = 47\text{ }\Omega$		0.5		μs

* Pulsed : pulse duration = 300 μs , duty cycle = 1.5 %.

Safe Operating Areas.

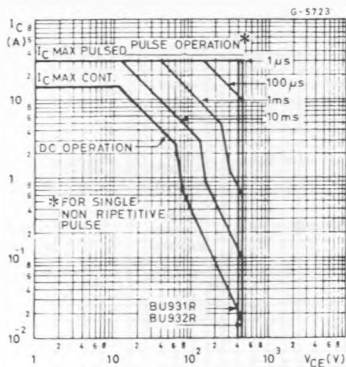

Safe Operating Areas.

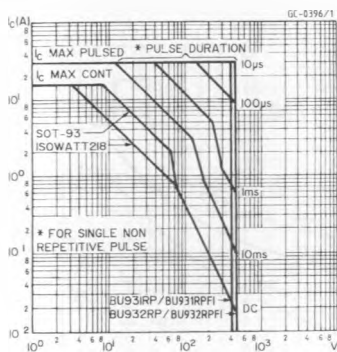

DC Current Gain.

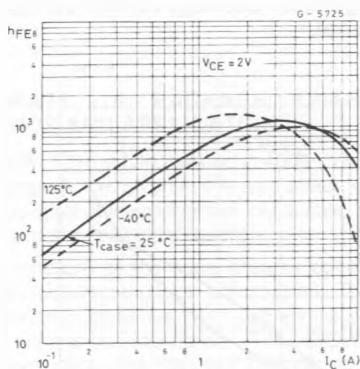

DC Current Gain.

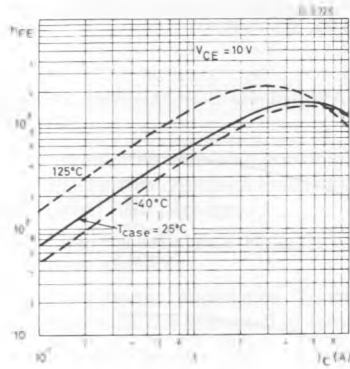

Collector-emitter Saturation Voltage.

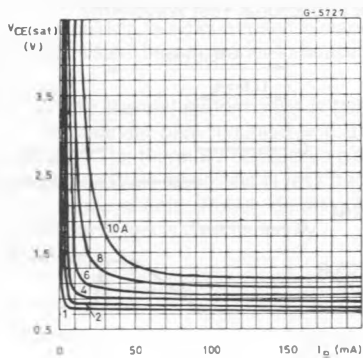

Collector-emitter Saturation Voltage.

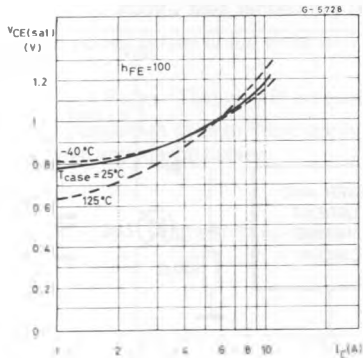

Base-emitter Saturation Voltage.

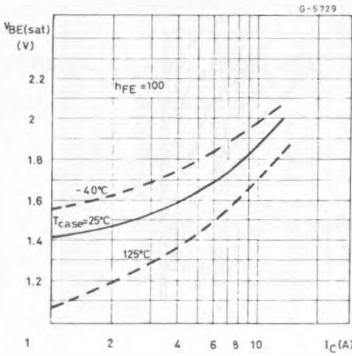

Clamped Reverse Bias Safe Operating Areas (see fig. 4).

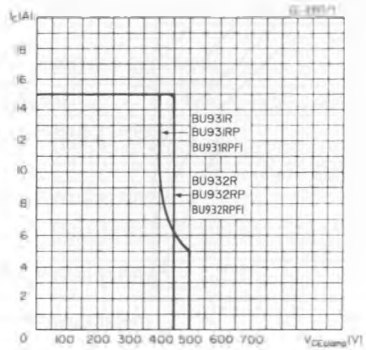

Saturated Switching Characteristics (inductive load) (see fig. 3).

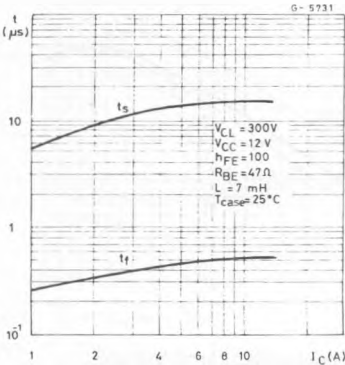

Switching Times Percentage Variation vs. T_{case} Inductive Load.

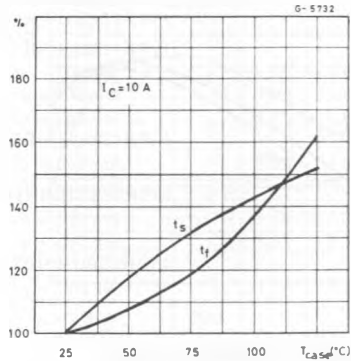

Figure 1: Functional Test Circuit.

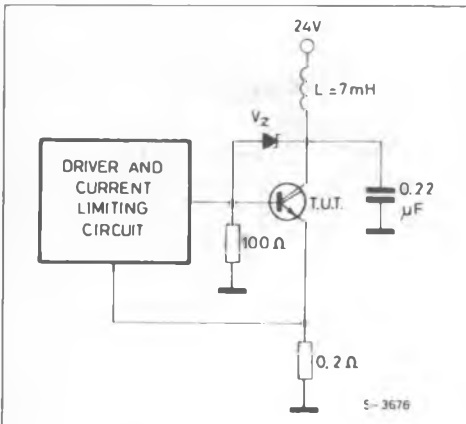

Figure 2 : Functional Test Waveforms.

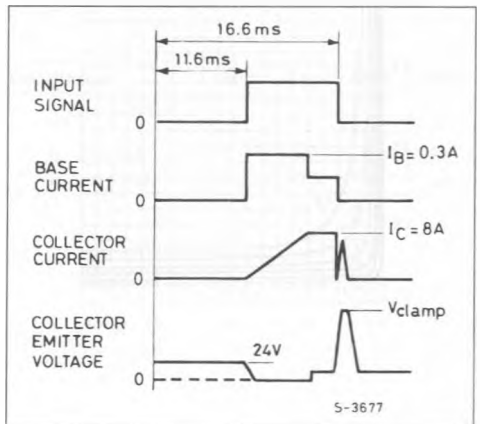

Figure 3 : Switching Times Test Circuit.

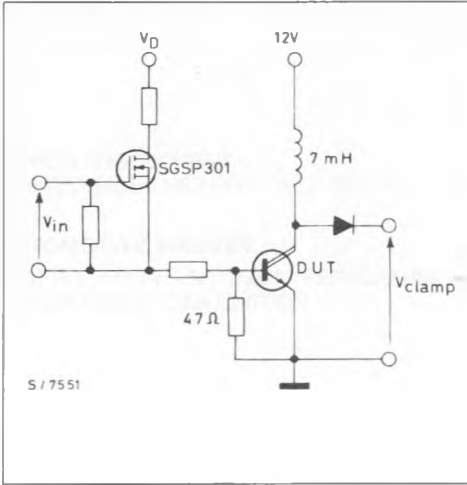
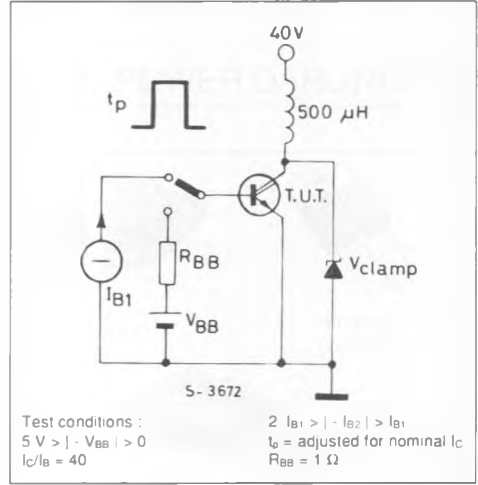

Figure 4 : Clamped E_sb Test Circuit.



ISOWATT 218 PACKAGE CHARACTERISTICS AND APPLICATION

ISOWATT218 is fully isolated to 4000 V dc. Its thermal impedance, given in the data sheet, is optimised to give efficient thermal conduction together with excellent electrical isolation.

The structure of the case ensures optimum distances between the pins and heatsink. These distances are in agreement with VDE and UL creepage and clearance standards. The ISOWATT218 package eliminates the need for external isolation so reducing fixing hardware.

The package is supplied with leads longer than the standard TO-218 to allow easy mounting on pcbs. Accurate moulding techniques used in manufacture assures consistent heat spreader-to-heatsink capacitance.

ISOWATT218 thermal performance is better than that of the standard part, mounted with a 0.1 mm mica washer. The thermally conductive plastic has a higher breakdown rating and is less fragile than mica or plastic sheets. Power derating for ISOWATT218 packages is determined by :

$$P_D = \frac{T_j - T_c}{R_{th}}$$

THERMAL IMPEDANCE OF ISOWATT 218 PACKAGE

Fig. 5 illustrates the elements contributing to the thermal resistance of transistor heatsink assembly, using ISOWATT218 package.

The total thermal resistance $R_{th(tot)}$ is the sum of each of these elements.

The transient thermal impedance, Z_{th} for different pulse durations can be estimated as follows :

1. for a short duration power pulse less than 1 ms ;
 $Z_{th} < R_{thJ-C}$
2. for an intermediate power pulse of 5 ms to 50 ms ;
 $Z_{th} = R_{thJ-C}$
3. for long power pulses of the order of 500 ms or greater :

$$Z_{th} = R_{thJ-C} + R_{thC-HS} + R_{thHS-amb}$$

It is often possible to discern these areas on transient thermal impedance curves.

Figure 5

