

## HIGH VOLTAGE SWITCH

### DESCRIPTION

The BUT11/A and BUT11FI/AFI are silicon multi-epitaxial mesa NPN transistors respectively in Jedec TO-220 plastic package and ISOWATT220 fully isolated package, particularly intended for switching application.

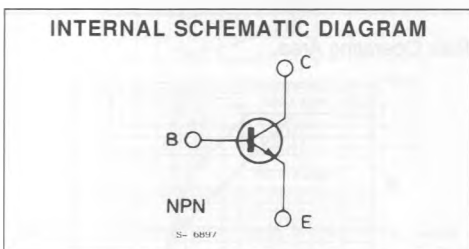
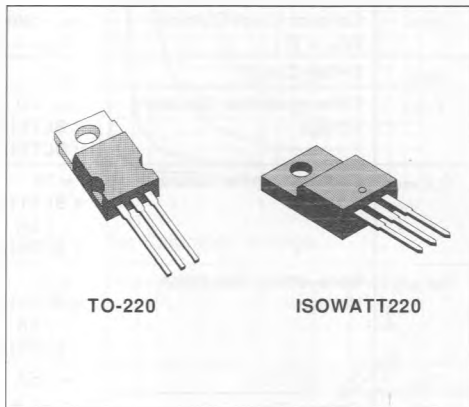

### ABSOLUTE MAXIMUM RATINGS

Symbol	Parameter	Value		Unit
		BUT11/FI	BUT11A/AFI	
$V_{CES}$	Collector-emitter Voltage ( $V_{BE} = 0$ )	850	1000	V
$V_{CEO}$	Collector-emitter Voltage ( $I_B = 0$ )	400	450	V
$V_{EBO}$	Emitter-base Voltage ( $I_C = 0$ )	9		V
$I_C$	Collector Current	5		A
$I_{CM}$	Collector Peak Current	10		A
$I_B$	Base Current	2		A
$I_{BM}$	Base Peak Current	4		A
		TO-220	ISOWATT-220	
$P_{tot}$	Total Power Dissipation at $T_c \leq 25^\circ\text{C}$	83	35	W
$T_{stg}$	Storage Temperature	- 65 to 150		$^\circ\text{C}$
$T_j$	Max. Operating Junction Temperature	150		$^\circ\text{C}$

**THERMAL DATA**

			<b>TO-220</b>	<b>ISOWATT220</b>	
$R_{th\ j-case}$	Thermal Resistance Junction-case	Max	1.5	3.57	°C/W

**ELECTRICAL CHARACTERISTICS** ( $T_{case} = 25^{\circ}C$  unless otherwise specified)

Symbol	Parameter	Test Conditions		Min.	Typ.	Max.	Unit
$I_{CES}$	Collector Cutoff Current ( $V_{BE} = 0$ )	$V_{CE} = \text{rated } V_{CES}$ at $T_{case} = 125^{\circ}C$				1 2	mA mA
$I_{EBO}$	Emitter Cutoff	$I_C = 0$	$V_{EB} = 9V$			10	mA
$V_{CEO}$	Collector-emitter Sustaining Voltage	$I_{B(off)} = 0$ for <b>BUT11/FI</b> for <b>BUT11A/AFI</b>	$I_C = 100mA$	400 450			V V
$V_{CE(sat)}$	Collector-emitter Saturation Voltage	$I_C = 3A$ for <b>BUT11/FI</b> $I_C = 2.5A$ for <b>BUT11A/AFI</b>	$I_B = 0.6A$  $I_B = 0.5A$			1.5 1.5	V V
$V_{BE(sat)}$	Base-emitter Saturation Voltage	$I_C = 3A$ for <b>BUT11/FI</b> $I_C = 2.5A$ for <b>BUT11A/AFI</b>	$I_B = 0.6A$  $I_B = 0.5A$			1.3 1.3	V V
$t_{on}$	Turn on Time	$I_C = 2.5A$	$V_{CC} = 250V$			1	$\mu s$
$t_s$	Storage Time	$I_B = I_{B2} = 0.5A$				4	$\mu s$
$t_f$	Fall Time					0.8	$\mu s$

**Safe Operating Area.**

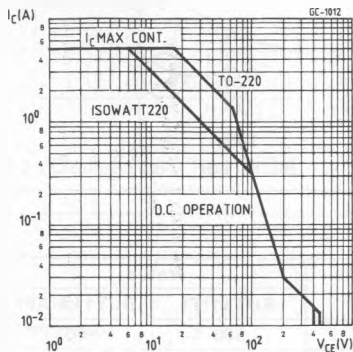

**Reverse Biased Safe Operating Area.**

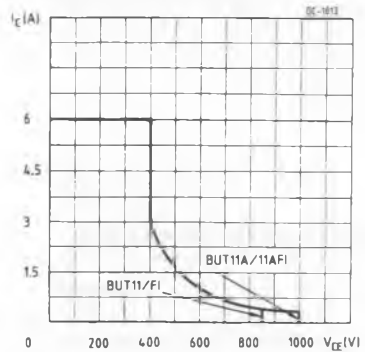

DC Current Gain.

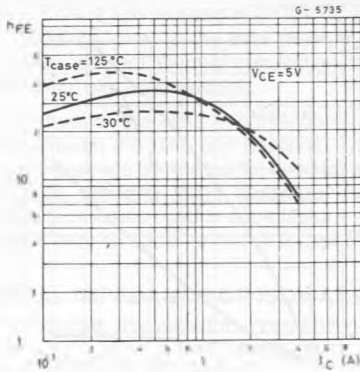

Collector-emitter Saturation Voltage.

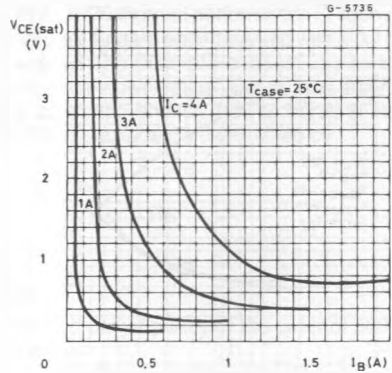

Collector-emitter Saturation Voltage.

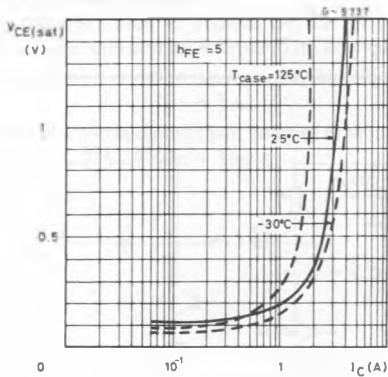

Base-emitter Saturation Voltage.

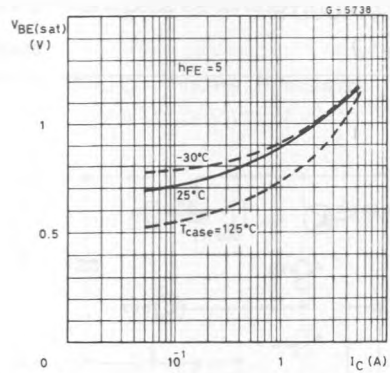

Switching Times Inductive Load (test circuit fig. 2).

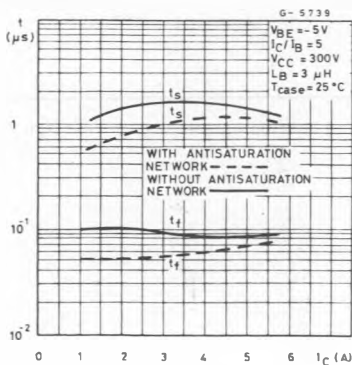

Switching Times Percentage Variation vs. Tcase.

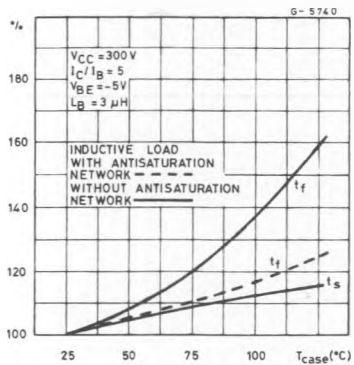

Saturated Switching Characteristics  
(test circuit fig. 1).

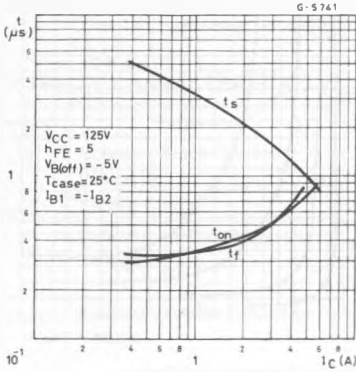

Switching Time Percentage Variation vs.  $T_{case}$   
Resistive Load.

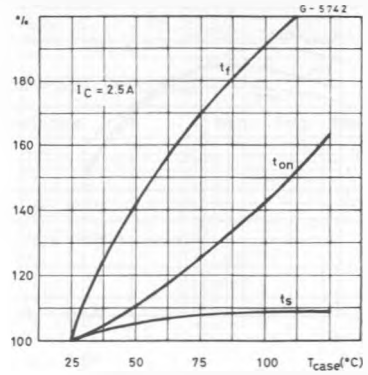

TEST CIRCUITS

Figure 1.

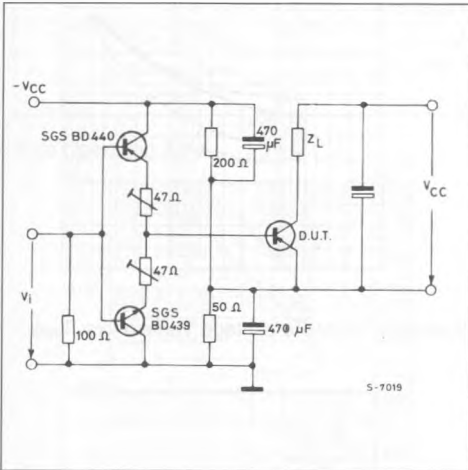
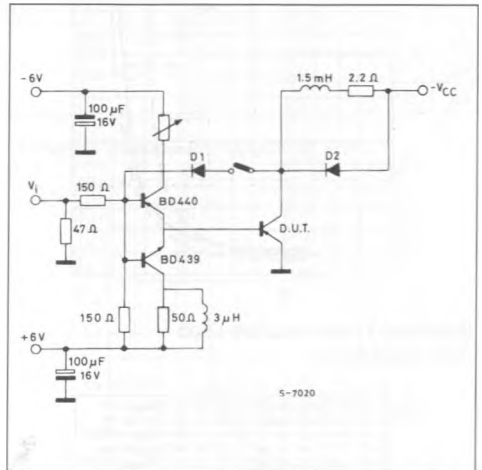

Figure 2.



## ISOWATT220 PACKAGE CHARACTERISTICS AND APPLICATION

ISOWATT220 is fully isolated to 2000V dc. Its thermal impedance, given in the data sheet, is optimized to give efficient thermal conduction together with excellent electrical isolation.

The structure of the case ensures optimum distances between the pins and heatsink. The ISOWATT220 package eliminates the need for external isolation so reducing fixing hardware. Accurate moulding techniques used in manufacture assures consistent heat spreader-to-heatsink capacitance.

ISOWATT220 thermal performance is equivalent to that of the standard part, mounted with a 0.1mm mica washer. The thermally conductive plastic has a higher breakdown rating and is less fragile than mica or plastic sheets. Power derating for ISOWATT220 packages is determined by :

$$P_D = \frac{T_j - T_c}{R_{th}}$$

### THERMAL IMPEDANCE OF ISOWATT220 PACKAGE

Fig. 3 illustrates the elements contributing to the thermal resistance of a transistor heatsink assembly, using ISOWATT220 package.

The total thermal resistance  $R_{th(tot)}$  is the sum of each of these elements.

The transient thermal impedance,  $Z_{th}$  for different pulse durations can be estimated as follows :

1 - for a short duration power pulse less than 1ms :

$$Z_{th} < T_{thJ-C}$$

2 - for an intermediate power pulse of 5ms to 50ms :

$$Z_{th} = T_{thJ-C}$$

3 - for long power pulses of the order of 500ms or greater :

$$Z_{th} = R_{thJ-C} + R_{thC-HS} + R_{thHS-amb}$$

It is often possible to discern these areas on transient thermal impedance curves.

Figure 3.

