

## HIGH VOLTAGE POWER SWITCH

### DESCRIPTION

The BUW32/A, BUW32P/AP and BUW32PFI/APFI are silicon multiepitaxial mesa PNP transistors mounted respectively in TO-3 metal case, TO-218 plastic package and ISOWATT218 fully isolated package. They are intended for high voltage, fast switching and industrial applications.

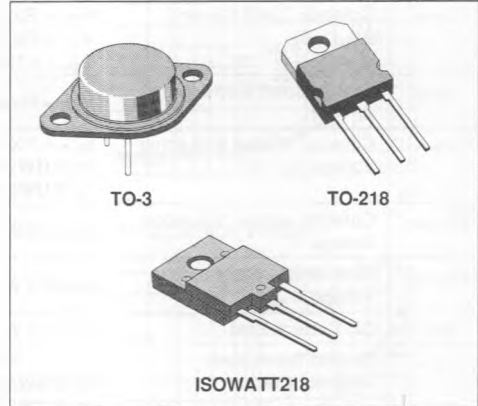

### INTERNAL SCHEMATIC DIAGRAM

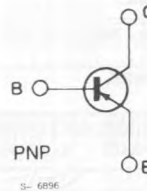

### ABSOLUTE MAXIMUM RATINGS

Symbol	Parameter	BUW			Unit
		32/P/PFI	32A/AP/APFI		
$V_{CES}$	Collector-emitter Voltage ( $V_{BE} = 0$ )	- 400	- 450		V
$V_{CEO}$	Collector-emitter Voltage ( $I_B = 0$ )	- 350	- 400		V
$V_{EBO}$	Emitter-base Voltage ( $I_C = 0$ )	- 5	- 7		V
$I_C$	Collector Current	- 10			A
$I_B$	Base Current	- 5			A
		TO-3	TO-218	ISOWATT218	
$P_{tot}$	Total Power Dissipation at $T_c < 25^\circ\text{C}$	125	105	55	W
$T_{stg}$	Storage Temperature	- 65 to 175	- 65 to 150	- 65 to 150	$^\circ\text{C}$
$T_j$	Max. Operating Junction Temperature	175	150	150	$^\circ\text{C}$

**THERMAL DATA**

			<b>TO-3</b>	<b>TO-218</b>	<b>ISOWATT218</b>	
$R_{th\ j-case}$	Thermal Resistance Junction-case	max	1.19	1.19	2.27	°C/W

**ELECTRICAL CHARACTERISTICS** ( $T_{case} = 25\text{ °C}$  unless otherwise specified)

Symbol	Parameter	Test Conditions	Min.	Typ.	Max.	Unit
$I_{CES}$	Collector Cutoff Current ( $V_{BE} = 0$ )	$V_{CE} = \text{Rated } V_{CES}$ $V_{CE} = \text{Rated } V_{CES}$ $T_{case} = 125\text{ °C}$			- 1	mA
$I_{EBO}$	Emitter Cutoff Current ( $I_C = 0$ )	$V_{EB} = \text{Rated } V_{EBO}$			- 5	mA
$V_{CE0(sus)}^*$	Collector-emitter Sustaining Voltage ( $I_B = 0$ )	$I_C = -100\text{ mA}$ for <b>BUW32/P/PFI</b> for <b>BUW32A/AP/APFI</b>	- 350			V
$V_{CE(sat)}^*$	Collector-emitter Saturation Voltage	$I_C = -5\text{ A}$ $I_B = -1.5\text{ A}$			- 1.5	V
$V_{BE(sat)}^*$	Base-emitter Saturation Voltage	$I_C = -5\text{ A}$ $I_B = -1.5\text{ A}$			- 1.6	V
$h_{FE}^*$	DC Current Gain	$I_C = -1\text{ A}$ $V_{CE} = -5\text{ V}$	12			
$I_{S/b}$	Second Breakdown Collector Current	$V_{CE} = -30\text{ V}$ for <b>BUW32/A</b> for <b>BUW32P/AP</b> for <b>BUW32PFI/APFI</b>	- 4.2			A
$t_{on}$	Turn-on Time	Resistive Load $V_{CC} = -250\text{ V}$		0.3	0.6	μs
$t_s$	Storage Time	$I_C = -5\text{ A}$		0.7	1.5	μs
$t_f$	Fall Time	$I_{B1} = -I_{B2} = -1\text{ A}$		0.25	0.6	μs

\* Pulsed : pulse duration = 300 μs, duty cycle = 1.5 %.

**Safe Operating Areas.**

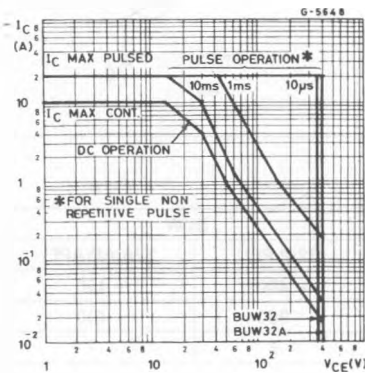

**Safe Operating Areas.**

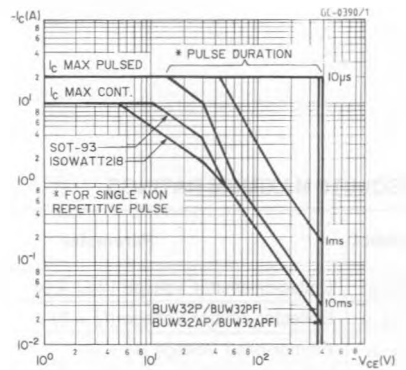

DC Current Gain.

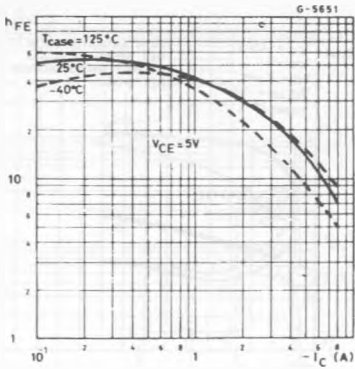

Collector-emitter Saturation Voltage.

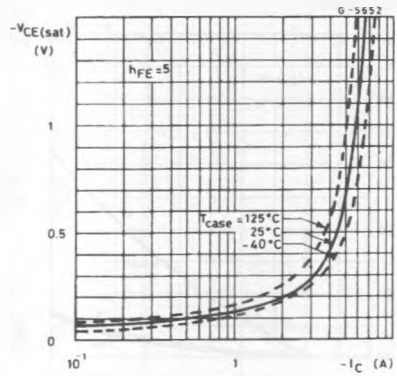

Collector-emitter Saturation Voltage.

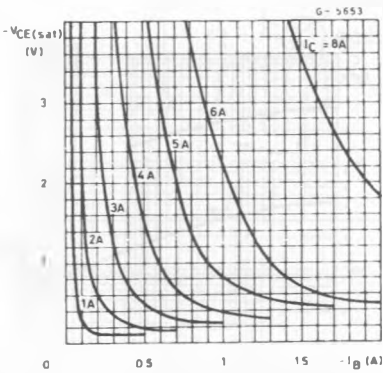

Base-emitter Saturation Voltage.

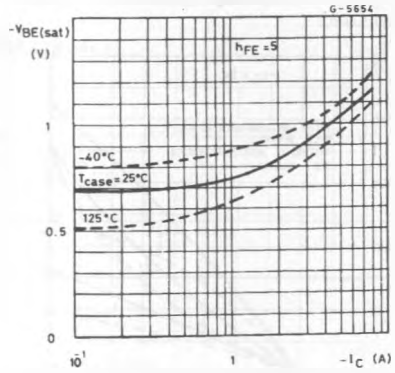

Clamped Reverse Bias Safe Operating Areas.

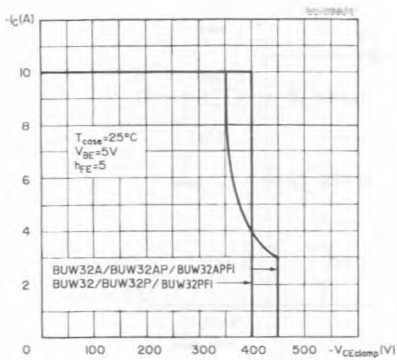

Saturated Switching Characteristics (test circuit fig. 1).

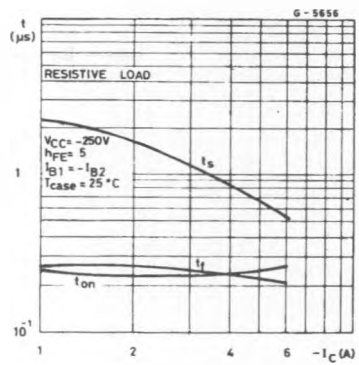

Switching Times Percentage Variation vs.  $T_{case}$  Resistive Load.

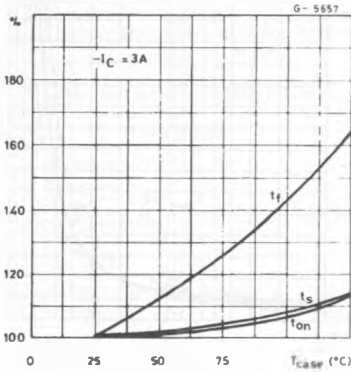

Switching Times Resistive Load (test circuit fig. 2).

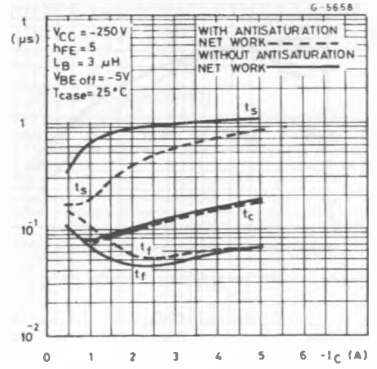

Switching Time Percentage Variation vs.  $T_{case}$  Resistive Load.

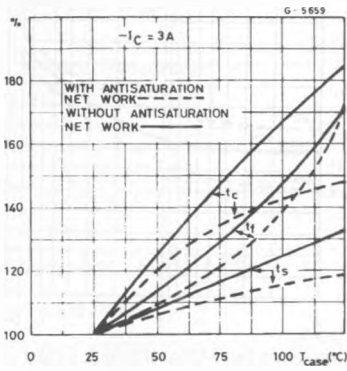

Capacitance.

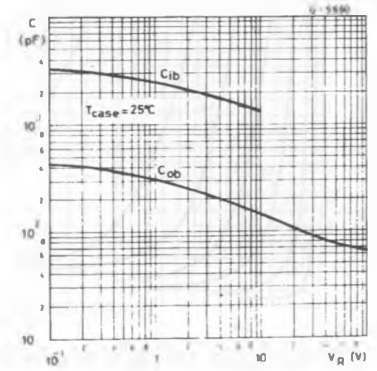

TEST CIRCUITS.

Figure 1.

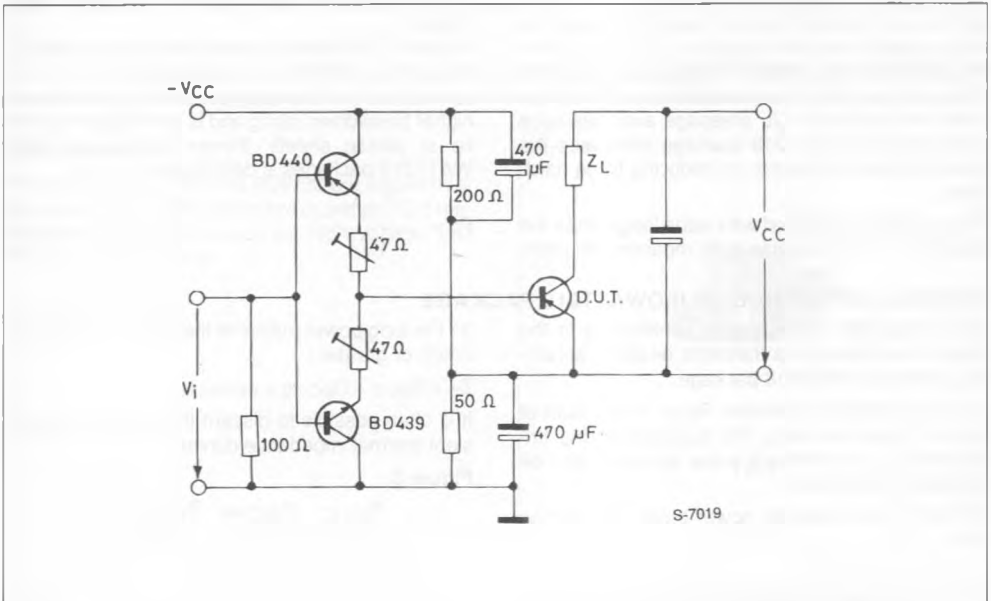
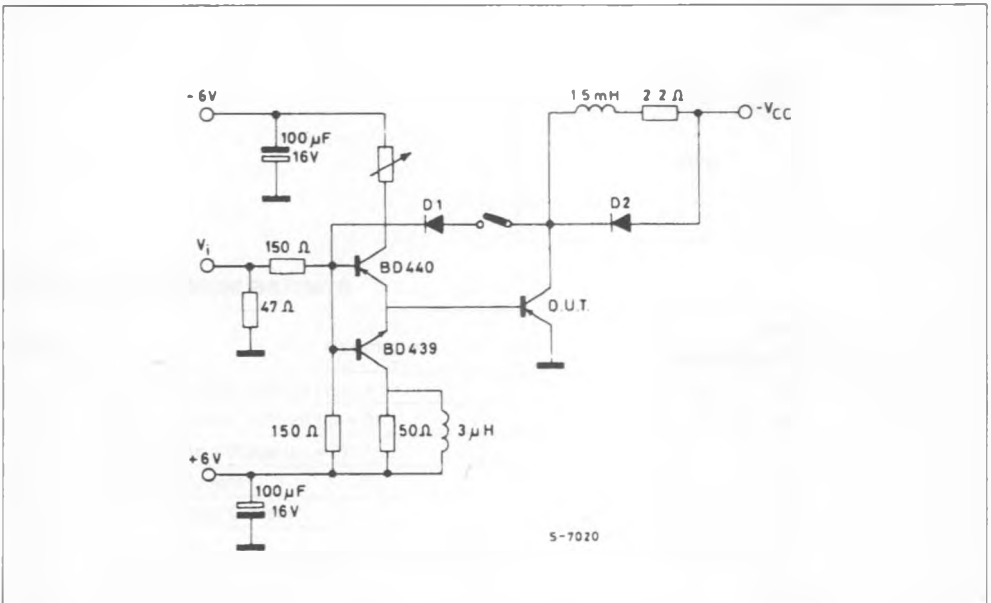

Figure 2.



**ISOWATT218 PACKAGE CHARACTERISTICS AND APPLICATION.**

ISOWATT218 is fully isolated to 4000V dc. Its thermal impedance, given in the data sheet, is optimised to give efficient thermal conduction together with excellent electrical isolation. The structure of the case ensures optimum distances between the pins and heatsink. These distances are in agreement with VDE and UL creepage and clearance standards. ISOWATT218 package eliminates the need for external isolation so reducing fixing hardware.

The package is supplied with leads longer than the standard TO-218 to allow easy mounting on pcbs.

Accurate moulding techniques used in manufacture assures consistent heat spreader-to-heatsink capacitance.

ISOWATT218 thermal performance is equivalent to that of the standard part, mounted with a 0.1mm mica washer. The thermally conductive plastic has a higher breakdown rating and is less fragile than mica or plastic sheets. Power derating for ISOWATT218 packages is determined by :

$$P_D = \frac{T_J - T_c}{R_{th}}$$

**THERMAL IMPEDANCE OF ISOWATT218 PACKAGE**

Fig. 3 illustrates the elements contributing to the thermal resistance of a transistor heatsink assembly, using ISOWATT218 package.

The total thermal resistance  $R_{th(tot)}$  is the sum of each of these elements. The transient thermal impedance,  $Z_{th}$  for different pulse durations can be estimated as follows :

1 - For a short duration power pulse of less than 1ms :

$$Z_{th} < R_{thJ-C}$$

2 - For an intermediate power pulse of 5ms to 50ms seconds :

$$Z_{th} = R_{thJ-C}$$

3 - For long power pulses of the order of 500ms seconds or greater :

$$Z_{th} = R_{thJ-C} + R_{thC-HS} + R_{thHS-amb}$$

It is often possible to discern these areas on transient thermal impedance curves.

**Figure 3.**

