

HIGH CURRENT, HIGH SPEED, HIGH POWER TRANSISTOR

DESCRIPTION

The BUX20 is a silicon multiepitaxial planar NPN transistor in modified Jeduc TO-3 metal case, intended for use in switching and linear applications in military and industrial equipment.

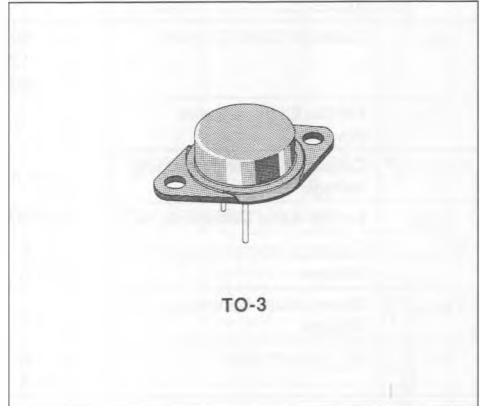

INTERNAL SCHEMATIC DIAGRAM

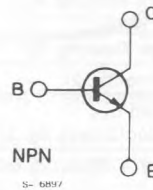

ABSOLUTE MAXIMUM RATINGS

Symbol	Parameter	Value	Unit
V_{CBO}	Collector-base Voltage ($I_E = 0$)	160	V
V_{CEX}	Collector-emitter Voltage ($V_{BE} = -1.5$ V)	160	V
V_{CEO}	Collector-emitter Voltage ($I_B = 0$)	125	V
V_{EBO}	Emitter-base Voltage ($I_C = 0$)	7	V
I_C	Collector Current	50	A
I_{CM}	Collector Peak Current ($t_p = 10$ ms)	60	A
I_B	Base Current	10	A
P_{Tot}	Total Power Dissipation at $T_{case} \leq 25$ °C	350	W
T_{stg}	Storage Temperature	- 65 to 200	°C
T_j	Junction Temperature	200	°C

THERMAL DATA

$R_{th\ j-case}$	Thermal Resistance Junction-case	Max	0.5	°C/W
------------------	----------------------------------	-----	-----	------

ELECTRICAL CHARACTERISTICS ($T_{case} = 25\text{ °C}$ unless otherwise specified)

Symbol	Parameter	Test Conditions	Min.	Typ.	Max.	Unit
I_{CEO}	Collector Cutoff Current ($I_B = 0$)	$V_{CE} = 100\text{ V}$			3	mA
I_{CEX}	Collector Cutoff Current	$V_{CE} = 160\text{ V}$ $V_{BE} = -1.5\text{ V}$ $T_{case} = 125\text{ °C}$ $V_{BE} = -1.5\text{ V}$ $V_{CE} = 160\text{ V}$			3 12	mA mA
I_{EBO}	Emitter Cutoff Current ($I_C = 0$)	$V_{EB} = 5\text{ V}$			1	mA
$V_{CEO(sus)*}$	Collector-emitter Sustaining Voltage	$I_C = 200\text{ mA}$	125			V
V_{EBO}	Emitter-base Voltage ($I_C = 0$)	$I_E = 50\text{ mA}$	7			V
$V_{CE(sat)*}$	Collector-emitter Saturation Voltage	$I_C = 25\text{ A}$ $I_B = 2.5\text{ A}$ $I_C = 50\text{ A}$ $I_B = 5\text{ A}$		0.3 0.55	0.6 1.2	V V
$V_{BE(sat)*}$	Base-emitter Saturation Voltage	$I_C = 50\text{ A}$ $I_B = 5\text{ A}$		1.35	2	V
h_{FE}^*	DC Current Gain	$I_C = 25\text{ A}$ $V_{CE} = 2\text{ V}$ $I_C = 50\text{ A}$ $V_{CE} = 4\text{ V}$	20 10		60	
$I_{S/b}$	Second Breakdown Collector Current	$V_{CE} = 40\text{ V}$ $t = 1\text{ s}$ $V_{CE} = 20\text{ V}$ $t = 1\text{ s}$	1.5 17.5			A A
f_T	Transition Frequency	$V_{CE} = 15\text{ V}$ $I_C = 2\text{ A}$ $f = 10\text{ MHz}$	8			MHz
t_{on}	Turn-on Time (fig. 2)	$I_C = 50\text{ A}$ $I_{B1} = 5\text{ A}$ $V_{CC} = 60\text{ V}$		0.4	1.5	μs
t_s	Storage Time (fig. 2)	$I_C = 50\text{ A}$ $I_{B1} = 5\text{ A}$		0.85	1.2	μs
t_f	Fall Time (fig. 2)	$I_{B2} = -5\text{ A}$ $V_{CC} = 60\text{ V}$		0.1	0.3	μs
	Clamped $E_{S/b}$ Collector Current (fig. 1)	$V_{clamp} = 125\text{ V}$ $L = 500\text{ μH}$	50			A

* Pulsed : pulse duration = 300μs, duty cycle ≤ 2%.

Safe Operating Areas.

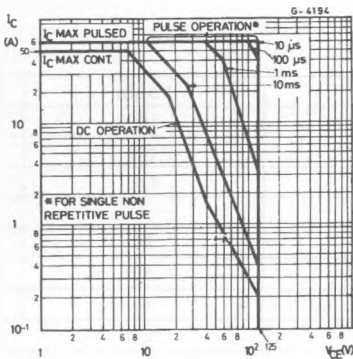

Derating Curves.

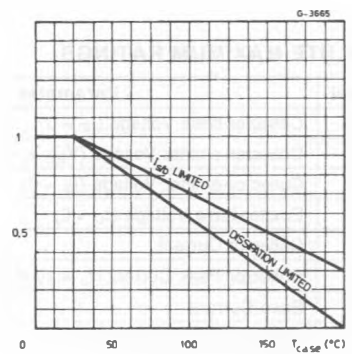

Thermal Transient Response.

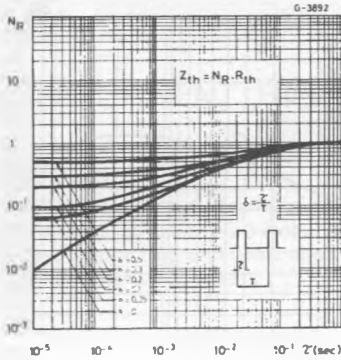

Collector-emitter Saturation Voltage.

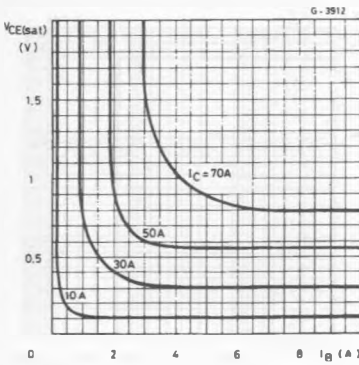

Base-emitter Saturation Voltage.

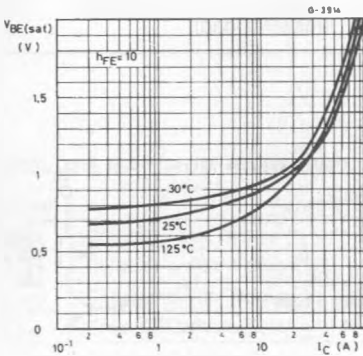

DC Current Gain.

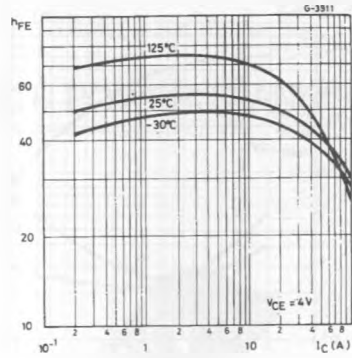

Collector-emitter Saturation Voltage.

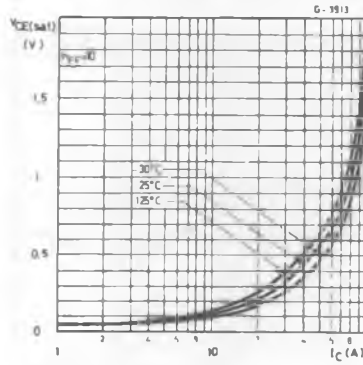

Saturated Switching Characteristics.

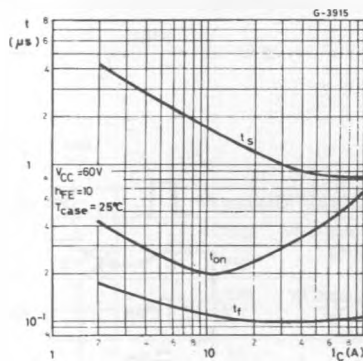

Saturated Switching Characteristics.

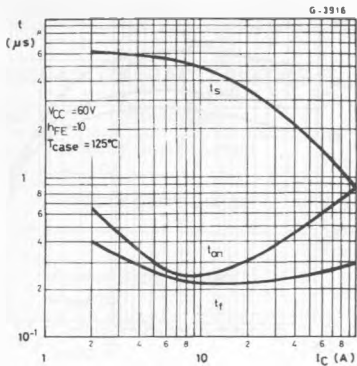

Collector-base Capacitance.

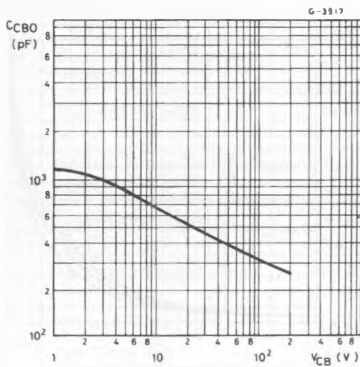
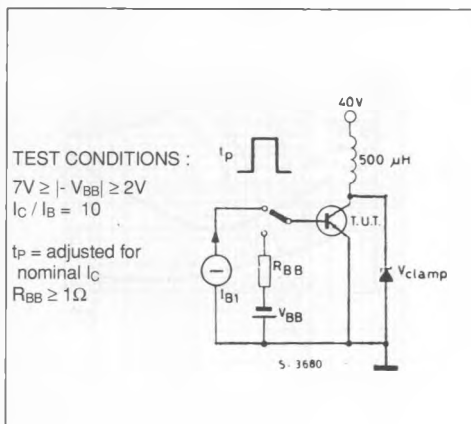
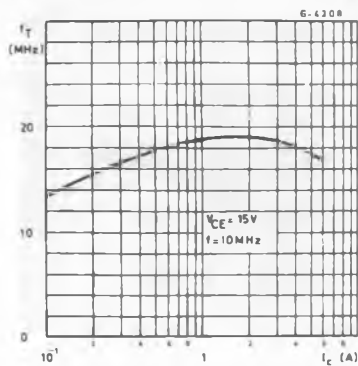

Figure 1 : Clamped $E_{s/b}$ Test Circuit.



Transition Frequency.



Clamped Reverse Bias Safe Operating Area.

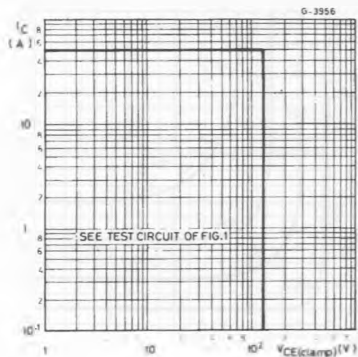

Figure 2 : Switching Times Test Circuit (resistive load).

