

HIGH VOLTAGE POWER SWITCH

DESCRIPTION

The BUX48/A, BUV48/A, and BUV48FI/AFI are multi-epitaxial mesa NPN transistors mounted respectively in TO-3 metal case, TO-218 plastic package and ISOWATT218 fully isolated package.

They are particularly intended for switching applications directly from the 220V and 380V mains.

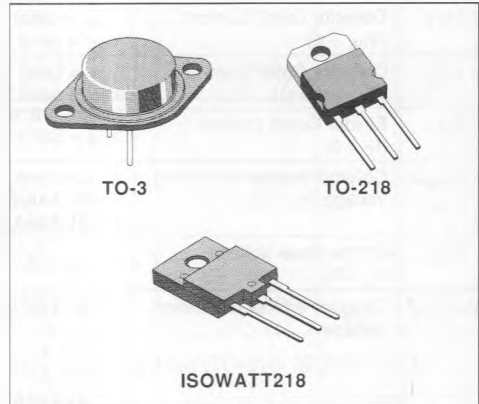

INTERNAL SCHEMATIC DIAGRAM

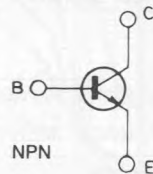

ABSOLUTE MAXIMUM RATINGS

Symbol	Parameter	Value			Unit
		BUX48 BUV48 BUV48FI	TO-218	BUX48A BUV48A BUV48AFI	
V_{CER}	Collector-emitter Voltage ($R_{BE} = 10 \Omega$)	850		1000	V
V_{CES}	Collector-emitter Voltage ($V_{BE} = 0$)	850		1000	V
V_{CEO}	Collector-emitter Voltage ($I_B = 0$)	400		450	V
V_{EBO}	Emitter-base Voltage ($I_C = 0$)		7		V
I_C	Collector Current		15		A
I_{CM}	Collector Peak Current ($t_D < 5$ ms)		30		A
I_{CP}	Collector Peak Current non Repetitive ($t_D < 20$ μ s)		55		A
I_B	Base Current		4		A
I_{BM}	Base Peak Current		20		A
		TO-3	TO-218	ISOWATT218	
P_{tot}	Total Dissipation at $T_C < 25^\circ\text{C}$	175	125	65	W
T_{stg}	Storage Temperature	- 65 to 200	- 65 to 150	- 65 to 150	$^\circ\text{C}$
T_J	Max. Operating Junction Temperature	200	125	125	$^\circ\text{C}$

THERMAL DATA

			TO-3	TO-218	ISOWATT218	
$R_{th\ j\ case}$	Thermal Resistance Junction-case	max	1	1	1.92	°C/W

ELECTRICAL CHARACTERISTICS ($T_{case} = 25\text{ °C}$ unless otherwise specified)

Symbol	Parameter	Test Conditions	Min.	Typ.	Max.	Unit
I_{CES}	Collector Cutoff Current ($V_{BE} = 0$)	$V_{CE} = \text{rated } V_{CES}$ $V_{CE} = \text{rated } V_{CES}, T_c = 125\text{ °C}$			200 2	μA mA
I_{CER}	Collector Cutoff Current ($R_{BE} = 10\ \Omega$)	$V_{CE} = \text{rated } V_{CER}$ $V_{CE} = \text{rated } V_{CER}, T_c = 125\text{ °C}$			500 4	μA mA
I_{EBO}	Emitter Cutoff Current ($I_C = 0$)	$V_{EB} = 5\text{ V}$			1	mA
$V_{CEO(sus)}$	Collector-emitter Sustaining Voltage ($I_B = 0$)	$I_C = 200\text{ mA}$ $L = 25\text{ mH}$ for BUX48/BUV48/BUV48FI for BUX48A/BUV48A/BUV48AFI	400 450			V V
V_{EBO}	Emitter-base Voltage ($I_C = 0$)	$I_E = 50\text{ mA}$	7		30	V
$V_{CE(sat)}^*$	Collector-emitter Saturation Voltage	for BUX48/BUV48/BUV48FI $I_C = 10\text{ A}$ $I_B = 2\text{ A}$ $I_C = 15\text{ A}$ $I_B = 4\text{ A}$ $I_C = 15\text{ A}$ $I_B = 3\text{ A}$ for BUX48A/BUV48A/BUV48AFI $I_C = 8\text{ A}$ $I_B = 1.6\text{ A}$ $I_C = 12\text{ A}$ $I_B = 2.4\text{ A}$			1.5 3.5 5 1.5 5	V V V V V
$V_{BE(sat)}$	Base-emitter Saturation voltage	for BUX48/BUV48/BUV48FI $I_C = 10\text{ A}$ $I_B = 2\text{ A}$ for BUX48A/BUV48A/BUV48AFI $I_C = 8\text{ A}$ $I_B = 1.6\text{ A}$			1.6 1.6	V V

* Pulsed : pulse duration = 300 μs , duty cycle $\leq 2\%$.

RESISTIVE SWITCHING TIMES (see fig. 2)

Symbol	Parameter	Test Conditions	Min.	Typ.	Max.	Unit
t_{on}	Turn-on Time	for BUX48/BUV48/BUV48FI $V_{CC} = 150\text{ V}$ $I_C = 10\text{ A}$ $I_{B1} = 2\text{ A}$ for BUX48A/BUV48A/BUV48AFI $V_{CC} = 150\text{ V}$ $I_C = 8\text{ A}$ $I_{B1} = 1.6\text{ A}$			1 1	μs μs
t_s	Storage Time	for BUX48/BUV48/BUV48FI $V_{CC} = 150\text{ V}$ $I_C = 10\text{ A}$ $I_{B1} = -I_{B2} = 2\text{ A}$ for BUX48A/BUV48A/BUV48AFI $V_{CC} = 150\text{ V}$ $I_C = 8\text{ A}$ $I_{B1} = -I_{B2} = 1.6\text{ A}$			3 3	μs μs
t_f	Fall Time	for BUX48/BUV48/BUV48FI $V_{CC} = 150\text{ V}$ $I_C = 10\text{ A}$ $I_{B1} = -I_{B2} = 2\text{ A}$ for BUX48A/BUV48A/BUV48AFI $V_{CC} = 150\text{ V}$ $I_C = 8\text{ A}$ $I_{B1} = -I_{B2} = 1.6\text{ A}$			0.8 0.8	μs μs

INDUCTIVE SWITCHING TIMES (see fig. 1)

Symbol	Parameter	Test Conditions	Min.	Typ.	Max.	Unit
t_s	Storage Time	for BUX48/BUV48/BUV48FI $V_{CC} = 300\text{ V}$, $I_C = 10\text{ A}$, $L_B = 3\text{ }\mu\text{H}$ $V_{BE} = -5\text{ V}$, $I_{B1} = 2\text{ A}$ same $T_{case} = 125\text{ }^\circ\text{C}$		2.7	5	μs μs
		for BUX48A/BUV48A/BUV48AFI $V_{CC} = 300\text{ V}$, $I_C = 8\text{ A}$, $L_B = 3\text{ }\mu\text{H}$ $V_{BE} = -5\text{ V}$, $I_{B1} = 1.6\text{ A}$ same, $T_{case} = 125\text{ }^\circ\text{C}$		3	5	μs μs
t_f	Fall Time	for BUX48/BUV48/BUV48FI $V_{CC} = 300\text{ V}$, $I_C = 10\text{ A}$, $L_B = 3\text{ }\mu\text{H}$ $V_{BE} = -5\text{ V}$, $I_{B1} = 2\text{ A}$ same $T_{case} = 125\text{ }^\circ\text{C}$		0.16	0.4	μs μs
		for BUX48A/BUV48A/BUV48AFI $V_{CC} = 300\text{ V}$, $I_C = 8\text{ A}$, $L_B = 3\text{ }\mu\text{H}$ $V_{BE} = -5\text{ V}$, $I_{B1} = 1.6\text{ A}$ same, $T_{case} = 125\text{ }^\circ\text{C}$		0.13	0.4	μs μs

Safe Operating Area (TO-3).

Safe Operating Area (TO-218, ISOWATT218).

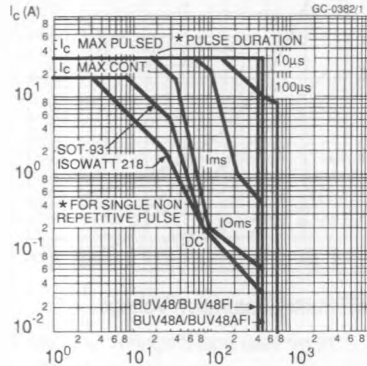
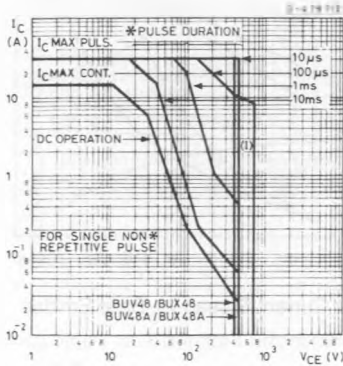

Clamped Reverse Bias Safe Operating Areas.

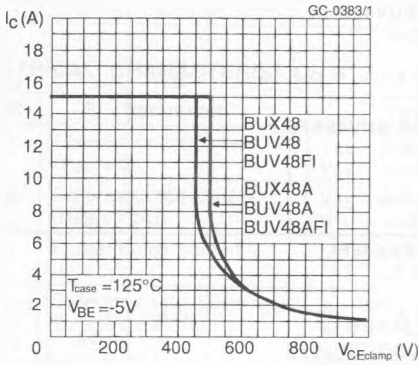

Forward Biased Accidental Overload Area. (see fig. 3).

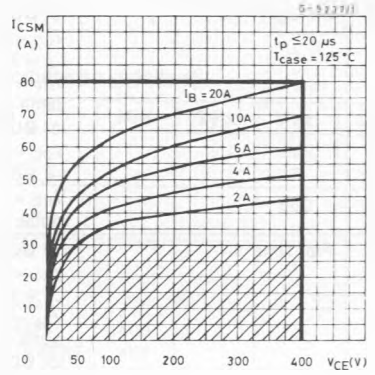

DC Current Gain..

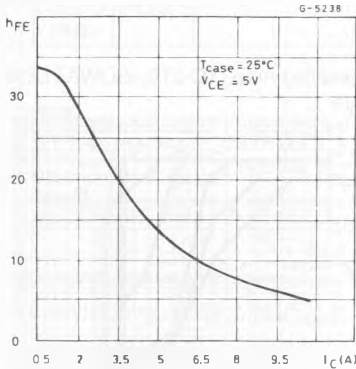

Saturation Voltage.

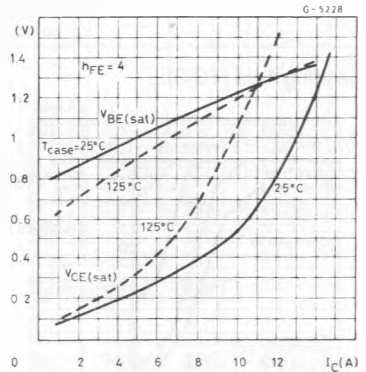

Collector-emitter Saturation Voltage.

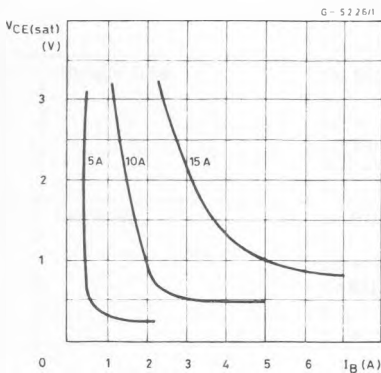

Collector Current Spread vs. Base Emitter Voltage.

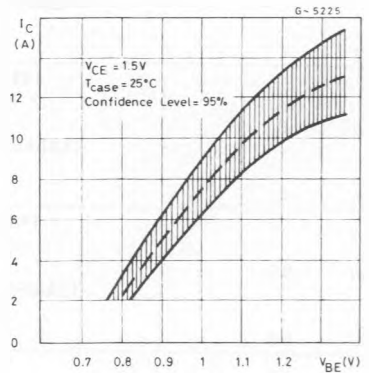

Switching Times vs. Collector Current with I_B Constant.

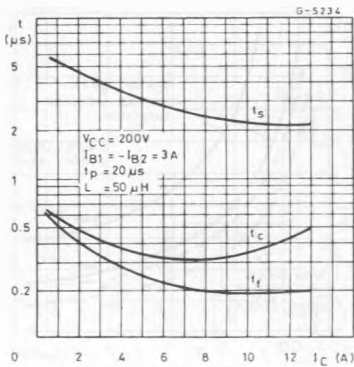

Switching Times Percentage Variation vs. Case Temperature.

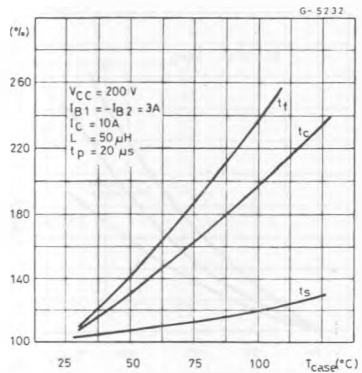

Switching Times with and without Antisaturation Network (see fig.1).

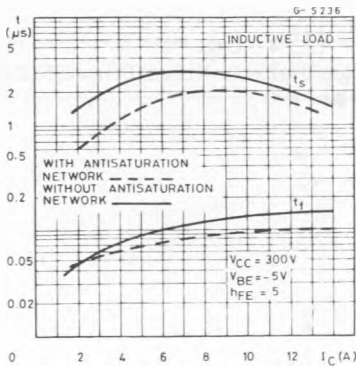

Switching Times Percentage Variation vs. Case Temperature.

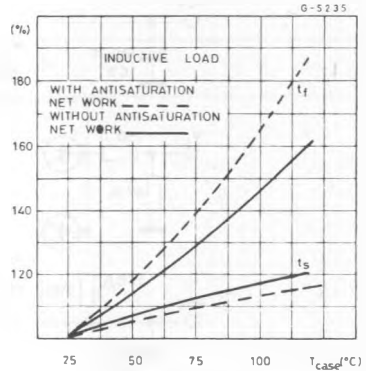

Switching Times vs. Collector Current (see fig.2).

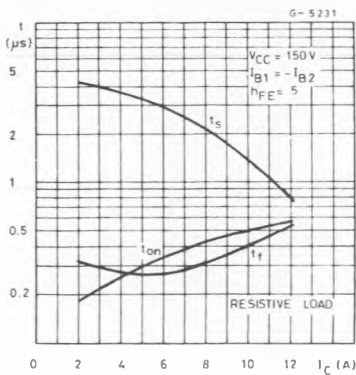

Fall Times vs. Voltage Slope (see fig.2)..

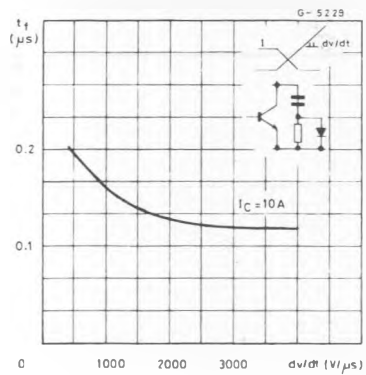

Switching Times Percentage Variation vs. Case Temperature.

Dynamic Collector-emitter Saturation Voltage (see fig. 4).

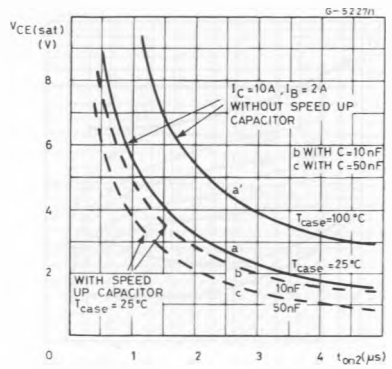
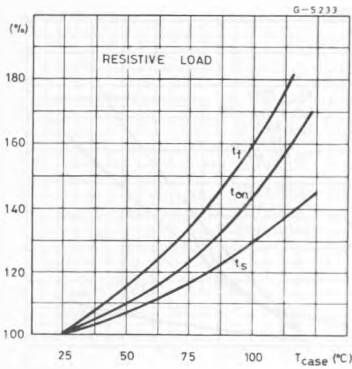

Figure 1 : Switching Times Test Circuit on Inductive Load, with and without Antisaturation Network.

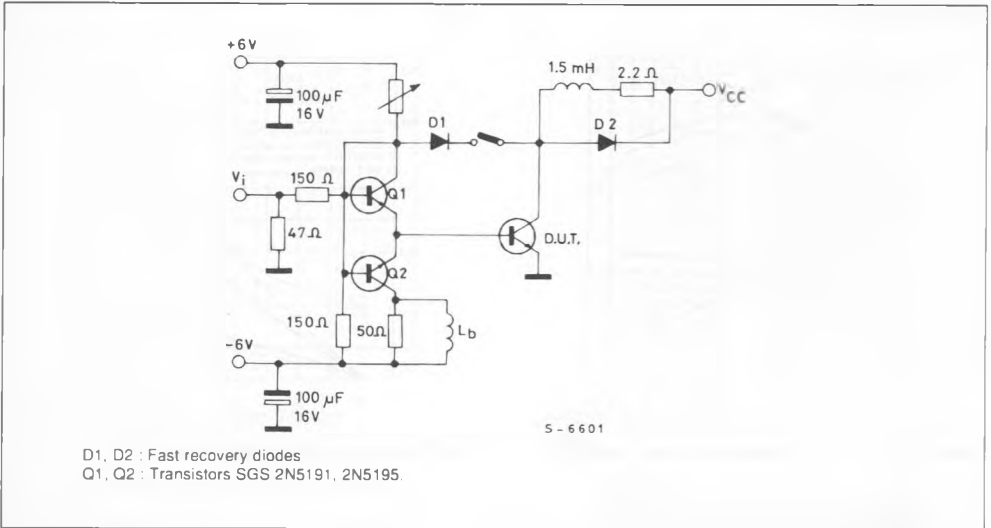

Figure 2 : Switching Times Test Circuit on resistive Load.

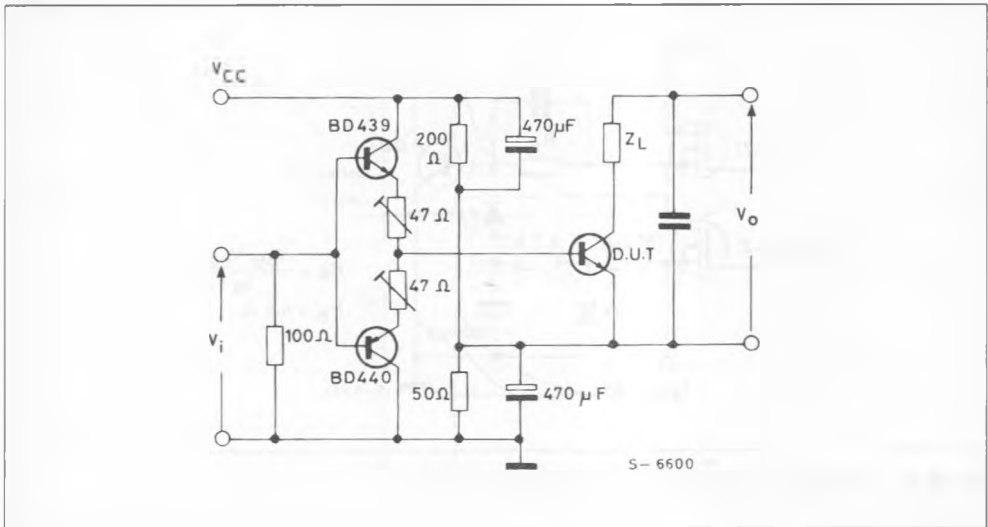

Figure 3 : Forward Biased Accidental Overload Area Test Circuit.

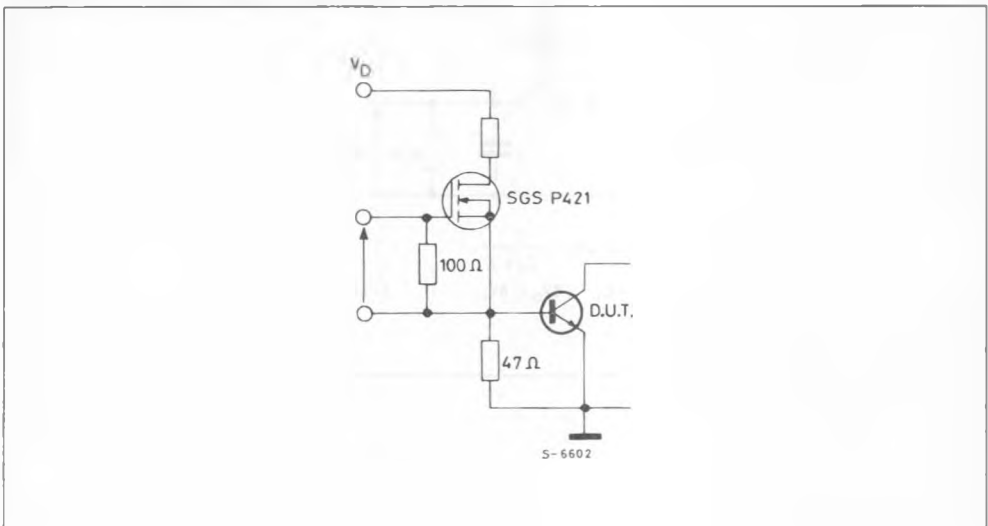

Figure 4 : $V_{CE(sat)}$ Dyn. Test Circuit.

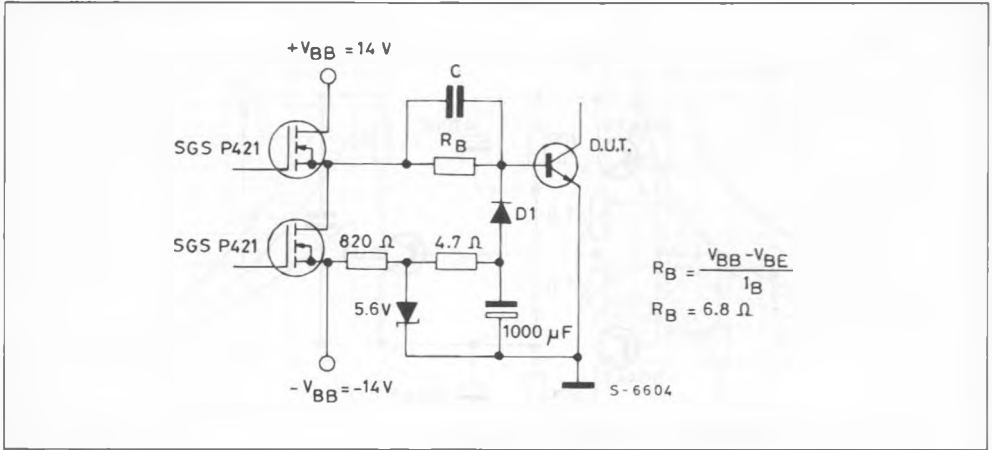

Figure 5 : Equivalent Input Schematic Circuit at Turn-on.

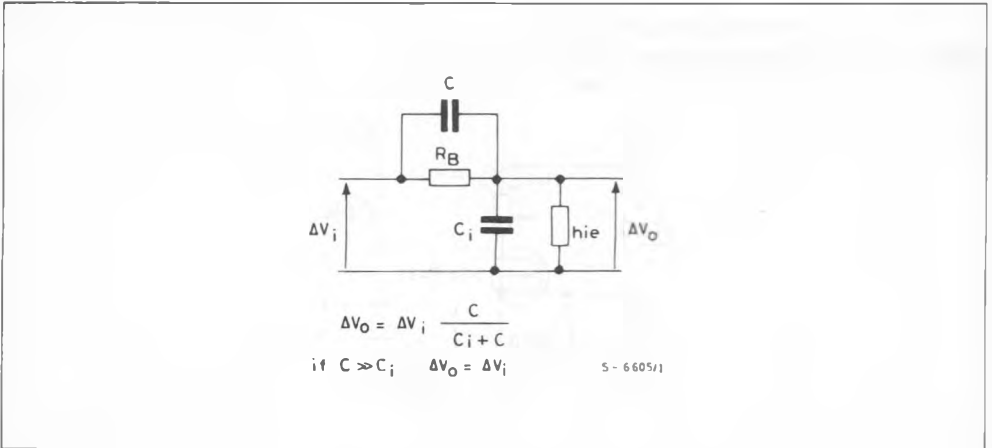
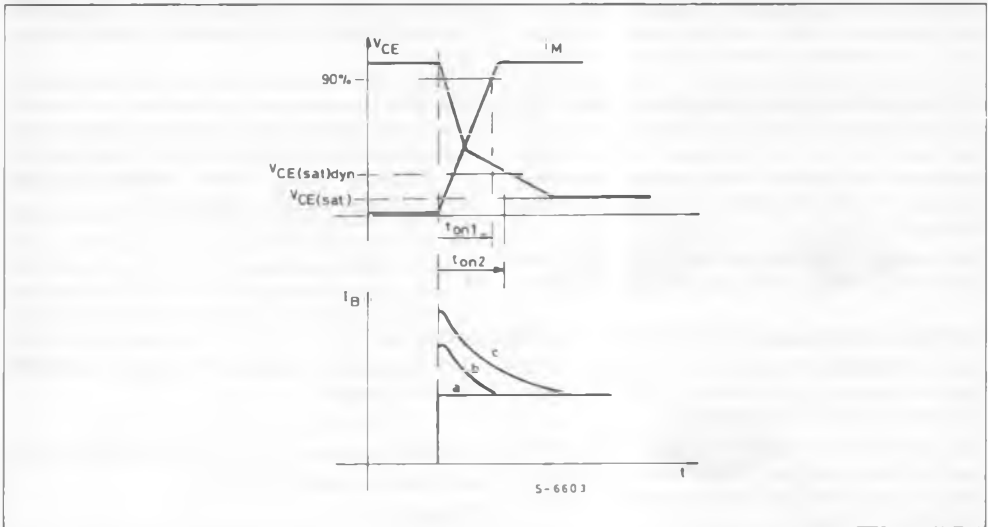

Figure 6 : Remarks to $V_{CE(sat)}$ Dyn. Test Circuit (fig.4).



The speed-up capacitor decreases the $V_{CE(sat)}$ dyn. as shown in diagram (figure 6). The 50 nF capacitor modifies the shape of base current with a overshoot.

ISOWATT218 PACKAGE CHARACTERISTICS AND APPLICATION

ISOWATT218 is fully isolated to 4000V dc. Its thermal impedance, given in the data sheet, is optimised to give efficient thermal conduction together with excellent electrical isolation. The structure of the case ensures optimum distances between the pins and heatsink. These distances are in agreement with VDE and UL creepage and clearance standards. The ISOWATT218 package eliminates the need for external isolation so reducing fixing hardware.

The package is supplied with leads longer than the standard TO-218 to allow easy mounting on pcbs.

Accurate moulding techniques used in manufacture assures consistent heat spreader-to-heatsink capacitance.

ISOWATT218 thermal performance is equivalent to that of the standard part, mounted with a 0.1 mm mica washer. The thermally conductive plastic has a higher breakdown rating and is less fragile than mica or plastic sheets. Power derating for ISOWATT218 packages is determined by :

$$P_D = \frac{T_j - T_c}{R_{th}}$$

THERMAL IMPEDANCE OF ISOWATT218 PACKAGE

Figure 6 illustrates the elements contributing to the thermal resistance of a transistor heatsink assembly, using ISOWATT218 package.

The total thermal resistance $R_{th(tot)}$ is the sum of each of these elements. The transient thermal impedance, Z_{th} for different pulse durations can be estimated as follows :

1 - For a short duration power pulse of less than 1ms :

$$Z_{th} < R_{thJ-C}$$

2 - For an intermediate power pulse of 5ms to 50ms seconds :

$$Z_{th} = R_{thJ-C}$$

3 - For long power pulses of the order of 500ms seconds or greater :

$$Z_{th} = R_{thJ-C} + R_{thC-HS} + R_{thHS-amb}$$

It is often possible to discern these areas on transient thermal impedance curves.

Figure 6.

