

DualCool™ N-Channel NexFET™ Power MOSFETs

 Check for Samples: [CSD16322Q5C](#)

FEATURES

- DualCool™ Package SON 5x6mm
- Optimized for Two Sided Cooling
- Optimized for 5V Gate Drive
- Ultralow Q_g and Q_{gd}
- Low Thermal Resistance
- Avalanche Rated
- Pb Free Terminal Plating
- RoHS Compliant and Halogen Free

APPLICATIONS

- Point-of-Load Synchronous Buck in Networking, Telecom and Computing Systems
- Optimized for Synchronous or Control FET Applications

DESCRIPTION

The NexFET™ power MOSFET has been designed to minimize losses in power conversion applications and optimized for 5V gate drive applications.

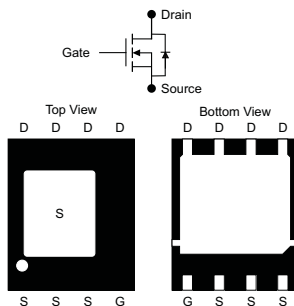

PRODUCT SUMMARY

| | | | |
|--------------|-------------------------------|-----------------|--------|
| V_{DS} | Drain to Source Voltage | 25 | V |
| Q_g | Gate Charge Total (4.5V) | 6.8 | nC |
| Q_{gd} | Gate Charge Gate to Drain | 1.3 | nC |
| $R_{DS(on)}$ | Drain to Source On Resistance | $V_{GS} = 3V$ | 5.4 mΩ |
| | | $V_{GS} = 4.5V$ | 4.6 mΩ |
| | | $V_{GS} = 8V$ | 3.9 mΩ |
| $V_{GS(th)}$ | Threshold Voltage | 1.1 | V |

ORDERING INFORMATION

| Device | Package | Media | Qty | Ship |
|-------------|----------------------------|--------------|------|---------------|
| CSD16322Q5C | SON 5x6-mm Plastic Package | 13-Inch Reel | 2500 | Tape and Reel |

ABSOLUTE MAXIMUM RATINGS

| $T_A = 25^\circ\text{C}$ unless otherwise stated | | VALUE | UNIT |
|--|---|------------|------------------|
| V_{DS} | Drain to Source Voltage | 25 | V |
| V_{GS} | Gate to Source Voltage | +10 / -8 | V |
| I_D | Continuous Drain Current, $T_C = 25^\circ\text{C}$ | 97 | A |
| | Continuous Drain Current ⁽¹⁾ | 21 | A |
| I_{DM} | Pulsed Drain Current, $T_A = 25^\circ\text{C}$ ⁽²⁾ | 136 | A |
| P_D | Power Dissipation ⁽¹⁾ | 3.1 | W |
| T_J, T_{STG} | Operating Junction and Storage Temperature Range | -55 to 150 | $^\circ\text{C}$ |
| E_{AS} | Avalanche Energy, single pulse $I_D = 50A, L = 0.1\text{mH}, R_G = 25\Omega$ | 125 | mJ |

- (1) $R_{\theta JA} = 39^\circ\text{C/W}$ on 1-inch² Cu, (2-oz.) on a 0.06" thick FR4 PCB.
 (2) Pulse duration $\leq 300\mu\text{s}$, duty cycle $\leq 2\%$

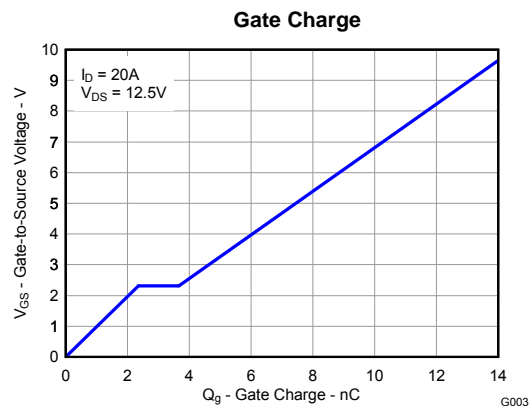
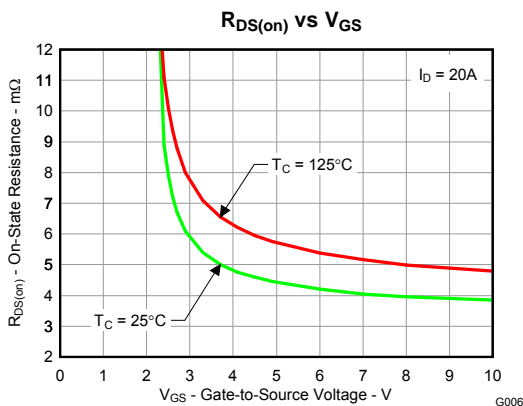

Please be aware that an important notice concerning availability, standard warranty, and use in critical applications of Texas Instruments semiconductor products and disclaimers thereto appears at the end of this data sheet.

DualCool, NexFET are trademarks of Texas Instruments.



These devices have limited built-in ESD protection. The leads should be shorted together or the device placed in conductive foam during storage or handling to prevent electrostatic damage to the MOS gates.

ELECTRICAL CHARACTERISTICS

($T_A = 25^\circ\text{C}$ unless otherwise stated)

| PARAMETER | | TEST CONDITIONS | MIN | TYP | MAX | UNIT |
|--------------------------------|----------------------------------|---|------|------|-----|------------|
| Static Characteristics | | | | | | |
| BV_{DSS} | Drain to Source Voltage | $V_{GS} = 0V, I_{DS} = 250\mu A$ | 25 | | | V |
| I_{DSS} | Drain to Source Leakage | $V_{GS} = 0V, V_{DS} = 20V$ | | | 1 | μA |
| I_{GSS} | Gate to Source Leakage | $V_{DS} = 0V, V_{GS} = +10/-8V$ | | | 100 | nA |
| $V_{GS(th)}$ | Gate to Source Threshold Voltage | $V_{DS} = V_{GS}, I_D = 250\mu A$ | 0.9 | 1.1 | 1.4 | V |
| $R_{DS(on)}$ | Drain to Source On Resistance | $V_{GS} = 3V, I_{DS} = 20A$ | | 5.4 | 7.2 | m Ω |
| | | $V_{GS} = 4.5V, I_{DS} = 20A$ | | 4.6 | 5.8 | m Ω |
| | | $V_{GS} = 8V, I_{DS} = 20A$ | | 3.9 | 5 | m Ω |
| g_{fs} | Transconductance | $V_{DS} = 15V, I_{DS} = 20A$ | | 106 | | S |
| Dynamic Characteristics | | | | | | |
| C_{iss} | Input Capacitance | $V_{GS} = 0V, V_{DS} = 12.5V,$ $f = 1MHz$ | 1050 | 1365 | | pF |
| C_{oss} | Output Capacitance | | 740 | 950 | | pF |
| C_{rss} | Reverse Transfer Capacitance | | 55 | 70 | | pF |
| R_G | Series Gate Resistance | | 1.1 | 2.2 | | Ω |
| Q_g | Gate Charge Total (4.5V) | $V_{DS} = 12.5V,$ $I_{DS} = 20A$ | 6.8 | 9.7 | | nC |
| Q_{gd} | Gate Charge – Gate to Drain | | 1.3 | | | nC |
| Q_{gs} | Gate Charge – Gate to Source | | 2.4 | | | nC |
| $Q_{g(th)}$ | Gate Charge at V_{th} | | 1.3 | | | nC |
| Q_{oss} | Output Charge | $V_{DS} = 13V, V_{GS} = 0V$ | 17 | | | nC |
| $t_{d(on)}$ | Turn On Delay Time | $V_{DS} = 12.5V, V_{GS} = 4.5V,$ $I_{DS} = 20A, R_G = 2\Omega$ | 6.1 | | | ns |
| t_r | Rise Time | | 10.7 | | | ns |
| $t_{d(off)}$ | Turn Off Delay Time | | 12.3 | | | ns |
| t_f | Fall Time | | 3.7 | | | ns |
| Diode Characteristics | | | | | | |
| V_{SD} | Diode Forward Voltage | $I_{DS} = 20A, V_{GS} = 0V$ | 0.8 | 1 | | V |
| Q_{rr} | Reverse Recovery Charge | $V_{DD} = 13V, I_F = 20A, di/dt = 300A/\mu s$ | 19 | | | nC |
| t_{rr} | Reverse Recovery Time | | 21 | | | ns |

THERMAL CHARACTERISTICS

($T_A = 25^\circ\text{C}$ unless otherwise stated)

| PARAMETER | | MIN | TYP | MAX | UNIT |
|-----------------|---|-----|-----|-----|--------------------|
| $R_{\theta JC}$ | Thermal Resistance Junction to Case (Top Source) ⁽¹⁾ | | | 3.5 | $^\circ\text{C/W}$ |
| $R_{\theta JC}$ | Thermal Resistance Junction to Case (Bottom drain) ⁽¹⁾ | | | 2.4 | $^\circ\text{C/W}$ |
| $R_{\theta JA}$ | Thermal Resistance Junction to Ambient ⁽¹⁾⁽²⁾ | | | 50 | $^\circ\text{C/W}$ |

(1) $R_{\theta JC}$ is determined with the device mounted on a 1-inch² 2-oz. Cu pad on a 1.5 × 1.5-inch 0.06-inch thick FR4 board. $R_{\theta JC}$ is specified by design, whereas $R_{\theta CA}$ is determined by the user's board design.

(2) Device mounted on FR4 material with 1-inch² of 2-oz. Cu.



M0137-01

Max $R_{\theta JA} = 50^{\circ}\text{C/W}$
when mounted on
1 inch² of 2-oz. Cu.

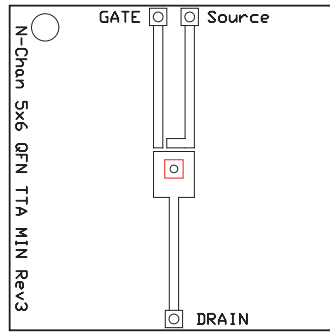

M0137-02

Max $R_{\theta JA} = 123^{\circ}\text{C/W}$
when mounted on
minimum pad area of
2-oz. Cu.

TYPICAL MOSFET CHARACTERISTICS

($T_A = 25^{\circ}\text{C}$ unless otherwise stated)

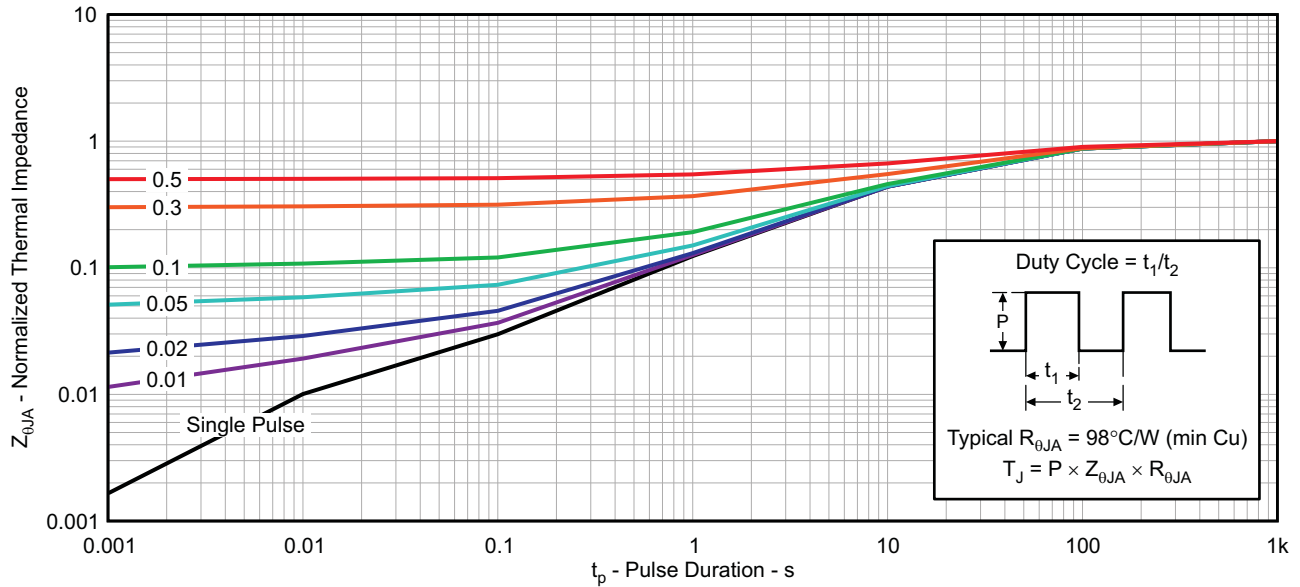

G012

Figure 1. Transient Thermal Impedance

TYPICAL MOSFET CHARACTERISTICS (continued)

($T_A = 25^\circ\text{C}$ unless otherwise stated)

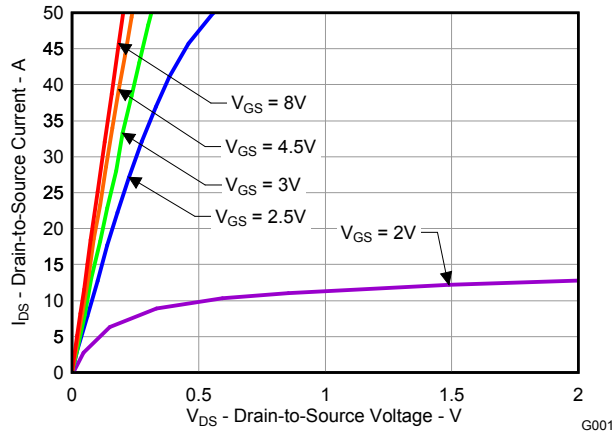

Figure 2. Saturation Characteristics

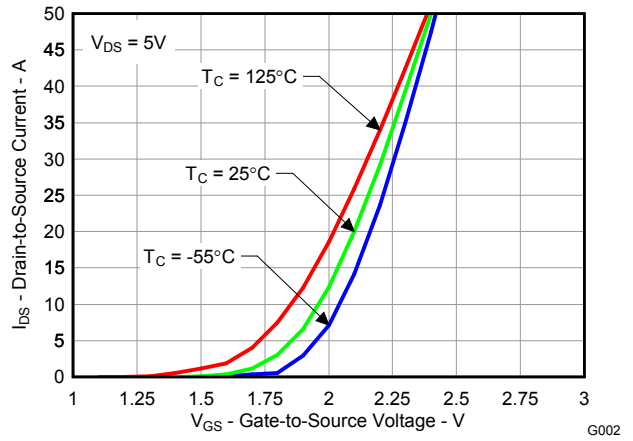

Figure 3. Transfer Characteristics

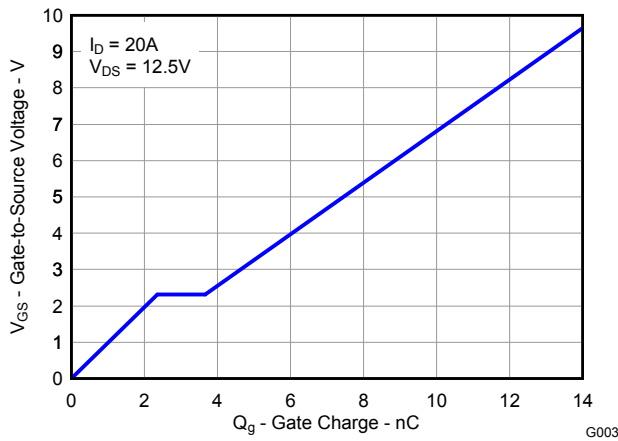

Figure 4. Gate Charge

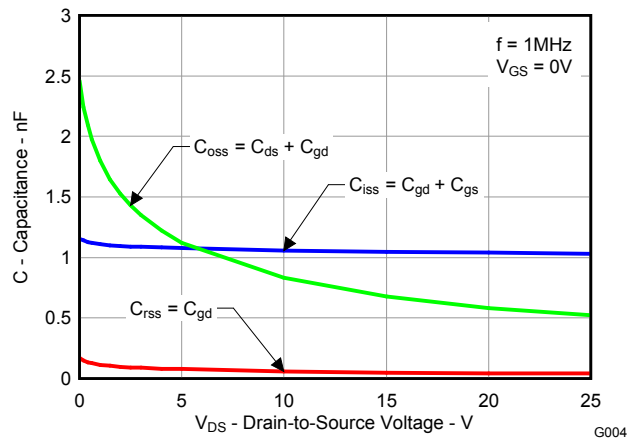

Figure 5. Capacitance

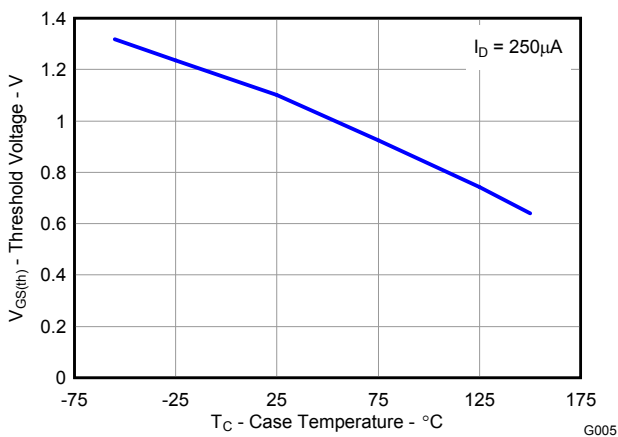

Figure 6. Threshold Voltage vs. Temperature

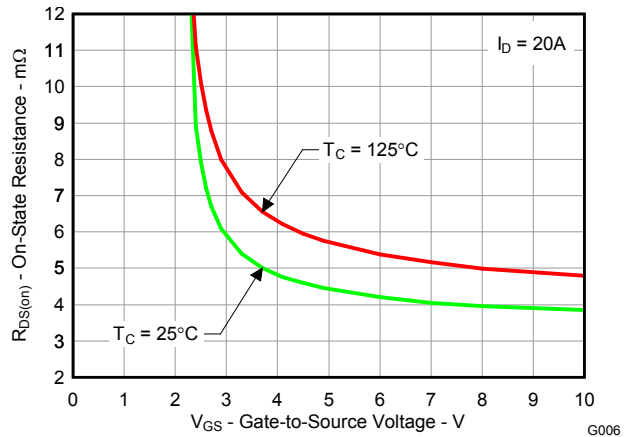

Figure 7. On Resistance vs. Gate Voltage

TYPICAL MOSFET CHARACTERISTICS (continued)

($T_A = 25^\circ\text{C}$ unless otherwise stated)

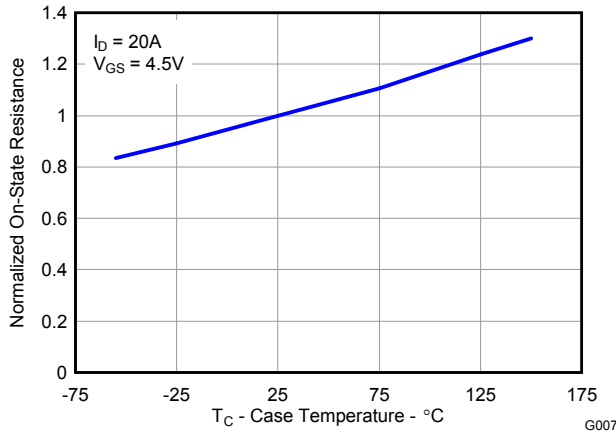

Figure 8. On Resistance vs. Temperature

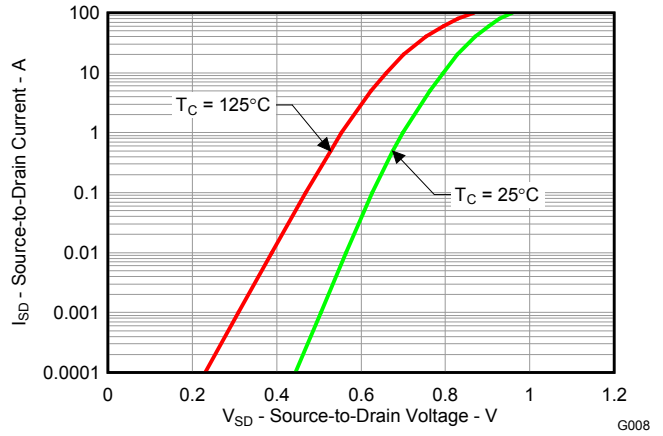

Figure 9. Typical Diode Forward Voltage

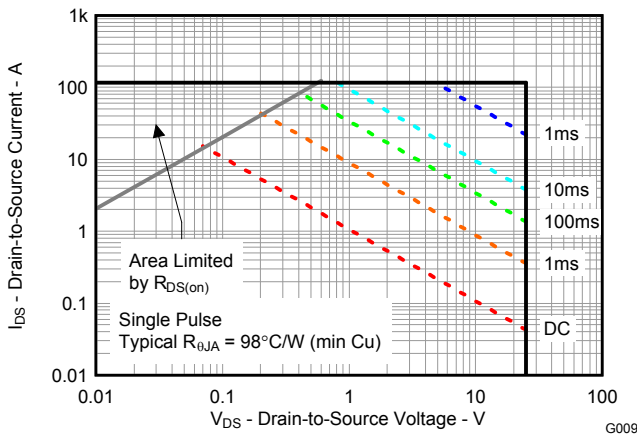

Figure 10. Maximum Safe Operating Area

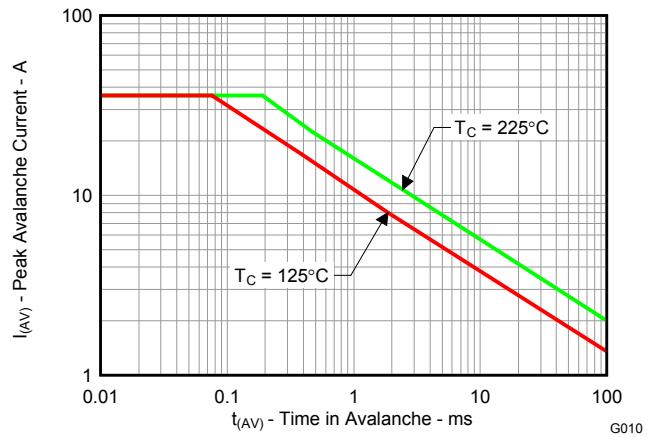

Figure 11. Single Pulse Unclamped Inductive Switching

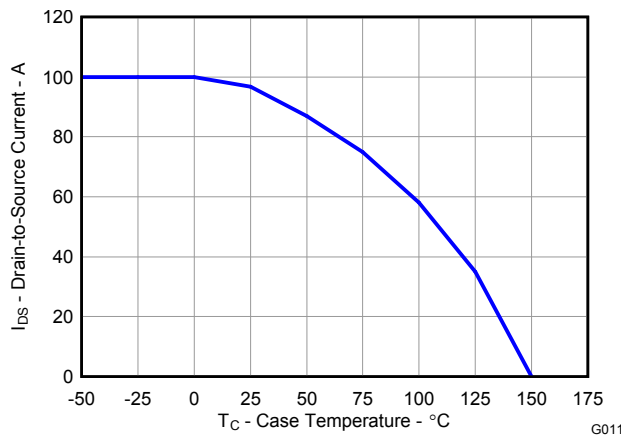
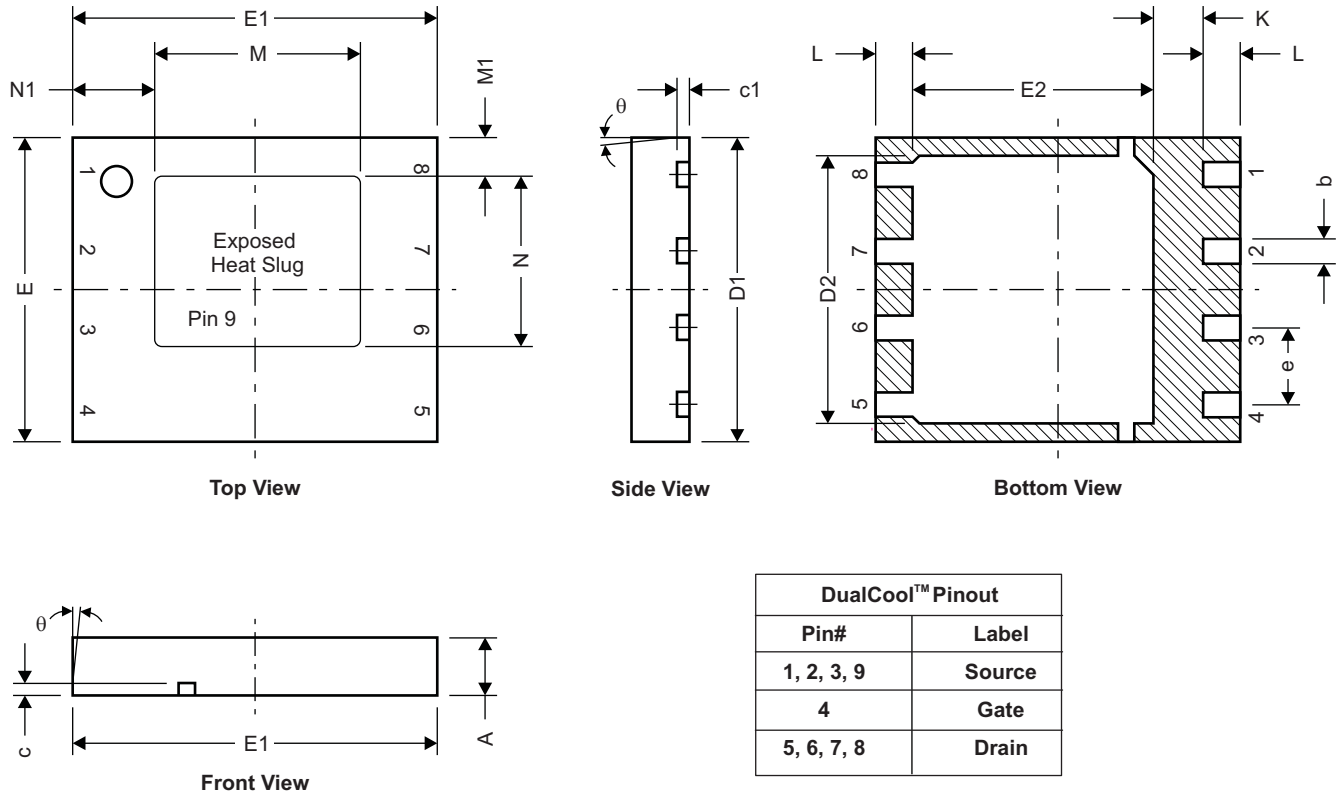

Figure 12. Maximum Drain Current vs. Temperature

MECHANICAL DATA

Q5C Package Dimensions



| DualCool™ Pinout | |
|------------------|--------|
| Pin# | Label |
| 1, 2, 3, 9 | Source |
| 4 | Gate |
| 5, 6, 7, 8 | Drain |

M0162-01

| DIM | MILLIMETERS | | INCHES | |
|-------|-------------|-------|--------|-------|
| | MIN | MAX | MIN | MAX |
| A | 0.950 | 1.050 | 0.037 | 0.039 |
| b | 0.360 | 0.460 | 0.014 | 0.018 |
| c | 0.150 | 0.250 | 0.006 | 0.010 |
| c1 | 0.150 | 0.250 | 0.006 | 0.010 |
| D1 | 4.900 | 5.100 | 0.193 | 0.201 |
| D2 | 4.320 | 4.520 | 0.170 | 0.178 |
| E | 4.900 | 5.100 | 0.193 | 0.201 |
| E1 | 5.900 | 6.100 | 0.232 | 0.240 |
| E2 | 3.920 | 4.12 | 0.154 | 0.162 |
| e | 1.27 TYP | | 0.050 | |
| L | 0.510 | 0.710 | 0.020 | 0.028 |
| theta | - | - | - | - |
| K | 0.760 | - | 0.030 | - |
| M | 3.260 | 3.460 | 0.128 | 0.136 |
| M1 | 0.520 | 0.720 | 0.020 | 0.028 |
| N | 2.720 | 2.920 | 0.107 | 0.115 |
| N1 | 1.227 | 1.427 | 0.048 | 0.056 |

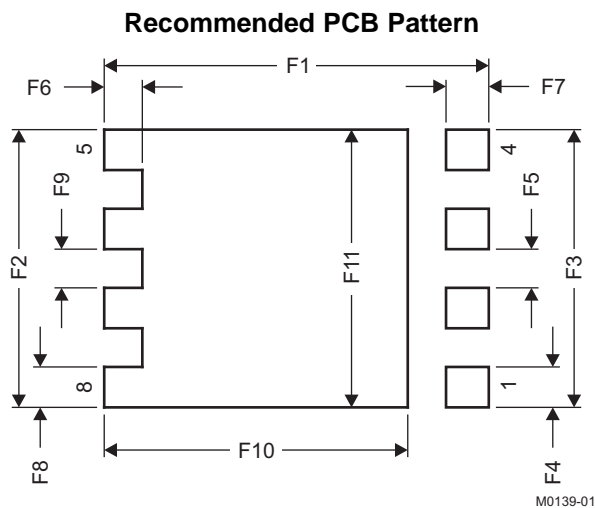

| DIM | MILLIMETERS | | INCHES | |
|-----|-------------|-------|--------|-------|
| | MIN | MAX | MIN | MAX |
| F1 | 6.205 | 6.305 | 0.244 | 0.248 |
| F2 | 4.46 | 4.56 | 0.176 | 0.18 |
| F3 | 4.46 | 4.56 | 0.176 | 0.18 |
| F4 | 0.65 | 0.7 | 0.026 | 0.028 |
| F5 | 0.62 | 0.67 | 0.024 | 0.026 |
| F6 | 0.63 | 0.68 | 0.025 | 0.027 |
| F7 | 0.7 | 0.8 | 0.028 | 0.031 |
| F8 | 0.65 | 0.7 | 0.026 | 0.028 |
| F9 | 0.62 | 0.67 | 0.024 | 0.026 |
| F10 | 4.9 | 5 | 0.193 | 0.197 |
| F11 | 4.46 | 4.56 | 0.176 | 0.18 |

For recommended circuit layout for PCB designs, see application note [SLPA005 – Reducing Ringing Through PCB Layout Techniques](#).

Q5C Tape and Reel Information

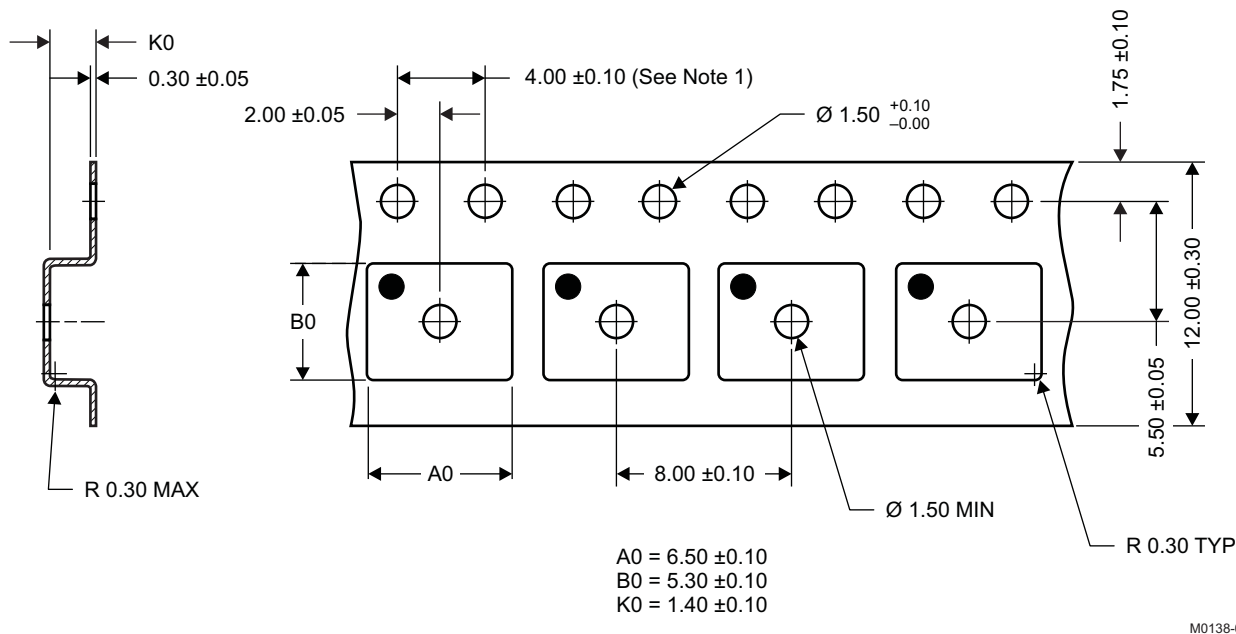

Notes:

- 10-sprocket hole-pitch cumulative tolerance ± 0.2
- Camber not to exceed 1mm in 100mm, noncumulative over 250mm
- Material: black static-dissipative polystyrene
- All dimensions are in mm, unless otherwise specified.
- A0 and B0 measured on a plane 0.3mm above the bottom of the pocket
- MSL1 260°C (IR and convection) PbF reflow compatible

REVISION HISTORY

Changes from Original (December 2009) to Revision A

Page

- Changed the labels on the Bottom View pinout image 1
- Changed the Mechanical Data dimensions table. Added dimensions for M, M1, N and N1 6

Changes from Revision A (April 2010) to Revision B

Page

- Changed $R_{DS(on)} - V_{GS} = 3V$ in the Electrical Characteristics table From: 7 To: 7.2 in the max column 2
- Deleted the Package Marking Information section 7

TAPE AND REEL INFORMATION



QUADRANT ASSIGNMENTS FOR PIN 1 ORIENTATION IN TAPE



*All dimensions are nominal

| Device | Package Type | Package Drawing | Pins | SPQ | Reel Diameter (mm) | Reel Width W1 (mm) | A0 (mm) | B0 (mm) | K0 (mm) | P1 (mm) | W (mm) | Pin1 Quadrant |
|-------------|--------------|-----------------|------|------|--------------------|--------------------|---------|---------|---------|---------|--------|---------------|
| CSD16322Q5C | SON | DQU | 8 | 2500 | 330.0 | 12.8 | 6.5 | 5.3 | 1.4 | 8.0 | 12.0 | Q1 |

TAPE AND REEL BOX DIMENSIONS



*All dimensions are nominal

| Device | Package Type | Package Drawing | Pins | SPQ | Length (mm) | Width (mm) | Height (mm) |
|-------------|--------------|-----------------|------|------|-------------|------------|-------------|
| CSD16322Q5C | SON | DQU | 8 | 2500 | 335.0 | 335.0 | 32.0 |

IMPORTANT NOTICE

Texas Instruments Incorporated and its subsidiaries (TI) reserve the right to make corrections, modifications, enhancements, improvements, and other changes to its products and services at any time and to discontinue any product or service without notice. Customers should obtain the latest relevant information before placing orders and should verify that such information is current and complete. All products are sold subject to TI's terms and conditions of sale supplied at the time of order acknowledgment.

TI warrants performance of its hardware products to the specifications applicable at the time of sale in accordance with TI's standard warranty. Testing and other quality control techniques are used to the extent TI deems necessary to support this warranty. Except where mandated by government requirements, testing of all parameters of each product is not necessarily performed.

TI assumes no liability for applications assistance or customer product design. Customers are responsible for their products and applications using TI components. To minimize the risks associated with customer products and applications, customers should provide adequate design and operating safeguards.

TI does not warrant or represent that any license, either express or implied, is granted under any TI patent right, copyright, mask work right, or other TI intellectual property right relating to any combination, machine, or process in which TI products or services are used. Information published by TI regarding third-party products or services does not constitute a license from TI to use such products or services or a warranty or endorsement thereof. Use of such information may require a license from a third party under the patents or other intellectual property of the third party, or a license from TI under the patents or other intellectual property of TI.

Reproduction of TI information in TI data books or data sheets is permissible only if reproduction is without alteration and is accompanied by all associated warranties, conditions, limitations, and notices. Reproduction of this information with alteration is an unfair and deceptive business practice. TI is not responsible or liable for such altered documentation. Information of third parties may be subject to additional restrictions.

Resale of TI products or services with statements different from or beyond the parameters stated by TI for that product or service voids all express and any implied warranties for the associated TI product or service and is an unfair and deceptive business practice. TI is not responsible or liable for any such statements.

TI products are not authorized for use in safety-critical applications (such as life support) where a failure of the TI product would reasonably be expected to cause severe personal injury or death, unless officers of the parties have executed an agreement specifically governing such use. Buyers represent that they have all necessary expertise in the safety and regulatory ramifications of their applications, and acknowledge and agree that they are solely responsible for all legal, regulatory and safety-related requirements concerning their products and any use of TI products in such safety-critical applications, notwithstanding any applications-related information or support that may be provided by TI. Further, Buyers must fully indemnify TI and its representatives against any damages arising out of the use of TI products in such safety-critical applications.

TI products are neither designed nor intended for use in military/aerospace applications or environments unless the TI products are specifically designated by TI as military-grade or "enhanced plastic." Only products designated by TI as military-grade meet military specifications. Buyers acknowledge and agree that any such use of TI products which TI has not designated as military-grade is solely at the Buyer's risk, and that they are solely responsible for compliance with all legal and regulatory requirements in connection with such use.

TI products are neither designed nor intended for use in automotive applications or environments unless the specific TI products are designated by TI as compliant with ISO/TS 16949 requirements. Buyers acknowledge and agree that, if they use any non-designated products in automotive applications, TI will not be responsible for any failure to meet such requirements.

Following are URLs where you can obtain information on other Texas Instruments products and application solutions:

Products

| | |
|-----------------------------|--|
| Audio | www.ti.com/audio |
| Amplifiers | amplifier.ti.com |
| Data Converters | dataconverter.ti.com |
| DLP® Products | www.dlp.com |
| DSP | dsp.ti.com |
| Clocks and Timers | www.ti.com/clocks |
| Interface | interface.ti.com |
| Logic | logic.ti.com |
| Power Mgmt | power.ti.com |
| Microcontrollers | microcontroller.ti.com |
| RFID | www.ti-rfid.com |
| RF/IF and ZigBee® Solutions | www.ti.com/lprf |

Applications

| | |
|-------------------------------|--|
| Communications and Telecom | www.ti.com/communications |
| Computers and Peripherals | www.ti.com/computers |
| Consumer Electronics | www.ti.com/consumer-apps |
| Energy and Lighting | www.ti.com/energy |
| Industrial | www.ti.com/industrial |
| Medical | www.ti.com/medical |
| Security | www.ti.com/security |
| Space, Avionics and Defense | www.ti.com/space-avionics-defense |
| Transportation and Automotive | www.ti.com/automotive |
| Video and Imaging | www.ti.com/video |
| Wireless | www.ti.com/wireless-apps |

TI E2E Community Home Page

e2e.ti.com

Mailing Address: Texas Instruments, Post Office Box 655303, Dallas, Texas 75265
Copyright © 2011, Texas Instruments Incorporated