



## N-Channel NexFET™ Power MOSFETs

 Check for Samples: **CSD16403Q5A**

### FEATURES

- Ultra Low  $Q_g$  and  $Q_{gd}$
- Low Thermal Resistance
- Avalanche Rated
- Pb Free Terminal Plating
- RoHS Compliant
- Halogen Free
- SON 5mm x 6mm Plastic Package

### APPLICATIONS

- Point-of-Load Synchronous Buck Converter for Applications in Networking, Telecom and Computing Systems
- Optimized for Control FET Applications

### DESCRIPTION

The NexFET™ power MOSFET has been designed to minimize losses in power conversion applications.

Top View

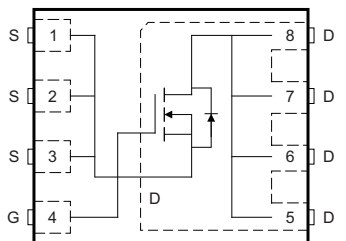

P0093-01

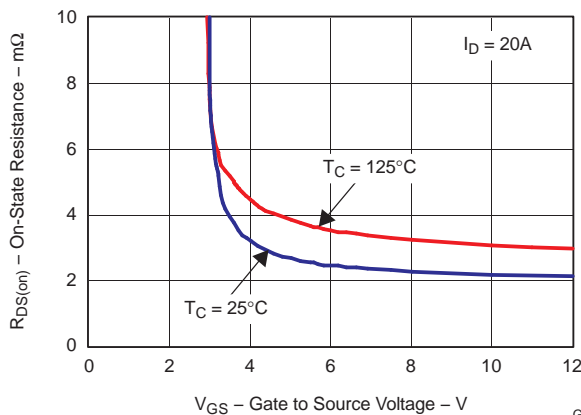
 **$R_{DS(ON)}$  vs  $V_{GS}$** 

G006

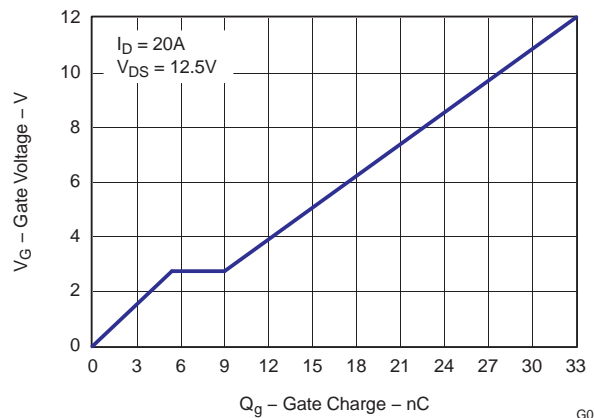
**Gate Charge**

G003

### PRODUCT SUMMARY

$V_{DS}$	Drain to Source Voltage	25	V
$Q_g$	Gate Charge Total (4.5V)	13.3	nC
$Q_{gd}$	Gate Charge Gate to Drain	3.5	nC
$R_{DS(on)}$	Drain to Source On Resistance	$V_{GS} = 4.5V$	2.9 mΩ
		$V_{GS} = 10V$	2.2 mΩ
$V_{GS(th)}$	Threshold Voltage	1.6	V

### ORDERING INFORMATION

Device	Package	Media	Qty	Ship
CSD16403Q5A	SON 5X6 Plastic Package	13-inch reel	2500	Tape and Reel

### ABSOLUTE MAXIMUM RATINGS

$T_A = 25^\circ\text{C}$ unless otherwise stated		VALUE	UNIT
$V_{DS}$	Drain to Source Voltage	25	V
$V_{GS}$	Gate to Source Voltage	+16 / -12	V
$I_D$	Continuous Drain Current, $T_C = 25^\circ\text{C}$	100	A
	Continuous Drain Current <sup>(1)</sup>	28	A
$I_{DM}$	Pulsed Drain Current, $T_A = 25^\circ\text{C}$ <sup>(2)</sup>	184	A
$P_D$	Power Dissipation <sup>(1)</sup>	3.1	W
$T_J, T_{STG}$	Operating Junction and Storage Temperature Range	-55 to 150	$^\circ\text{C}$
$E_{AS}$	Avalanche Energy, single pulse $I_D = 67A, L = 0.1\text{mH}, R_G = 25\Omega$	224	mJ

 (1)  $R_{\theta JA} = 41^\circ\text{C/W}$  on 1in<sup>2</sup> Cu FR4 PCB.

 (2) Pulse width  $\leq 300\mu\text{s}$ , duty cycle  $\leq 2\%$ 

Please be aware that an important notice concerning availability, standard warranty, and use in critical applications of Texas Instruments semiconductor products and disclaimers thereto appears at the end of this data sheet.

NexFET is a trademark of Texas Instruments.



These devices have limited built-in ESD protection. The leads should be shorted together or the device placed in conductive foam during storage or handling to prevent electrostatic damage to the MOS gates.

## ELECTRICAL CHARACTERISTICS

( $T_A = 25^\circ\text{C}$  unless otherwise stated)

PARAMETER		TEST CONDITIONS	MIN	TYP	MAX	UNIT
<b>Static Characteristics</b>						
$V_{DSS}$	Drain to Source Voltage	$V_{GS} = 0V, I_D = 250\mu A$	25			V
$I_{DSS}$	Drain to Source Leakage Current	$V_{GS} = 0V, V_{DS} = 20V$			1	$\mu A$
$I_{GSS}$	Gate to Source Leakage Current	$V_{DS} = 0V, V_{GS} = +16/-12V$			100	nA
$V_{GS(th)}$	Gate to Source Threshold Voltage	$V_{DS} = V_{GS}, I_D = 250\mu A$	1.2	1.6	1.9	V
$R_{DS(on)}$	Drain to Source On Resistance	$V_{GS} = 4.5V, I_D = 20A$		2.9	3.7	m $\Omega$
		$V_{GS} = 10V, I_D = 20A$		2.2	2.8	m $\Omega$
$g_{fs}$	Transconductance	$V_{DS} = 15V, I_D = 20A$		91		S
<b>Dynamic Characteristics</b>						
$C_{ISS}$	Input Capacitance	$V_{GS} = 0V, V_{DS} = 12.5V, f = 1MHz$		2040	2660	pF
$C_{OSS}$	Output Capacitance			1600	2080	pF
$C_{RSS}$	Reverse Transfer Capacitance			115	160	pF
$R_g$	Series Gate Resistance			1.2	2.4	$\Omega$
$Q_g$	Gate Charge Total (4.5V)	$V_{DS} = 12.5V, I_D = 20A$		13.3	18	nC
$Q_{gd}$	Gate Charge Gate to Drain			3.5		nC
$Q_{gs}$	Gate Charge Gate to Source			5.5		nC
$Q_{g(th)}$	Gate Charge at $V_{th}$			3.1		nC
$Q_{OSS}$	Output Charge	$V_{DS} = 13.5V, V_{GS} = 0V$		33		nC
$t_{d(on)}$	Turn On Delay Time	$V_{DS} = 12.5V, V_{GS} = 4.5V, I_D = 20A, R_G = 2\Omega$		11.8		ns
$t_r$	Rise Time			18.3		ns
$t_{d(off)}$	Turn Off Delay Time			15.2		ns
$t_f$	Fall Time			9.2		ns
<b>Diode Characteristics</b>						
$V_{SD}$	Diode Forward Voltage	$I_S = 20A, V_{GS} = 0V$		0.8	1.0	V
$Q_{rr}$	Reverse Recovery Charge	$V_{DD} = 13.5V, I_F = 20A, di/dt = 300A/\mu s$		47		nC
$t_{rr}$	Reverse Recovery Time	$V_{DD} = 13.5V, I_F = 20A, di/dt = 300A/\mu s$		35		ns

## THERMAL CHARACTERISTICS

( $T_A = 25^\circ\text{C}$  unless otherwise stated)

PARAMETER		MIN	TYP	MAX	UNIT
$R_{\theta JC}$	Thermal Resistance Junction to Case <sup>(1)</sup>			1.8	$^\circ\text{C/W}$
$R_{\theta JA}$	Thermal Resistance Junction to Ambient <sup>(1) (2)</sup>			51	$^\circ\text{C/W}$

(1)  $R_{\theta JC}$  is determined with the device mounted on a 1 inch square 2 oz. Cu pad on a 1.5 x 1.5 in 0.060 inch thick FR4 board.  $R_{\theta JC}$  is specified by design while  $R_{\theta JA}$  is determined by the user's board design.

(2) Device mounted on FR4 Material with 1 inch<sup>2</sup> of 2 oz. Cu.



M0137-01

Max  $R_{\theta JA} = 51^{\circ}\text{C/W}$   
when mounted on 1  
 $\text{inch}^2$  of 2 oz. Cu.

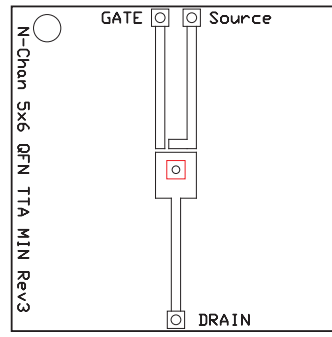

M0137-02

Max  $R_{\theta JA} = 118^{\circ}\text{C/W}$   
when mounted on  
minimum pad area of 2  
oz. Cu.

### TYPICAL MOSFET CHARACTERISTICS

( $T_A = 25^{\circ}\text{C}$  unless otherwise stated)

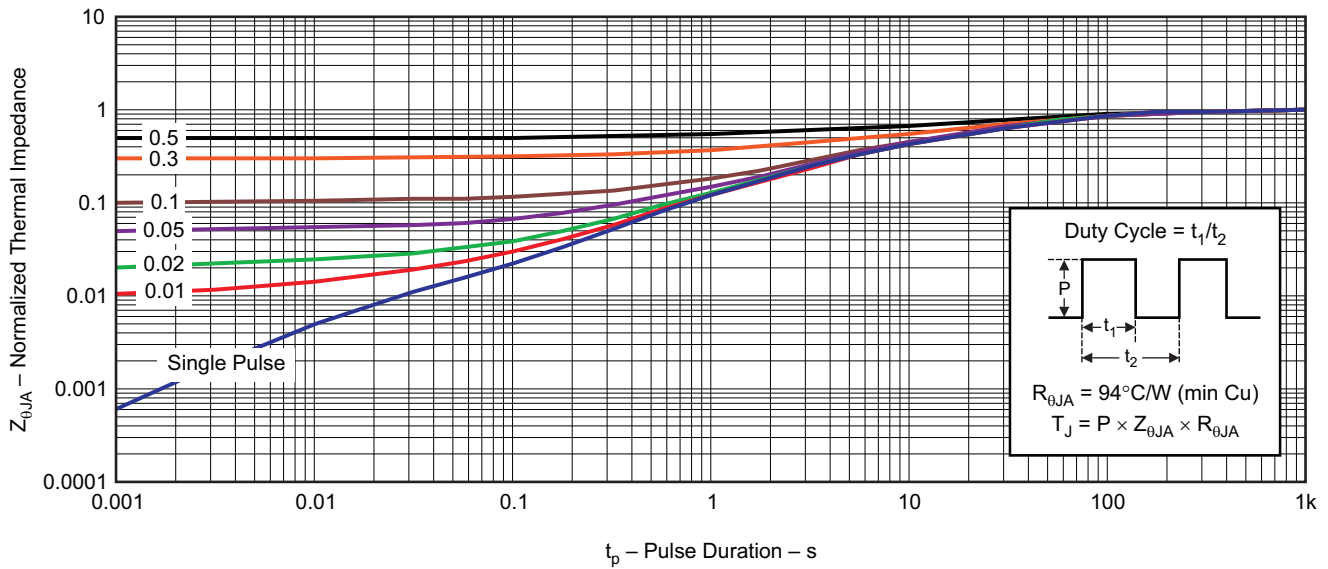

G012

Figure 1. Transient Thermal Impedance

**TYPICAL MOSFET CHARACTERISTICS (continued)**

( $T_A = 25^\circ\text{C}$  unless otherwise stated)

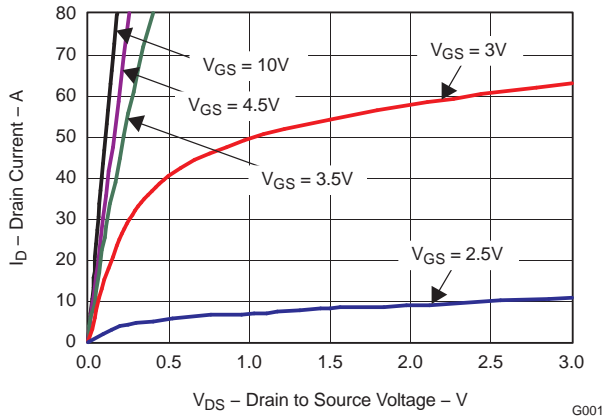

**Figure 2. Saturation Characteristics**

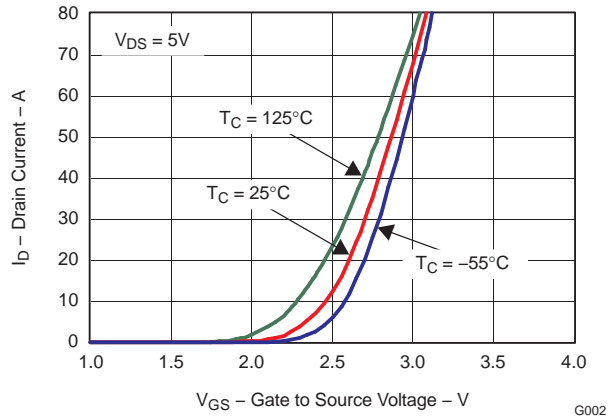

**Figure 3. Transfer Characteristics**

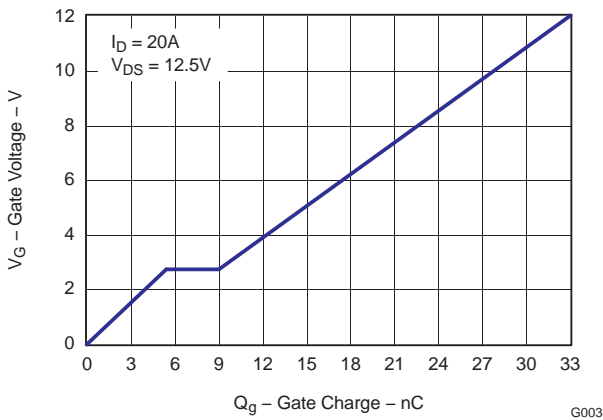

**Figure 4. Gate Charge**

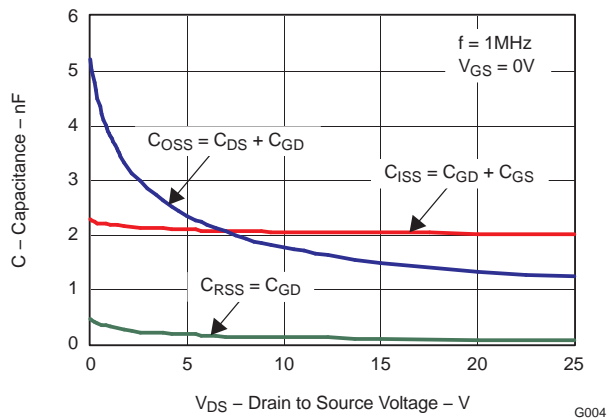

**Figure 5. Capacitance**

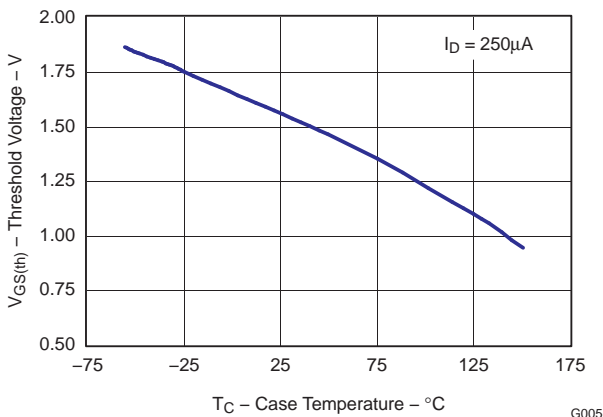

**Figure 6. Threshold Voltage vs Temperature**

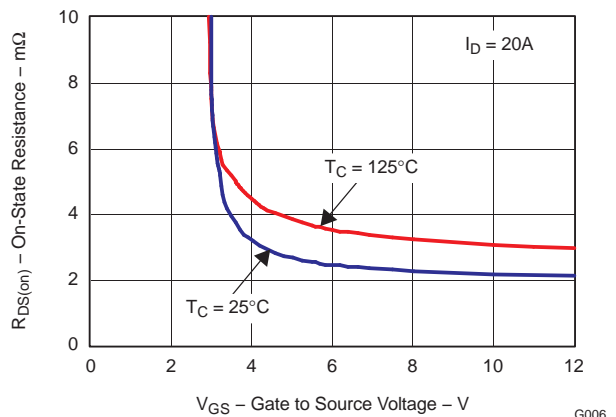

**Figure 7. On Resistance vs Gate Voltage**

TYPICAL MOSFET CHARACTERISTICS (continued)

( $T_A = 25^\circ\text{C}$  unless otherwise stated)

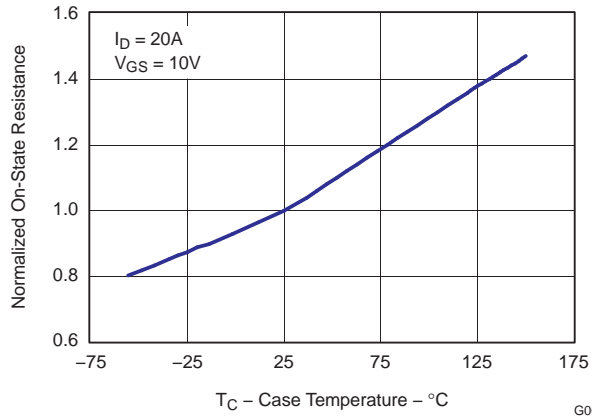

Figure 8. On Resistance vs Temperature

G007

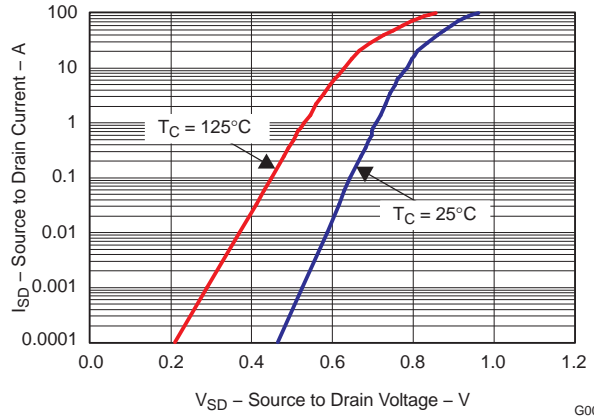

Figure 9. Typical Diode Forward Voltage

G008

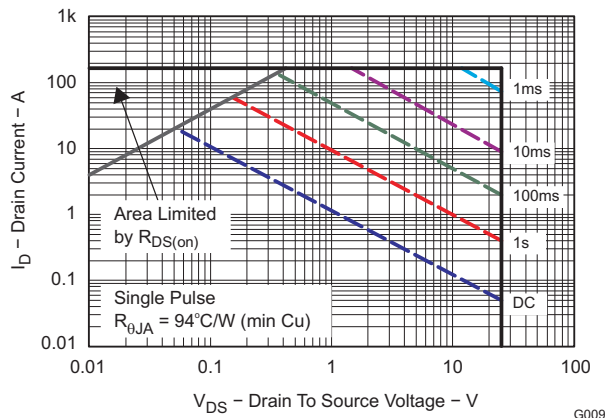

Figure 10. Maximum Safe Operating Area

G009

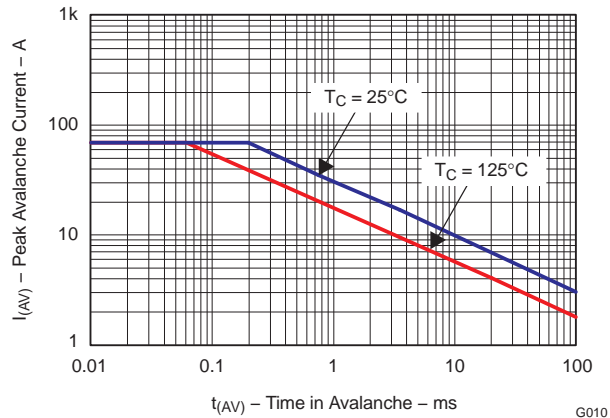

Figure 11. Single Pulse Unclamped Inductive Switching

G010

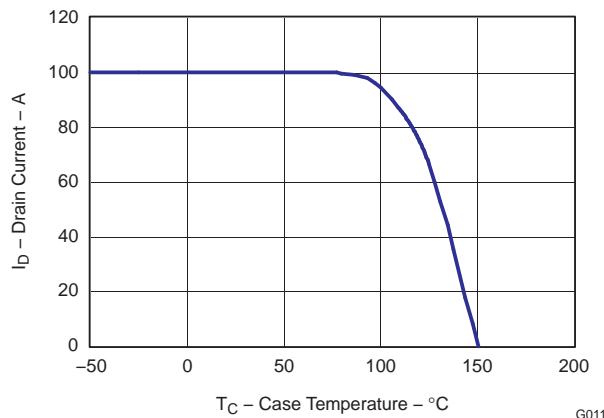

Figure 12. Maximum Drain Current vs Temperature

G011

**MECHANICAL DATA**

**Q5A Package Dimensions**



M0135-01

DIM	MILLIMETERS		
	MIN	NOM	MAX
A	0.90	1.00	1.10
b	0.33	0.41	0.51
c	0.20	0.25	0.30
D1	4.80	4.90	5.00
D2	3.61	3.81	3.96
E	5.90	6.00	6.10
E1	5.70	5.75	5.80
E2	3.38	3.58	3.78
e	1.27 BSC		
H	0.41	0.51	0.61
K	1.10		
L	0.51	0.61	0.71
L1	0.06	0.13	0.20
$\theta$	0°		12°

For recommended circuit layout for PCB designs, see application note [SLPA005 – Reducing Ringing Through PCB Layout Techniques](#).

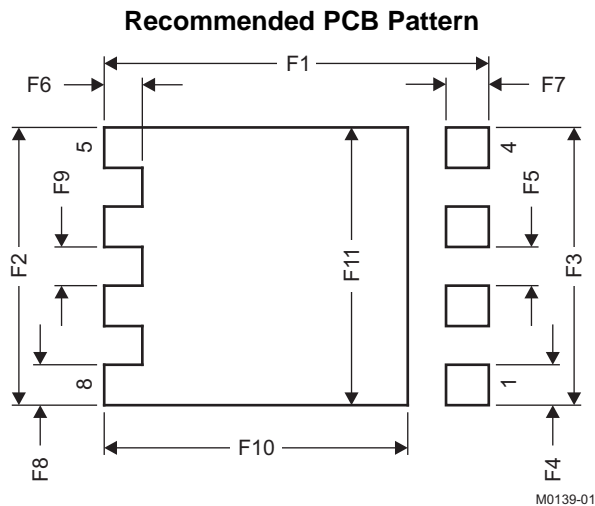

DIM	MILLIMETERS		INCHES	
	MIN	MAX	MIN	MAX
F1	6.205	6.305	0.244	0.248
F2	4.46	4.56	0.176	0.18
F3	4.46	4.56	0.176	0.18
F4	0.65	0.7	0.026	0.028
F5	0.62	0.67	0.024	0.026
F6	0.63	0.68	0.025	0.027
F7	0.7	0.8	0.028	0.031
F8	0.65	0.7	0.026	0.028
F9	0.62	0.67	0.024	0.026
F10	4.9	5	0.193	0.197
F11	4.46	4.56	0.176	0.18

**Q5A Tape and Reel Information**

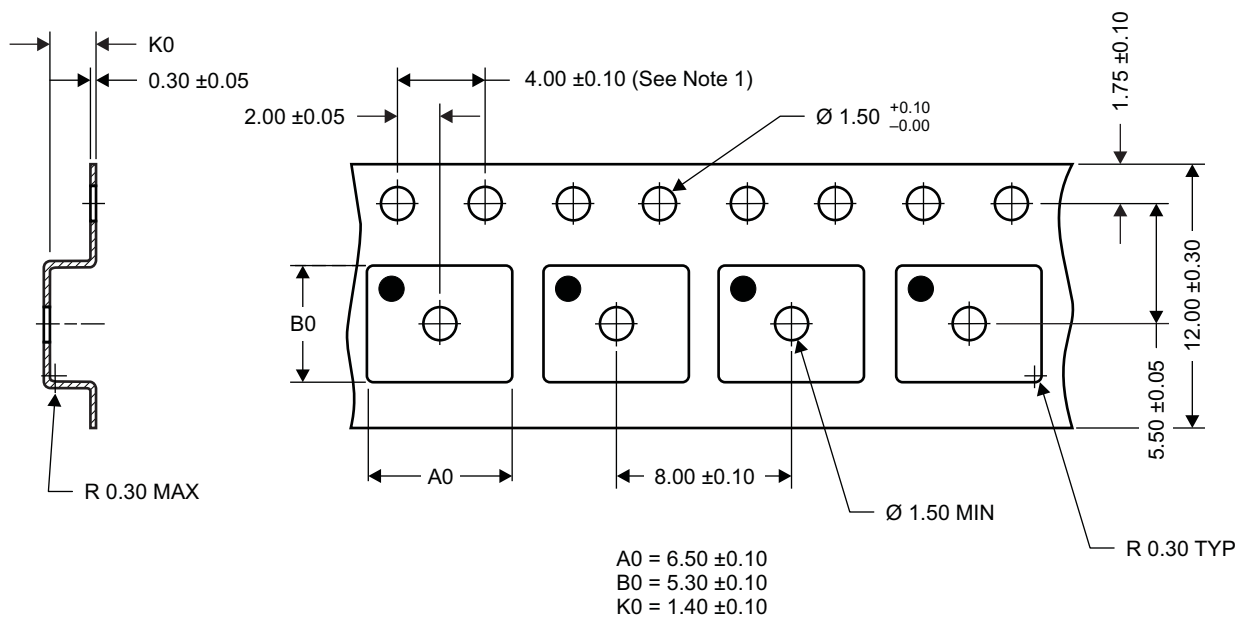

**Notes:**

1. 10 sprocket hole pitch cumulative tolerance ±0.2
2. Camber not to exceed 1mm IN 100mm, noncumulative over 250mm
3. Material:black static dissipative polystyrene
4. All dimensions are in mm (unless otherwise specified)
5. A0 and B0 measured on a plane 0.3mm above the bottom of the pocket
6. MSL1 260°C (IR and Convection) PbF Reflow Compatible

**REVISION HISTORY**

**Changes from Original (August 2009) to Revision A**

**Page**

- Deleted the Package Marking Information section ..... 7

## TAPE AND REEL INFORMATION



### QUADRANT ASSIGNMENTS FOR PIN 1 ORIENTATION IN TAPE



\*All dimensions are nominal

Device	Package Type	Package Drawing	Pins	SPQ	Reel Diameter (mm)	Reel Width W1 (mm)	A0 (mm)	B0 (mm)	K0 (mm)	P1 (mm)	W (mm)	Pin1 Quadrant
CSD16403Q5A	SON	DQJ	8	2500	330.2	12.4	6.5	5.3	1.4	8.0	12.0	Q1



**TAPE AND REEL BOX DIMENSIONS**



\*All dimensions are nominal

Device	Package Type	Package Drawing	Pins	SPQ	Length (mm)	Width (mm)	Height (mm)
CSD16403Q5A	SON	DQJ	8	2500	347.0	342.0	55.0

## IMPORTANT NOTICE

Texas Instruments Incorporated and its subsidiaries (TI) reserve the right to make corrections, modifications, enhancements, improvements, and other changes to its products and services at any time and to discontinue any product or service without notice. Customers should obtain the latest relevant information before placing orders and should verify that such information is current and complete. All products are sold subject to TI's terms and conditions of sale supplied at the time of order acknowledgment.

TI warrants performance of its hardware products to the specifications applicable at the time of sale in accordance with TI's standard warranty. Testing and other quality control techniques are used to the extent TI deems necessary to support this warranty. Except where mandated by government requirements, testing of all parameters of each product is not necessarily performed.

TI assumes no liability for applications assistance or customer product design. Customers are responsible for their products and applications using TI components. To minimize the risks associated with customer products and applications, customers should provide adequate design and operating safeguards.

TI does not warrant or represent that any license, either express or implied, is granted under any TI patent right, copyright, mask work right, or other TI intellectual property right relating to any combination, machine, or process in which TI products or services are used. Information published by TI regarding third-party products or services does not constitute a license from TI to use such products or services or a warranty or endorsement thereof. Use of such information may require a license from a third party under the patents or other intellectual property of the third party, or a license from TI under the patents or other intellectual property of TI.

Reproduction of TI information in TI data books or data sheets is permissible only if reproduction is without alteration and is accompanied by all associated warranties, conditions, limitations, and notices. Reproduction of this information with alteration is an unfair and deceptive business practice. TI is not responsible or liable for such altered documentation. Information of third parties may be subject to additional restrictions.

Resale of TI products or services with statements different from or beyond the parameters stated by TI for that product or service voids all express and any implied warranties for the associated TI product or service and is an unfair and deceptive business practice. TI is not responsible or liable for any such statements.

TI products are not authorized for use in safety-critical applications (such as life support) where a failure of the TI product would reasonably be expected to cause severe personal injury or death, unless officers of the parties have executed an agreement specifically governing such use. Buyers represent that they have all necessary expertise in the safety and regulatory ramifications of their applications, and acknowledge and agree that they are solely responsible for all legal, regulatory and safety-related requirements concerning their products and any use of TI products in such safety-critical applications, notwithstanding any applications-related information or support that may be provided by TI. Further, Buyers must fully indemnify TI and its representatives against any damages arising out of the use of TI products in such safety-critical applications.

TI products are neither designed nor intended for use in military/aerospace applications or environments unless the TI products are specifically designated by TI as military-grade or "enhanced plastic." Only products designated by TI as military-grade meet military specifications. Buyers acknowledge and agree that any such use of TI products which TI has not designated as military-grade is solely at the Buyer's risk, and that they are solely responsible for compliance with all legal and regulatory requirements in connection with such use.

TI products are neither designed nor intended for use in automotive applications or environments unless the specific TI products are designated by TI as compliant with ISO/TS 16949 requirements. Buyers acknowledge and agree that, if they use any non-designated products in automotive applications, TI will not be responsible for any failure to meet such requirements.

Following are URLs where you can obtain information on other Texas Instruments products and application solutions:

### Products

Audio	<a href="http://www.ti.com/audio">www.ti.com/audio</a>
Amplifiers	<a href="http://amplifier.ti.com">amplifier.ti.com</a>
Data Converters	<a href="http://dataconverter.ti.com">dataconverter.ti.com</a>
DLP® Products	<a href="http://www.dlp.com">www.dlp.com</a>
DSP	<a href="http://dsp.ti.com">dsp.ti.com</a>
Clocks and Timers	<a href="http://www.ti.com/clocks">www.ti.com/clocks</a>
Interface	<a href="http://interface.ti.com">interface.ti.com</a>
Logic	<a href="http://logic.ti.com">logic.ti.com</a>
Power Mgmt	<a href="http://power.ti.com">power.ti.com</a>
Microcontrollers	<a href="http://microcontroller.ti.com">microcontroller.ti.com</a>
RFID	<a href="http://www.ti-rfid.com">www.ti-rfid.com</a>
RF/IF and ZigBee® Solutions	<a href="http://www.ti.com/lprf">www.ti.com/lprf</a>

### Applications

Communications and Telecom	<a href="http://www.ti.com/communications">www.ti.com/communications</a>
Computers and Peripherals	<a href="http://www.ti.com/computers">www.ti.com/computers</a>
Consumer Electronics	<a href="http://www.ti.com/consumer-apps">www.ti.com/consumer-apps</a>
Energy and Lighting	<a href="http://www.ti.com/energy">www.ti.com/energy</a>
Industrial	<a href="http://www.ti.com/industrial">www.ti.com/industrial</a>
Medical	<a href="http://www.ti.com/medical">www.ti.com/medical</a>
Security	<a href="http://www.ti.com/security">www.ti.com/security</a>
Space, Avionics and Defense	<a href="http://www.ti.com/space-avionics-defense">www.ti.com/space-avionics-defense</a>
Transportation and Automotive	<a href="http://www.ti.com/automotive">www.ti.com/automotive</a>
Video and Imaging	<a href="http://www.ti.com/video">www.ti.com/video</a>
Wireless	<a href="http://www.ti.com/wireless-apps">www.ti.com/wireless-apps</a>

TI E2E Community Home Page

[e2e.ti.com](http://e2e.ti.com)

Mailing Address: Texas Instruments, Post Office Box 655303, Dallas, Texas 75265  
Copyright © 2011, Texas Instruments Incorporated