

30V, N-Channel NexFET™ Power MOSFETs

 Check for Samples: [CSD17527Q5A](#)

FEATURES

- **Ultralow Q_g and Q_{gd}**
- **Low Thermal Resistance**
- **Avalanche Rated**
- **Pb Free Terminal Plating**
- **RoHS Compliant**
- **Halogen Free**
- **SON 5-mm × 6-mm Plastic Package**

APPLICATIONS

- **Point-of-Load Synchronous Buck in Networking, Telecom and Computing Systems**
- **Optimized for Control FET Applications**

DESCRIPTION

The NexFET™ power MOSFET has been designed to minimize losses in power conversion applications.

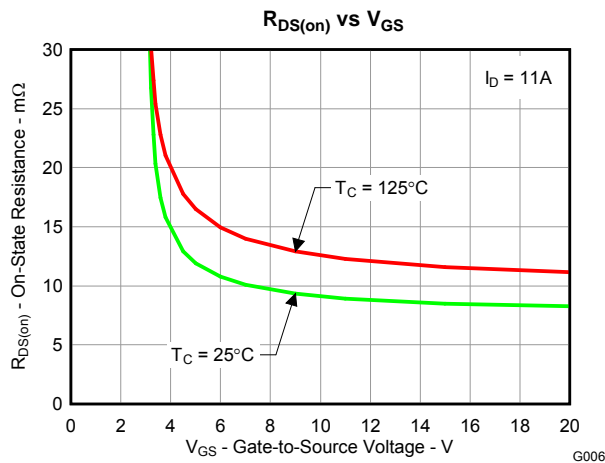
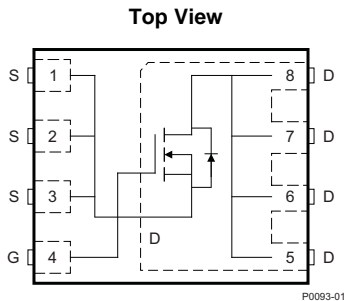

PRODUCT SUMMARY

V_{DS}	Drain to Source Voltage	30	V
Q_g	Gate Charge Total (4.5V)	2.8	nC
Q_{gd}	Gate Charge Gate to Drain	0.8	nC
$R_{DS(on)}$	Drain to Source On Resistance	$V_{GS} = 4.5V$	12.5 mΩ
		$V_{GS} = 10V$	9.3 mΩ
$V_{GS(th)}$	Threshold Voltage	1.6	V

ORDERING INFORMATION

Device	Package	Media	Qty	Ship
CSD17527Q5A	SON 5-mm × 6-mm Plastic Package	13-Inch Reel	2500	Tape and Reel

ABSOLUTE MAXIMUM RATINGS

$T_A = 25^\circ\text{C}$ unless otherwise stated		VALUE	UNIT
V_{DS}	Drain to Source Voltage	30	V
V_{GS}	Gate to Source Voltage	±20	V
I_D	Continuous Drain Current, $T_C = 25^\circ\text{C}$	65	A
	Continuous Drain Current ⁽¹⁾	13	A
I_{DM}	Pulsed Drain Current, $T_A = 25^\circ\text{C}$ ⁽²⁾	85	A
P_D	Power Dissipation ⁽¹⁾	3	W
T_J, T_{STG}	Operating Junction and Storage Temperature Range	-55 to 150	°C
E_{AS}	Avalanche Energy, single pulse $I_D = 30A, L = 0.1mH, R_G = 25\Omega$	45	mJ

(1) Typical $R_{\theta JA} = 44^\circ\text{C/W}$ on 1-inch² (6.45-cm²), 2-oz. (0.071-mm thick) Cu pad on a 0.06-inch (1.52-mm) thick FR4 PCB.

(2) Pulse duration $\leq 300\mu\text{s}$, duty cycle $\leq 2\%$

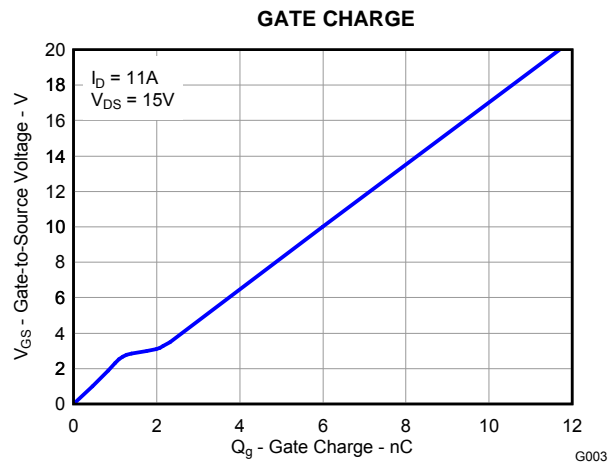

Please be aware that an important notice concerning availability, standard warranty, and use in critical applications of Texas Instruments semiconductor products and disclaimers thereto appears at the end of this data sheet.

NexFET is a trademark of Texas Instruments.

PRODUCTION DATA information is current as of publication date. Products conform to specifications per the terms of the Texas Instruments standard warranty. Production processing does not necessarily include testing of all parameters.



These devices have limited built-in ESD protection. The leads should be shorted together or the device placed in conductive foam during storage or handling to prevent electrostatic damage to the MOS gates.

ELECTRICAL CHARACTERISTICS

($T_A = 25^\circ\text{C}$ unless otherwise stated)

PARAMETER		TEST CONDITIONS	MIN	TYP	MAX	UNIT
Static Characteristics						
BV_{DSS}	Drain to Source Voltage	$V_{GS} = 0V, I_{DS} = 250\mu A$	30			V
I_{DSS}	Drain to Source Leakage Current	$V_{GS} = 0V, V_{DS} = 24V$			1	μA
I_{GSS}	Gate to Source Leakage Current	$V_{DS} = 0V, V_{GS} = \pm 20V$			100	nA
$V_{GS(th)}$	Gate to Source Threshold Voltage	$V_{DS} = V_{GS}, I_{DS} = 250\mu A$	1.1	1.6	2.0	V
$R_{DS(on)}$	Drain to Source On Resistance	$V_{GS} = 4.5V, I_{DS} = 11A$		12.5	15.5	m Ω
		$V_{GS} = 10V, I_{DS} = 11A$		9.3	10.8	m Ω
g_{fs}	Transconductance	$V_{DS} = 15V, I_{DS} = 11A$		44		S
Dynamic Characteristics						
C_{iss}	Input Capacitance	$V_{GS} = 0V, V_{DS} = 15V,$ $f = 1MHz$		422	506	pF
C_{oss}	Output Capacitance			286	343	pF
C_{riss}	Reverse Transfer Capacitance			26	33	pF
R_G	Series Gate Resistance	$V_{DS} = 15V, I_{DS} = 11A$		4.7		Ω
Q_g	Gate Charge Total (4.5V)			2.8	3.4	nC
Q_{gd}	Gate Charge Gate to Drain			0.8		nC
Q_{gs}	Gate Charge Gate to Source			1.2		nC
$Q_{g(th)}$	Gate Charge at V_{th}			0.6		nC
Q_{oss}	Output Charge	$V_{DS} = 13V, V_{GS} = 0V$		6.8		nC
$t_{d(on)}$	Turn On Delay Time	$V_{DS} = 15V, V_{GS} = 4.5V,$ $I_{DS} = 11A, R_G = 2\Omega$		5.6		ns
t_r	Rise Time			8.2		ns
$t_{d(off)}$	Turn Off Delay Time			9.8		ns
t_f	Fall Time			3.2		ns
Diode Characteristics						
V_{SD}	Diode Forward Voltage	$I_{SD} = 11A, V_{GS} = 0V$		0.85	1	V
Q_{rr}	Reverse Recovery Charge	$V_{DS} = 13V, I_F = 11A, di/dt = 300A/\mu s$		10.5		nC
t_{rr}	Reverse Recovery Time			14.6		ns

THERMAL CHARACTERISTICS

($T_A = 25^\circ\text{C}$ unless otherwise stated)

PARAMETER		MIN	TYP	MAX	UNIT
$R_{\theta JC}$	Thermal Resistance Junction to Case ⁽¹⁾			1.9	$^\circ\text{C/W}$
$R_{\theta JA}$	Thermal Resistance Junction to Ambient ⁽¹⁾⁽²⁾			51	$^\circ\text{C/W}$

- (1) $R_{\theta JC}$ is determined with the device mounted on a 1-inch² (6.45-cm²), 2-oz. (0.071-mm thick) Cu pad on a 1.5-inch × 1.5-inch (3.81-cm × 3.81-cm), 0.06-inch (1.52-mm) thick FR4 PCB. $R_{\theta JC}$ is specified by design, whereas $R_{\theta JA}$ is determined by the user's board design.
- (2) Device mounted on FR4 material with 1-inch² (6.45-cm²), 2-oz. (0.071-mm thick) Cu.

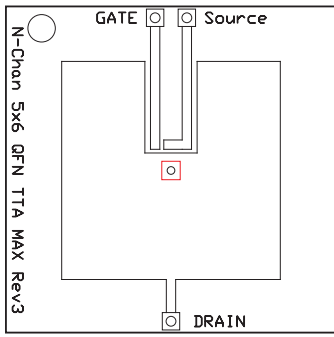

M0137-01

Max $R_{\theta JA} = 51^\circ\text{C/W}$
when mounted on
1 inch² (6.45 cm²) of
2-oz. (0.071-mm thick)
Cu.

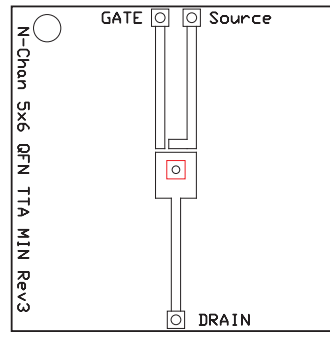

M0137-02

Max $R_{\theta JA} = 131^\circ\text{C/W}$
when mounted on a
minimum pad area of
2-oz. (0.071-mm thick)
Cu.

TYPICAL MOSFET CHARACTERISTICS

($T_A = 25^\circ\text{C}$ unless otherwise stated)

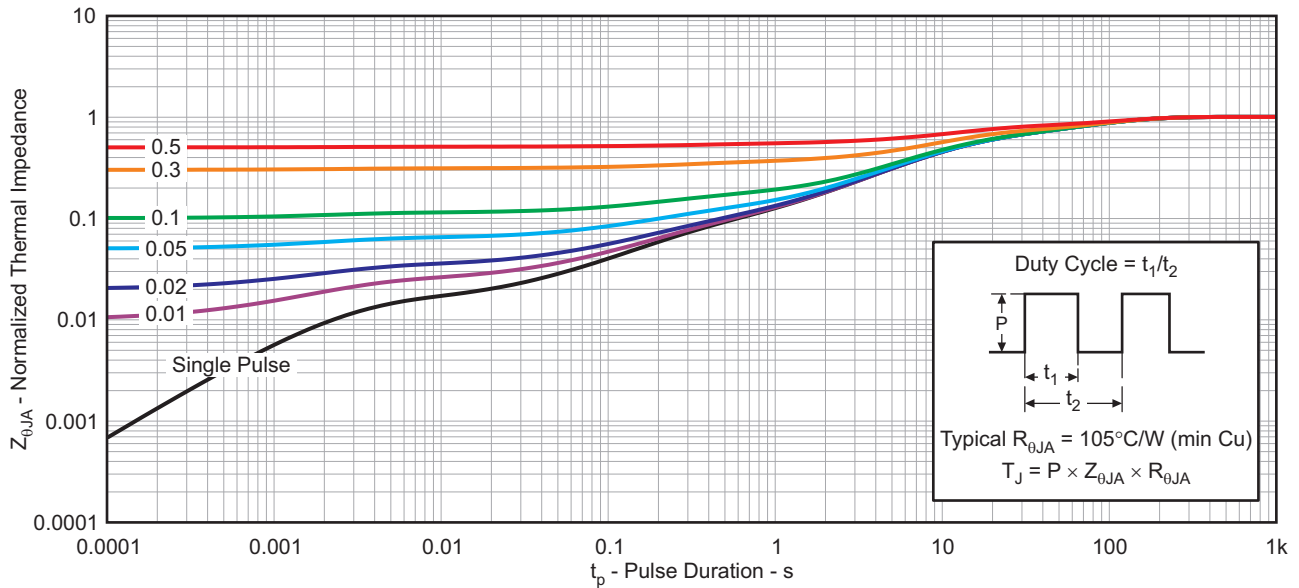

G012

Figure 1. Transient Thermal Impedance

TYPICAL MOSFET CHARACTERISTICS (continued)

($T_A = 25^\circ\text{C}$ unless otherwise stated)

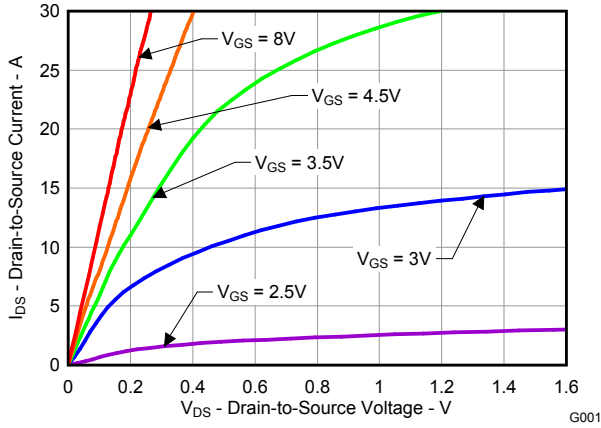

Figure 2. Saturation Characteristics

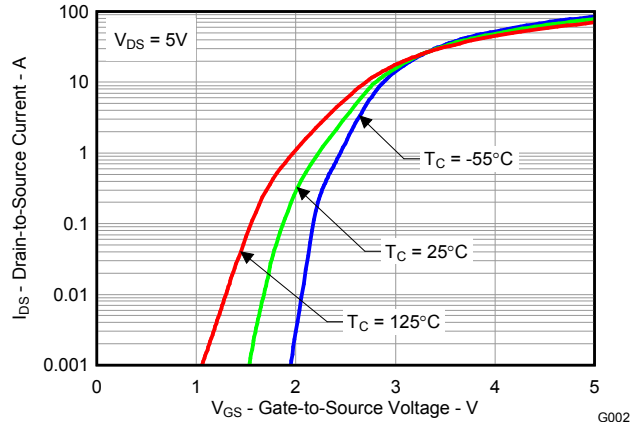

Figure 3. Transfer Characteristics

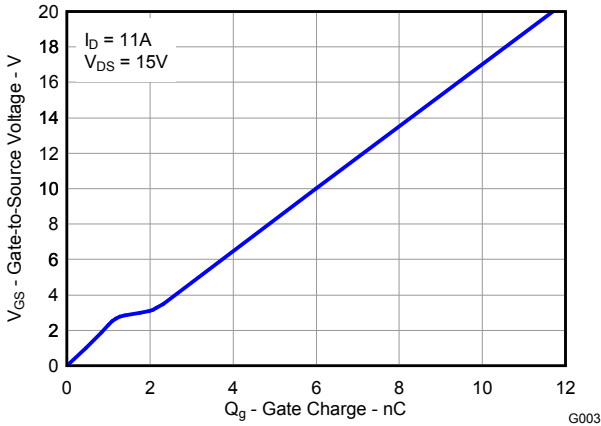

Figure 4. Gate Charge

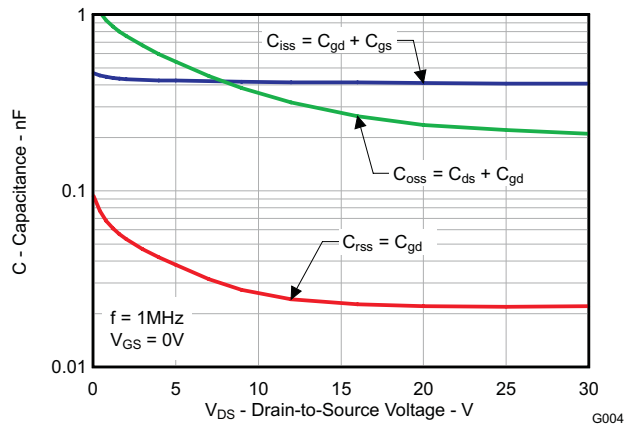

Figure 5. Capacitance

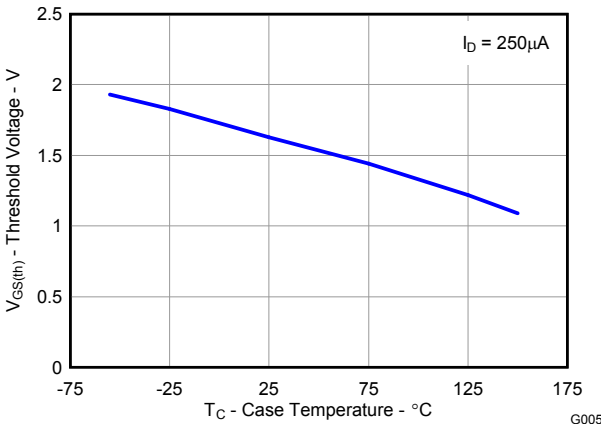

Figure 6. Threshold Voltage vs. Temperature

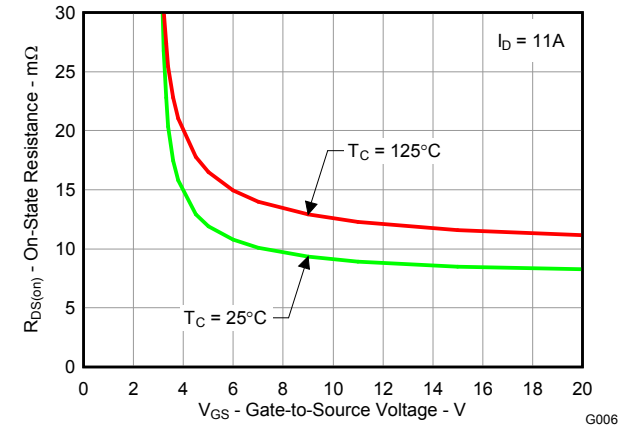

Figure 7. On-State Resistance vs. Gate-to-Source Voltage

TYPICAL MOSFET CHARACTERISTICS (continued)

($T_A = 25^\circ\text{C}$ unless otherwise stated)

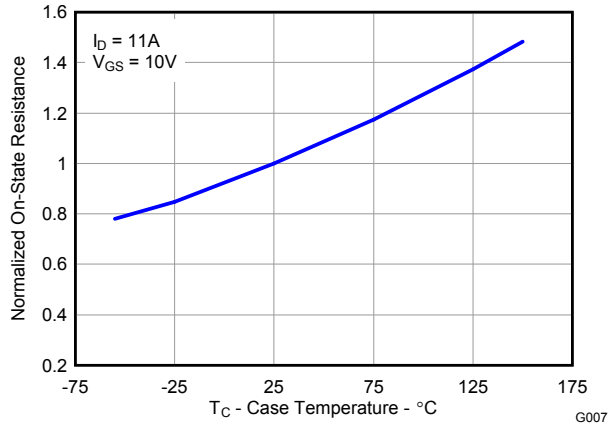

Figure 8. Normalized On-State Resistance vs. Temperature

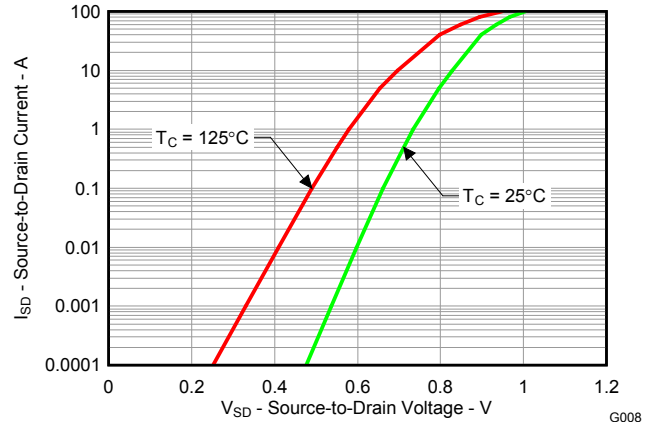

Figure 9. Typical Diode Forward Voltage

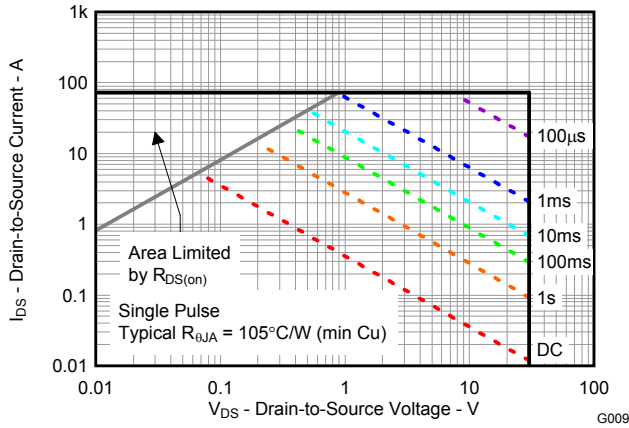

Figure 10. Maximum Safe Operating Area

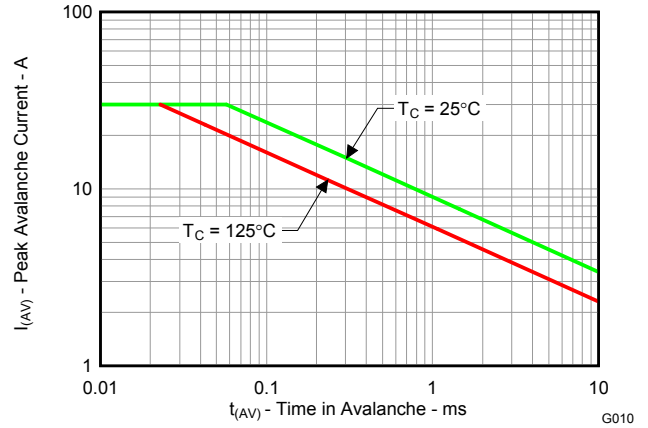

Figure 11. Single Pulse Unclamped Inductive Switching

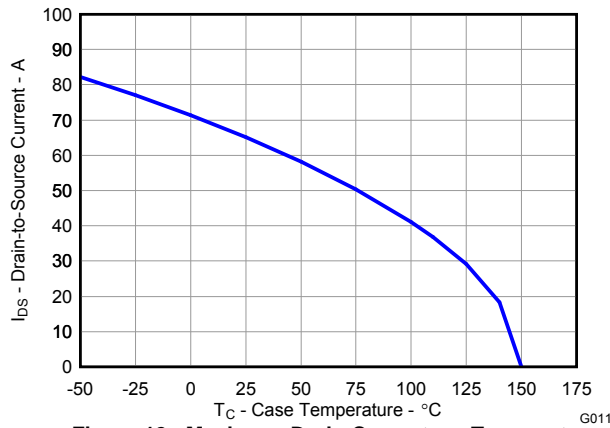
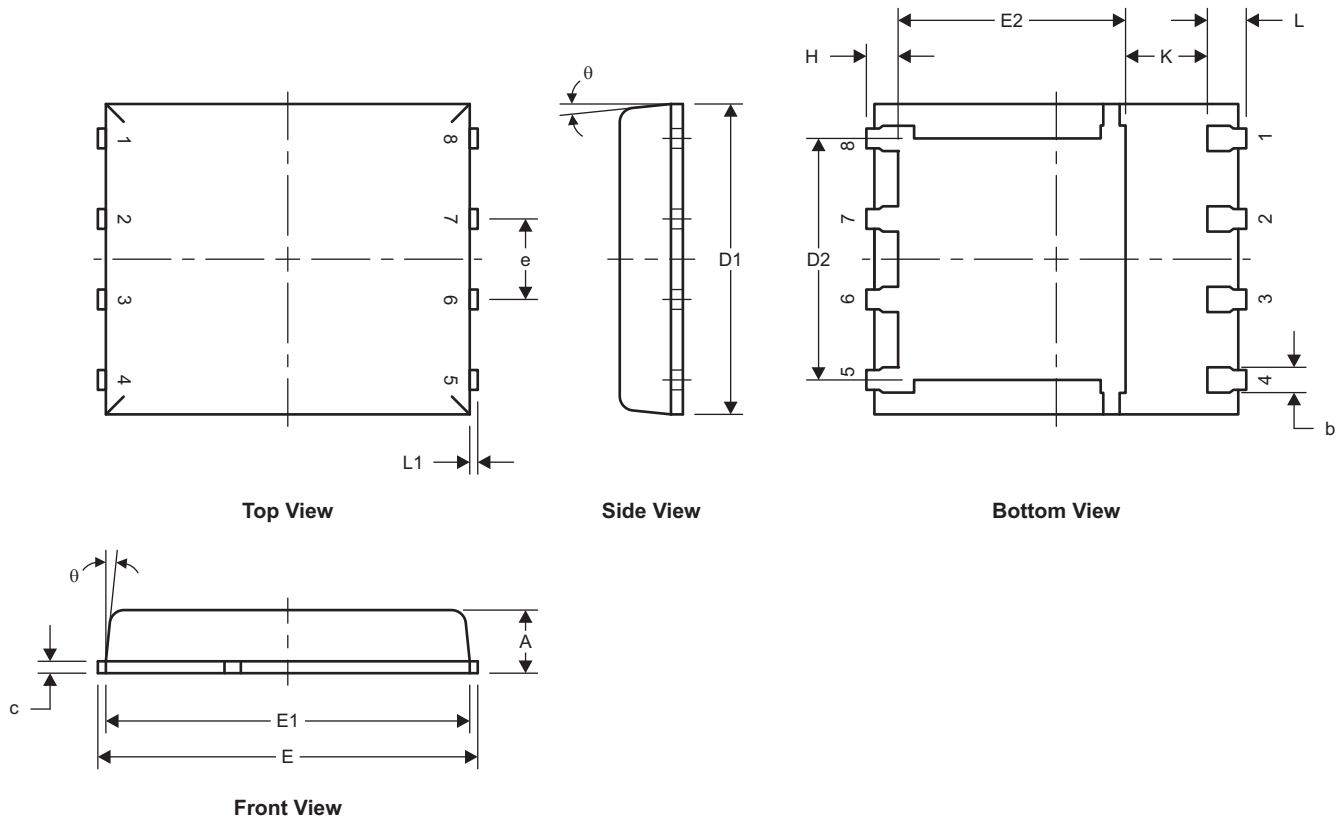

Figure 12. Maximum Drain Current vs. Temperature

MECHANICAL DATA

Q5A Package Dimensions



M0135-01

DIM	MILLIMETERS		
	MIN	NOM	MAX
A	0.90	1.00	1.10
b	0.33	0.41	0.51
c	0.20	0.25	0.34
D1	4.80	4.90	5.00
D2	3.61	3.81	4.02
E	5.90	6.00	6.10
E1	5.70	5.75	5.80
E2	3.38	3.58	3.78
e	1.17	1.27	1.37
H	0.41	0.56	0.71
K	1.10		
L	0.51	0.61	0.71
L1	0.06	0.13	0.20
θ	0°		12°

PACKAGING INFORMATION

Orderable Device	Status ⁽¹⁾	Package Type	Package Drawing	Pins	Package Qty	Eco Plan ⁽²⁾	Lead/ Ball Finish	MSL Peak Temp ⁽³⁾	Samples (Requires Login)
CSD17527Q5A	ACTIVE	SON	DQJ	8	2500	Pb-Free (RoHS Exempt)	CU SN	Level-1-260C-UNLIM	

⁽¹⁾ The marketing status values are defined as follows:

ACTIVE: Product device recommended for new designs.

LIFEBUY: TI has announced that the device will be discontinued, and a lifetime-buy period is in effect.

NRND: Not recommended for new designs. Device is in production to support existing customers, but TI does not recommend using this part in a new design.

PREVIEW: Device has been announced but is not in production. Samples may or may not be available.

OBSOLETE: TI has discontinued the production of the device.

⁽²⁾ Eco Plan - The planned eco-friendly classification: Pb-Free (RoHS), Pb-Free (RoHS Exempt), or Green (RoHS & no Sb/Br) - please check <http://www.ti.com/productcontent> for the latest availability information and additional product content details.

TBD: The Pb-Free/Green conversion plan has not been defined.

Pb-Free (RoHS): TI's terms "Lead-Free" or "Pb-Free" mean semiconductor products that are compatible with the current RoHS requirements for all 6 substances, including the requirement that lead not exceed 0.1% by weight in homogeneous materials. Where designed to be soldered at high temperatures, TI Pb-Free products are suitable for use in specified lead-free processes.

Pb-Free (RoHS Exempt): This component has a RoHS exemption for either 1) lead-based flip-chip solder bumps used between the die and package, or 2) lead-based die adhesive used between the die and leadframe. The component is otherwise considered Pb-Free (RoHS compatible) as defined above.

Green (RoHS & no Sb/Br): TI defines "Green" to mean Pb-Free (RoHS compatible), and free of Bromine (Br) and Antimony (Sb) based flame retardants (Br or Sb do not exceed 0.1% by weight in homogeneous material)

⁽³⁾ MSL, Peak Temp. -- The Moisture Sensitivity Level rating according to the JEDEC industry standard classifications, and peak solder temperature.

Important Information and Disclaimer: The information provided on this page represents TI's knowledge and belief as of the date that it is provided. TI bases its knowledge and belief on information provided by third parties, and makes no representation or warranty as to the accuracy of such information. Efforts are underway to better integrate information from third parties. TI has taken and continues to take reasonable steps to provide representative and accurate information but may not have conducted destructive testing or chemical analysis on incoming materials and chemicals. TI and TI suppliers consider certain information to be proprietary, and thus CAS numbers and other limited information may not be available for release.

In no event shall TI's liability arising out of such information exceed the total purchase price of the TI part(s) at issue in this document sold by TI to Customer on an annual basis.

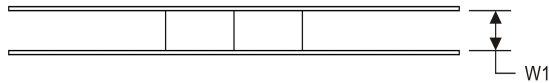
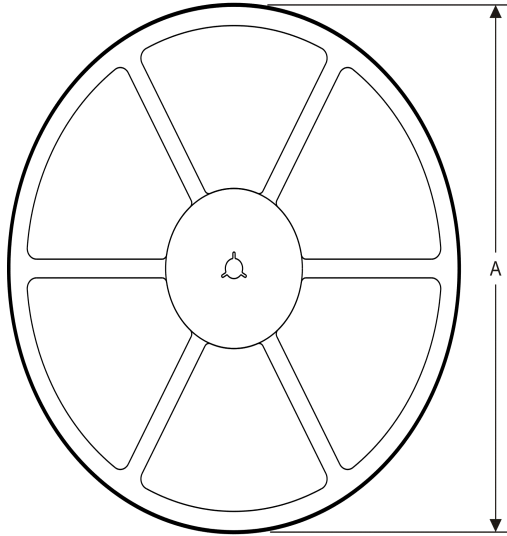
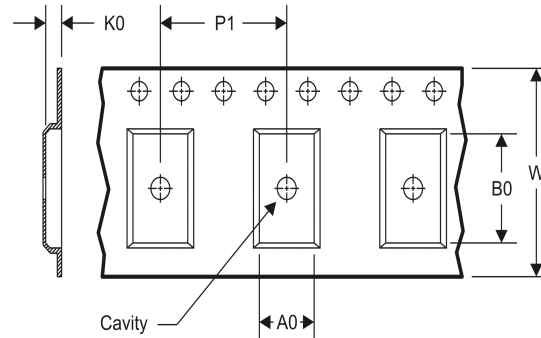
TAPE AND REEL INFORMATION
REEL DIMENSIONS

TAPE DIMENSIONS

A0	Dimension designed to accommodate the component width
B0	Dimension designed to accommodate the component length
K0	Dimension designed to accommodate the component thickness
W	Overall width of the carrier tape
P1	Pitch between successive cavity centers

TAPE AND REEL INFORMATION

*All dimensions are nominal

Device	Package Type	Package Drawing	Pins	SPQ	Reel Diameter (mm)	Reel Width W1 (mm)	A0 (mm)	B0 (mm)	K0 (mm)	P1 (mm)	W (mm)	Pin1 Quadrant
CSD17527Q5A	SON	DQJ	8	2500	330.0	12.4	6.3	5.3	1.2	8.0	12.0	Q1

TAPE AND REEL BOX DIMENSIONS

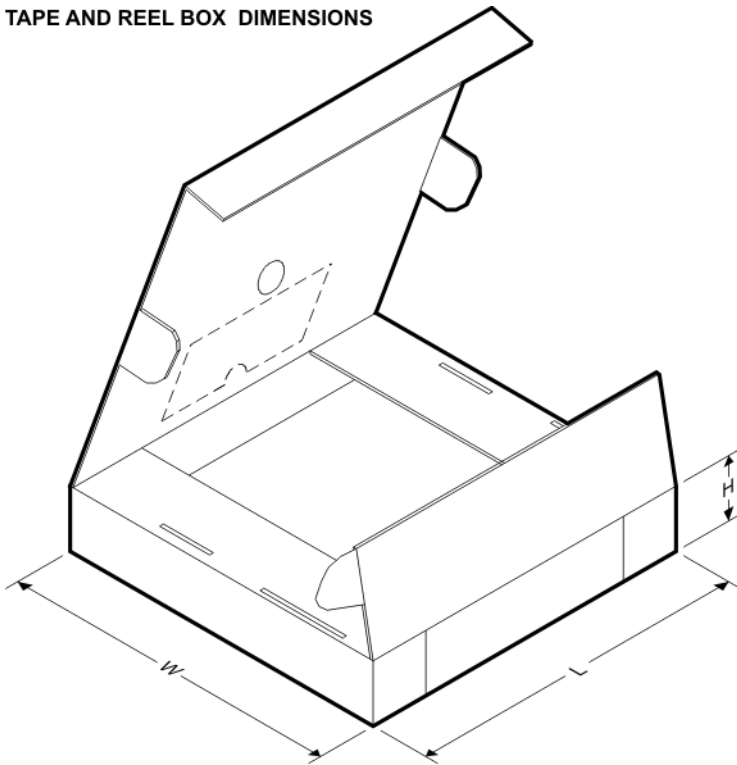

*All dimensions are nominal

Device	Package Type	Package Drawing	Pins	SPQ	Length (mm)	Width (mm)	Height (mm)
CSD17527Q5A	SON	DQJ	8	2500	340.0	340.0	38.0

IMPORTANT NOTICE

Texas Instruments Incorporated and its subsidiaries (TI) reserve the right to make corrections, modifications, enhancements, improvements, and other changes to its products and services at any time and to discontinue any product or service without notice. Customers should obtain the latest relevant information before placing orders and should verify that such information is current and complete. All products are sold subject to TI's terms and conditions of sale supplied at the time of order acknowledgment.

TI warrants performance of its hardware products to the specifications applicable at the time of sale in accordance with TI's standard warranty. Testing and other quality control techniques are used to the extent TI deems necessary to support this warranty. Except where mandated by government requirements, testing of all parameters of each product is not necessarily performed.

TI assumes no liability for applications assistance or customer product design. Customers are responsible for their products and applications using TI components. To minimize the risks associated with customer products and applications, customers should provide adequate design and operating safeguards.

TI does not warrant or represent that any license, either express or implied, is granted under any TI patent right, copyright, mask work right, or other TI intellectual property right relating to any combination, machine, or process in which TI products or services are used. Information published by TI regarding third-party products or services does not constitute a license from TI to use such products or services or a warranty or endorsement thereof. Use of such information may require a license from a third party under the patents or other intellectual property of the third party, or a license from TI under the patents or other intellectual property of TI.

Reproduction of TI information in TI data books or data sheets is permissible only if reproduction is without alteration and is accompanied by all associated warranties, conditions, limitations, and notices. Reproduction of this information with alteration is an unfair and deceptive business practice. TI is not responsible or liable for such altered documentation. Information of third parties may be subject to additional restrictions.

Resale of TI products or services with statements different from or beyond the parameters stated by TI for that product or service voids all express and any implied warranties for the associated TI product or service and is an unfair and deceptive business practice. TI is not responsible or liable for any such statements.

TI products are not authorized for use in safety-critical applications (such as life support) where a failure of the TI product would reasonably be expected to cause severe personal injury or death, unless officers of the parties have executed an agreement specifically governing such use. Buyers represent that they have all necessary expertise in the safety and regulatory ramifications of their applications, and acknowledge and agree that they are solely responsible for all legal, regulatory and safety-related requirements concerning their products and any use of TI products in such safety-critical applications, notwithstanding any applications-related information or support that may be provided by TI. Further, Buyers must fully indemnify TI and its representatives against any damages arising out of the use of TI products in such safety-critical applications.

TI products are neither designed nor intended for use in military/aerospace applications or environments unless the TI products are specifically designated by TI as military-grade or "enhanced plastic." Only products designated by TI as military-grade meet military specifications. Buyers acknowledge and agree that any such use of TI products which TI has not designated as military-grade is solely at the Buyer's risk, and that they are solely responsible for compliance with all legal and regulatory requirements in connection with such use.

TI products are neither designed nor intended for use in automotive applications or environments unless the specific TI products are designated by TI as compliant with ISO/TS 16949 requirements. Buyers acknowledge and agree that, if they use any non-designated products in automotive applications, TI will not be responsible for any failure to meet such requirements.

Following are URLs where you can obtain information on other Texas Instruments products and application solutions:

Products

Audio	www.ti.com/audio
Amplifiers	amplifier.ti.com
Data Converters	dataconverter.ti.com
DLP® Products	www.dlp.com
DSP	dsp.ti.com
Clocks and Timers	www.ti.com/clocks
Interface	interface.ti.com
Logic	logic.ti.com
Power Mgmt	power.ti.com
Microcontrollers	microcontroller.ti.com
RFID	www.ti-rfid.com
OMAP Mobile Processors	www.ti.com/omap
Wireless Connectivity	www.ti.com/wirelessconnectivity

Applications

Communications and Telecom	www.ti.com/communications
Computers and Peripherals	www.ti.com/computers
Consumer Electronics	www.ti.com/consumer-apps
Energy and Lighting	www.ti.com/energy
Industrial	www.ti.com/industrial
Medical	www.ti.com/medical
Security	www.ti.com/security
Space, Avionics and Defense	www.ti.com/space-avionics-defense
Transportation and Automotive	www.ti.com/automotive
Video and Imaging	www.ti.com/video

TI E2E Community Home Page

e2e.ti.com

Mailing Address: Texas Instruments, Post Office Box 655303, Dallas, Texas 75265
Copyright © 2011, Texas Instruments Incorporated