

# FDMC7208S

## Dual N-Channel PowerTrench® MOSFET

Q1: 30 V, 12 A, 9.0 mΩ Q2: 30 V, 16 A, 6.4 mΩ

### Features

Q1: N-Channel

- Max  $r_{DS(on)}$  = 9.0 mΩ at  $V_{GS} = 10\text{ V}$ ,  $I_D = 12\text{ A}$
- Max  $r_{DS(on)}$  = 11.0 mΩ at  $V_{GS} = 4.5\text{ V}$ ,  $I_D = 11\text{ A}$

Q2: N-Channel

- Max  $r_{DS(on)}$  = 6.4 mΩ at  $V_{GS} = 10\text{ V}$ ,  $I_D = 16\text{ A}$
- Max  $r_{DS(on)}$  = 7.5 mΩ at  $V_{GS} = 4.5\text{ V}$ ,  $I_D = 13.5\text{ A}$
- Termination is Lead-free and RoHS Compliant

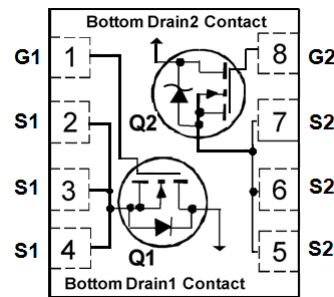
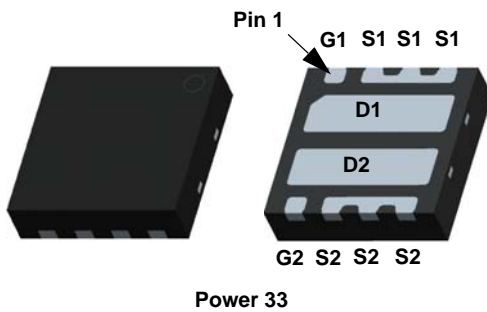


### General Description

This device includes two 30V N-Channel MOSFETs in a dual Power 33 (3 mm X 3 mm MLP) package. The package is enhanced for exceptional thermal performance.

### Applications

- Computing
- Communications
- General Purpose Point of Load
- Notebook System



### MOSFET Maximum Ratings $T_A = 25^\circ\text{C}$ unless otherwise noted

Symbol	Parameter	Q1	Q2	Units
$V_{DS}$	Drain to Source Voltage	30	30	V
$V_{GS}$	Gate to Source Voltage (Note 4)	$\pm 20$	$\pm 12$	V
$I_D$	Drain Current -Continuous (Package limited) $T_C = 25^\circ\text{C}$	22	26	A
	-Continuous $T_A = 25^\circ\text{C}$	12 <sup>1a</sup>	16 <sup>1b</sup>	
	-Pulsed	60	80	
$E_{AS}$	Single Pulse Avalanche Energy (Note 3)	21	21	mJ
$P_D$	Power Dissipation for Single Operation $T_A = 25^\circ\text{C}$	1.9 <sup>1a</sup>	1.9 <sup>1b</sup>	W
	Power Dissipation for Single Operation $T_A = 25^\circ\text{C}$	0.8 <sup>1c</sup>	0.8 <sup>1d</sup>	
$T_J, T_{STG}$	Operating and Storage Junction Temperature Range	-55 to +150		$^\circ\text{C}$

### Thermal Characteristics

$R_{\theta JA}$	Thermal Resistance, Junction to Ambient	65 <sup>1a</sup>	65 <sup>1b</sup>	$^\circ\text{C/W}$
$R_{\theta JA}$	Thermal Resistance, Junction to Ambient	155 <sup>1c</sup>	155 <sup>1d</sup>	

### Package Marking and Ordering Information

Device Marking	Device	Package	Reel Size	Tape Width	Quantity
FDMC7208S	FDMC7208S	Power 33	13"	12 mm	3000 units

**Electrical Characteristics**  $T_J = 25\text{ }^\circ\text{C}$  unless otherwise noted

Symbol	Parameter	Test Conditions	Type	Min	Typ	Max	Units
--------	-----------	-----------------	------	-----	-----	-----	-------

**Off Characteristics**

$BV_{DSS}$	Drain to Source Breakdown Voltage	$I_D = 250\text{ }\mu\text{A}$ , $V_{GS} = 0\text{ V}$ $I_D = 1\text{ mA}$ , $V_{GS} = 0\text{ V}$	Q1 Q2	30 30			V
$\frac{\Delta BV_{DSS}}{\Delta T_J}$	Breakdown Voltage Temperature Coefficient	$I_D = 250\text{ }\mu\text{A}$ , referenced to $25\text{ }^\circ\text{C}$ $I_D = 10\text{ mA}$ , referenced to $25\text{ }^\circ\text{C}$	Q1 Q2		27 21		mV/ $^\circ\text{C}$
$I_{DSS}$	Zero Gate Voltage Drain Current	$V_{DS} = 24\text{ V}$ , $V_{GS} = 0\text{ V}$	Q1 Q2			1 500	$\mu\text{A}$
$I_{GSS}$	Gate to Source Leakage Current, Forward	$V_{GS} = 20\text{ V}$ , $V_{DS} = 0\text{ V}$ $V_{GS} = 12\text{ V}$ , $V_{DS} = 0\text{ V}$	Q1 Q2			100 100	nA

**On Characteristics**

$V_{GS(th)}$	Gate to Source Threshold Voltage	$I_D = 250\text{ }\mu\text{A}$ , $V_{GS} = 0\text{ V}$ $I_D = 1\text{ mA}$ , $V_{GS} = 0\text{ V}$	Q1 Q2	1.2 1.2	1.7 1.6	3.0 3.0	V
$\frac{\Delta V_{GS(th)}}{\Delta T_J}$	Gate to Source Threshold Voltage Temperature Coefficient	$I_D = 250\text{ }\mu\text{A}$ , referenced to $25\text{ }^\circ\text{C}$ $I_D = 10\text{ mA}$ , referenced to $25\text{ }^\circ\text{C}$	Q1 Q2		-5 -3		mV/ $^\circ\text{C}$
$r_{DS(on)}$	Drain to Source On Resistance	$V_{GS} = 10\text{ V}$ , $I_D = 12\text{ A}$ $V_{GS} = 4.5\text{ V}$ , $I_D = 11\text{ A}$ $V_{GS} = 10\text{ V}$ , $I_D = 12\text{ A}$ , $T_J = 125\text{ }^\circ\text{C}$	Q1		6.7 8.8 9.2	9.0 11.0 12.4	m $\Omega$
		$V_{GS} = 10\text{ V}$ , $I_D = 16\text{ A}$ $V_{GS} = 4.5\text{ V}$ , $I_D = 13.5\text{ A}$ $V_{GS} = 10\text{ V}$ , $I_D = 16\text{ A}$ , $T_J = 125\text{ }^\circ\text{C}$	Q2		4.7 5.3 6.4	6.4 7.5 6.8	
$g_{FS}$	Forward Transconductance	$V_{DS} = 5\text{ V}$ , $I_D = 12\text{ A}$ $V_{DS} = 5\text{ V}$ , $I_D = 16\text{ A}$	Q1 Q2		53 80		S

**Dynamic Characteristics**

$C_{iss}$	Input Capacitance	Q1: $V_{DS} = 15\text{ V}$ , $V_{GS} = 0\text{ V}$ , $f = 1\text{ MHz}$	Q1 Q2		848 1685	1130 2245	pF
$C_{oss}$	Output Capacitance	Q2: $V_{DS} = 15\text{ V}$ , $V_{GS} = 0\text{ V}$ , $f = 1\text{ MHz}$	Q1 Q2		270 432	360 575	pF
$C_{riss}$	Reverse Transfer Capacitance	$V_{DS} = 15\text{ V}$ , $V_{GS} = 0\text{ V}$ , $f = 1\text{ MHz}$	Q1 Q2		36 42	55 65	pF
$R_g$	Gate Resistance		Q1 Q2	0.1 0.1	1.1 1.0	2.5 2.5	$\Omega$

**Switching Characteristics**

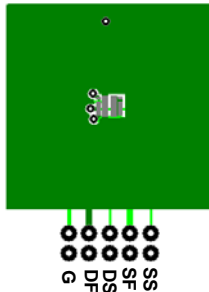
$t_{d(on)}$	Turn-On Delay Time	Q1: $V_{DD} = 15\text{ V}$ , $I_D = 12\text{ A}$ , $R_{GEN} = 6\text{ }\Omega$ Q2: $V_{DD} = 15\text{ V}$ , $I_D = 16\text{ A}$ , $R_{GEN} = 6\text{ }\Omega$	Q1 Q2		6 7	12 14	ns	
$t_r$	Rise Time		Q1 Q2		2 3	10 10	ns	
$t_{d(off)}$	Turn-Off Delay Time		Q1 Q2		16 23	29 36	ns	
$t_f$	Fall Time		Q1 Q2		2 2	10 10	ns	
$Q_g$	Total Gate Charge	$V_{GS} = 0\text{ V}$ to $10\text{ V}$	Q1 $V_{DD} = 15\text{ V}$ , $I_D = 12\text{ A}$	Q1 Q2		13 26	18 36	nC
				Q1 Q2		6.7 14	9.4 20	nC
$Q_{gs}$	Gate to Source Gate Charge	Q2 $V_{DD} = 15\text{ V}$ , $I_D = 16\text{ A}$	Q1 Q2		2.3 3.9		nC	
$Q_{gd}$	Gate to Drain "Miller" Charge		Q1 Q2		1.8 2.7		nC	

### Electrical Characteristics $T_J = 25\text{ }^\circ\text{C}$ unless otherwise noted

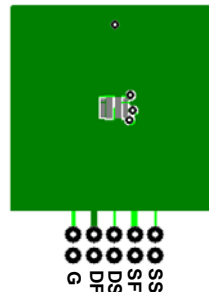
Symbol	Parameter	Test Conditions	Type	Min	Typ	Max	Units
<b>Drain-Source Diode Characteristics</b>							
$V_{SD}$	Source to Drain Diode Forward Voltage	$V_{GS} = 0\text{ V}, I_S = 2\text{ A}$ (Note 2)	Q1		0.72	1.2	V
		$V_{GS} = 0\text{ V}, I_S = 12\text{ A}$ (Note 2)	Q1		0.82	1.2	
		$V_{GS} = 0\text{ V}, I_S = 2\text{ A}$ (Note 2)	Q2		0.70	1.2	
		$V_{GS} = 0\text{ V}, I_S = 16\text{ A}$ (Note 2)	Q2		0.82	1.2	
$t_{rr}$	Reverse Recovery Time	Q1 $I_F = 12\text{ A}, di/dt = 100\text{ A}/\mu\text{s}$	Q1		21	34	ns
			Q2		21	33	
$Q_{rr}$	Reverse Recovery Charge	Q2 $I_F = 16\text{ A}, di/dt = 300\text{ A}/\mu\text{s}$	Q1		6	12	nC
			Q2		16	28	

**Notes:**

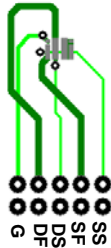
1.  $R_{\theta JA}$  is determined with the device mounted on a 1 in<sup>2</sup> pad 2 oz copper pad on a 1.5 x 1.5 in. board of FR-4 material.  $R_{\theta JC}$  is guaranteed by design while  $R_{\theta CA}$  is determined by the user's board design.



a. 65 °C/W when mounted on a 1 in<sup>2</sup> pad of 2 oz copper



b. 65 °C/W when mounted on a 1 in<sup>2</sup> pad of 2 oz copper



c. 155 °C/W when mounted on a minimum pad of 2 oz copper



d. 155 °C/W when mounted on a minimum pad of 2 oz copper

2. Pulse Test: Pulse Width < 300  $\mu\text{s}$ , Duty cycle < 2.0%.

3. Q1:  $E_{AS}$  of 21 mJ is based on starting  $T_J = 25\text{ }^\circ\text{C}$ ,  $L = 0.3\text{ mH}$ ,  $I_{AS} = 12\text{ A}$ ,  $V_{DD} = 27\text{ V}$ ,  $V_{GS} = 10\text{ V}$ . 100% tested at  $L = 3\text{ mH}$ ,  $I_{AS} = 5.2\text{ A}$ .

Q1:  $E_{AS}$  of 21 mJ is based on starting  $T_J = 25\text{ }^\circ\text{C}$ ,  $L = 0.3\text{ mH}$ ,  $I_{AS} = 12\text{ A}$ ,  $V_{DD} = 27\text{ V}$ ,  $V_{GS} = 10\text{ V}$ . 100% tested at  $L = 3\text{ mH}$ ,  $I_{AS} = 5.4\text{ A}$ .

4. As an N-ch device, the negative Vgs rating is for low duty cycle pulse occurrence only. No continuous rating is implied

**Typical Characteristics (Q1 N-Channel)**  $T_J = 25^\circ\text{C}$  unless otherwise noted

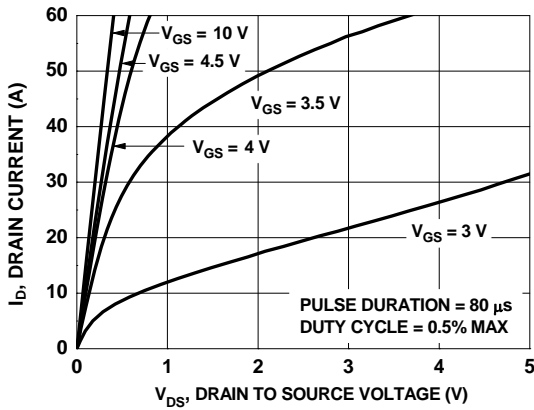


Figure 1. On Region Characteristics

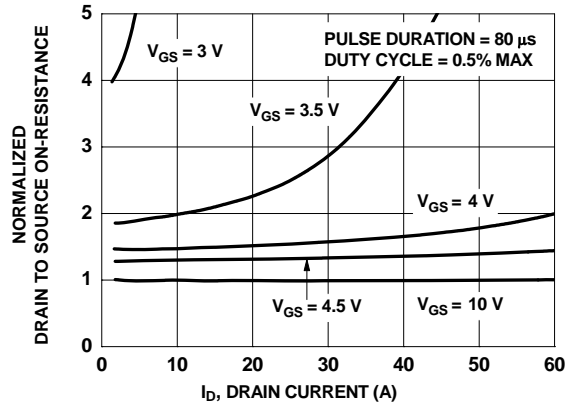


Figure 2. Normalized On-Resistance vs Drain Current and Gate Voltage

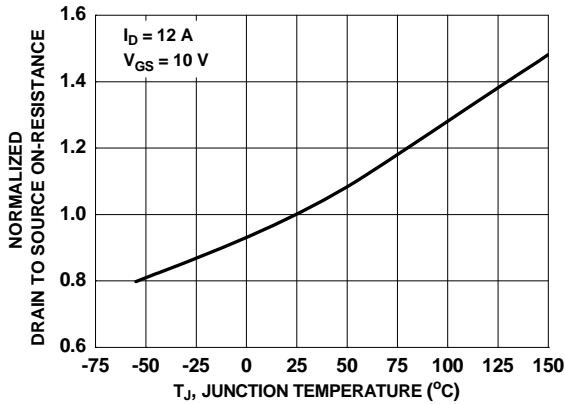


Figure 3. Normalized On Resistance vs Junction Temperature

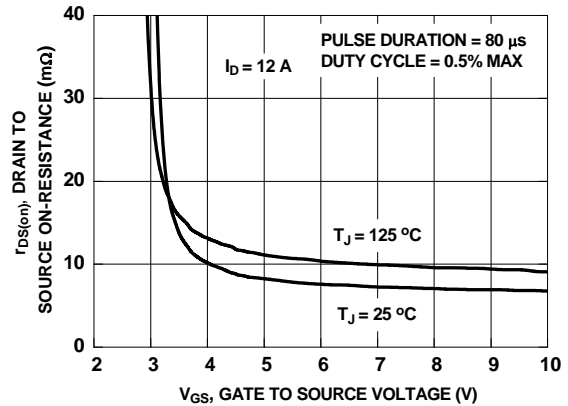


Figure 4. On-Resistance vs Gate to Source Voltage

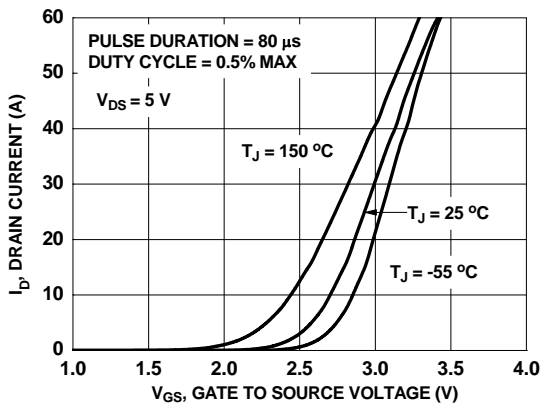


Figure 5. Transfer Characteristics

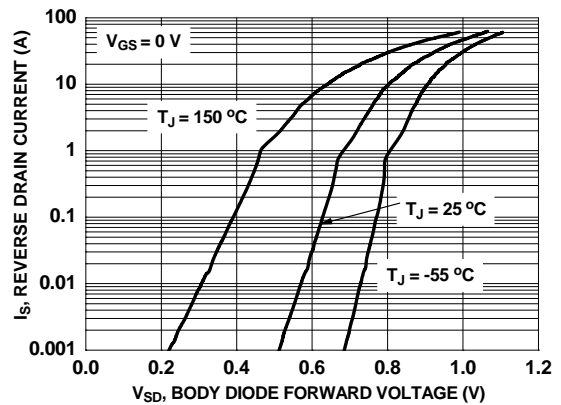
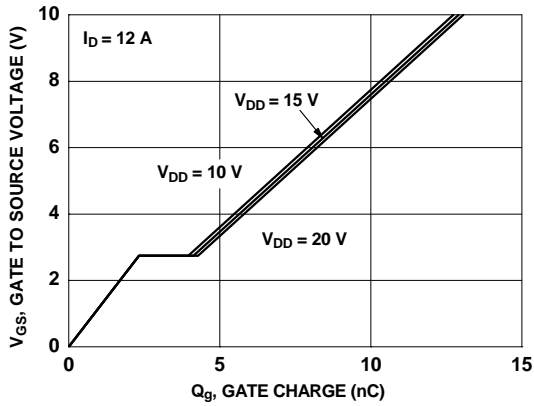
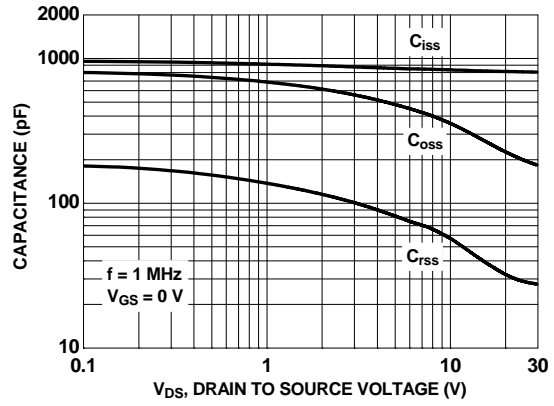


Figure 6. Source to Drain Diode Forward Voltage vs Source Current

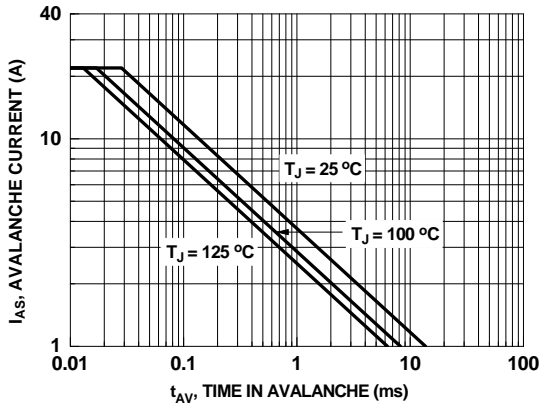
**Typical Characteristics (Q1 N-Channel)**  $T_J = 25^\circ\text{C}$  unless otherwise noted



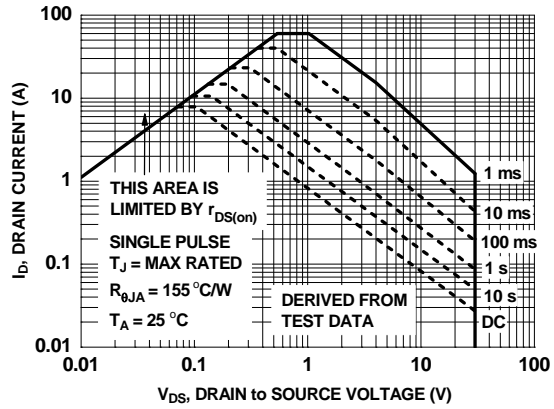
**Figure 7. Gate Charge Characteristics**



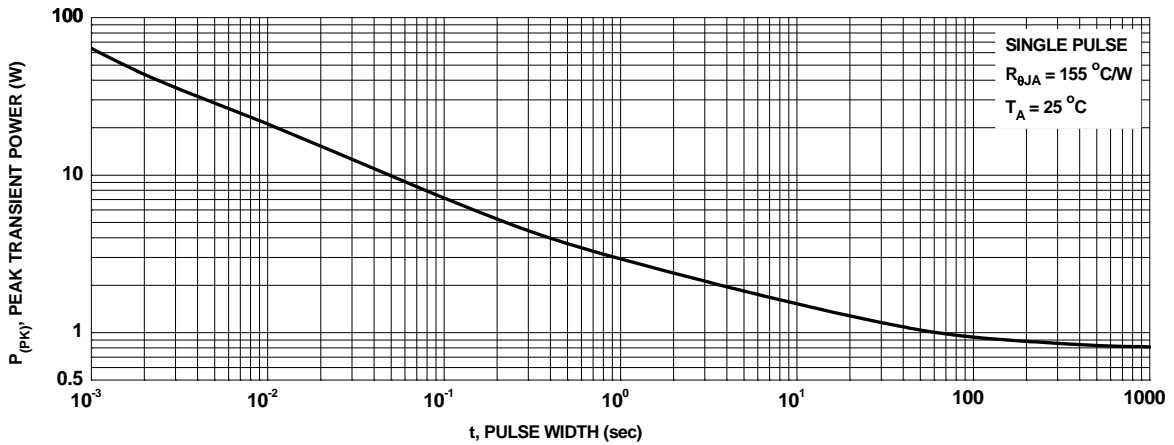
**Figure 8. Capacitance vs Drain to Source Voltage**



**Figure 9. Unclamped Inductive Switching Capability**

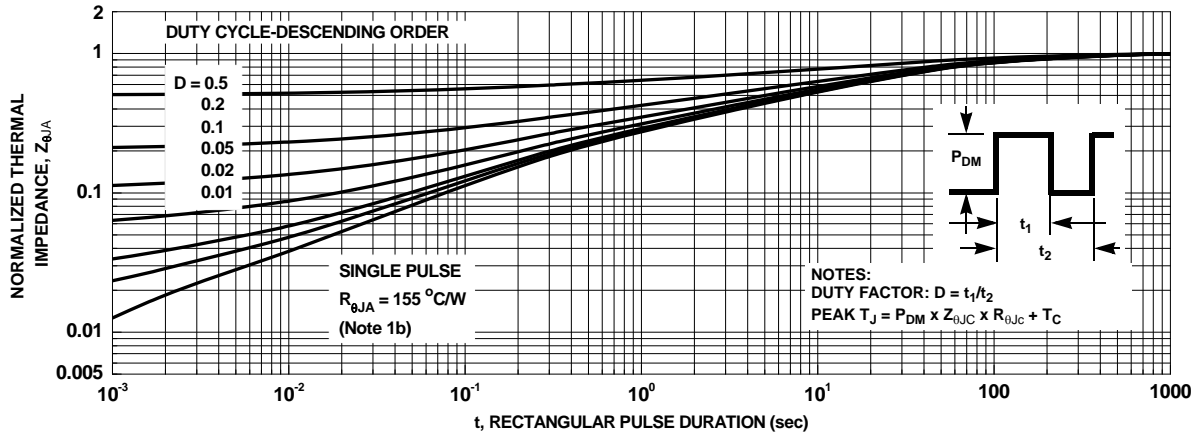


**Figure 10. Forward Bias Safe Operating Area**



**Figure 11. Single Pulse Maximum Power Dissipation**

**Typical Characteristics (Q1 N-Channel)**  $T_J = 25^\circ\text{C}$  unless otherwise noted



**Figure 12. Junction-to-Ambient Transient Thermal Response Curve**

**Typical Characteristics (Q2 N-Channel)**  $T_J = 25\text{ }^\circ\text{C}$  unless otherwise noted

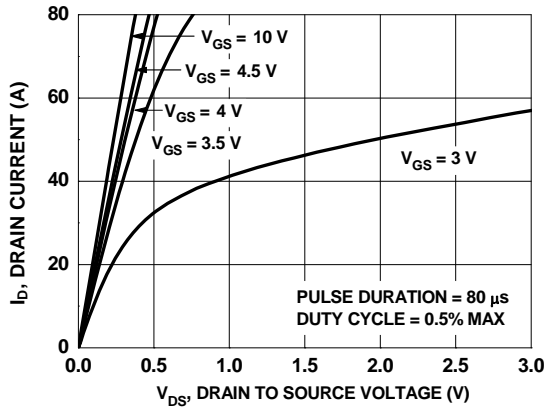


Figure 14. On-Region Characteristics

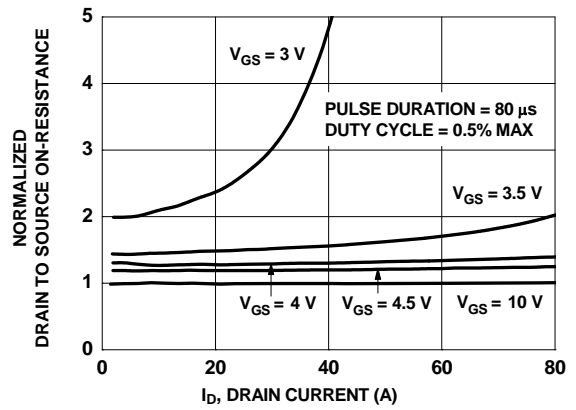


Figure 15. Normalized on-Resistance vs Drain Current and Gate Voltage

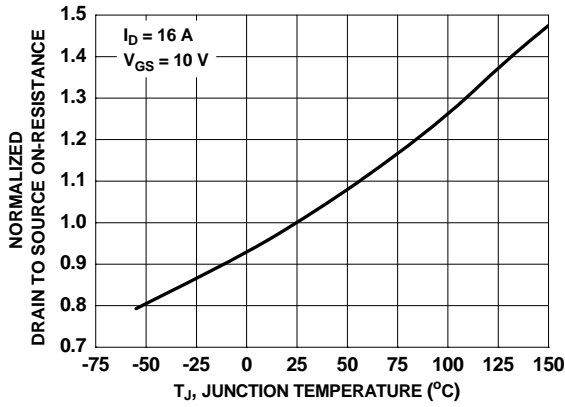


Figure 16. Normalized On-Resistance vs Junction Temperature

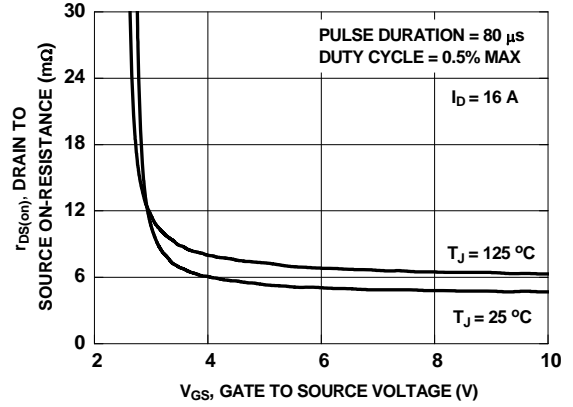


Figure 17. On-Resistance vs Gate to Source Voltage

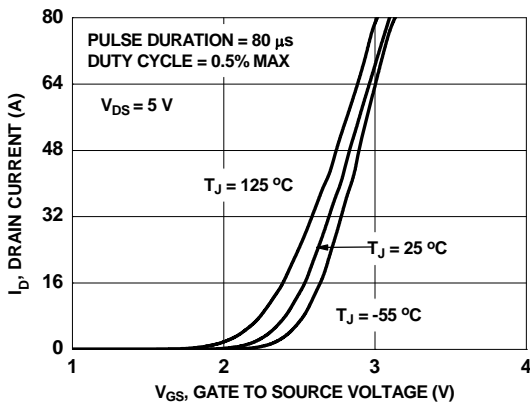


Figure 18. Transfer Characteristics

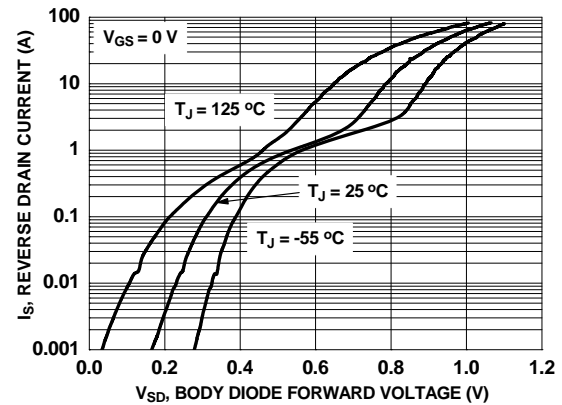
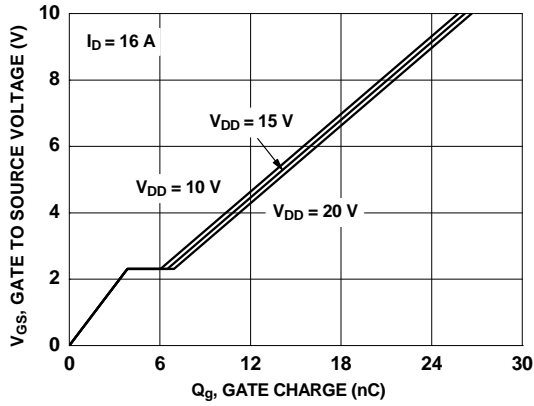
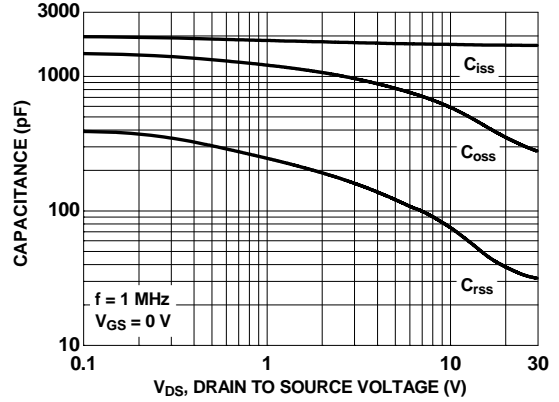


Figure 19. Source to Drain Diode Forward Voltage vs Source Current

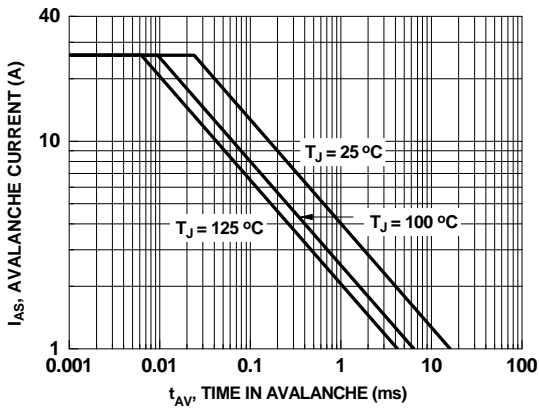
**Typical Characteristics (Q2 N-Channel)**  $T_J = 25^\circ\text{C}$  unless otherwise noted



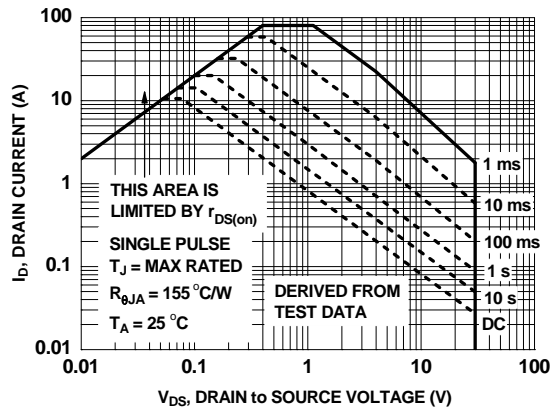
**Figure 20. Gate Charge Characteristics**



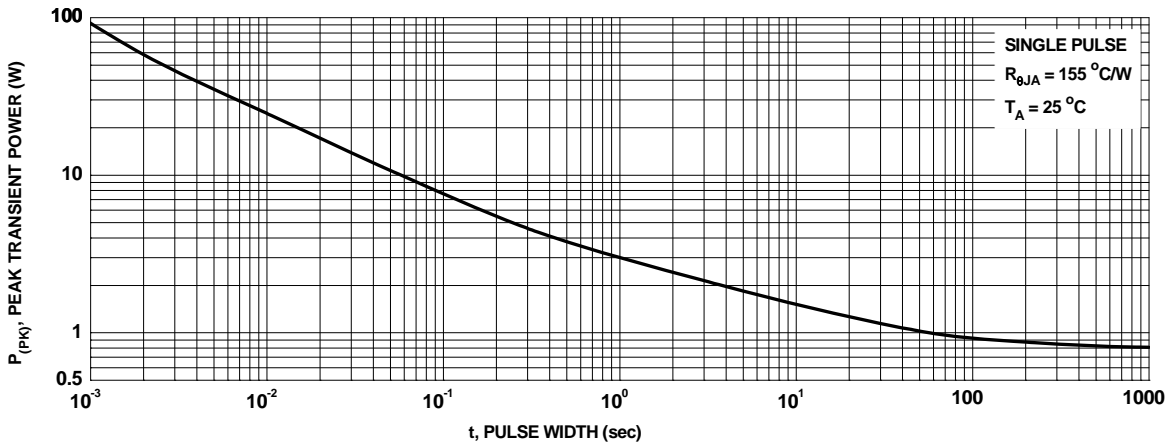
**Figure 21. Capacitance vs Drain to Source Voltage**



**Figure 22. Unclamped Inductive Switching Capability**



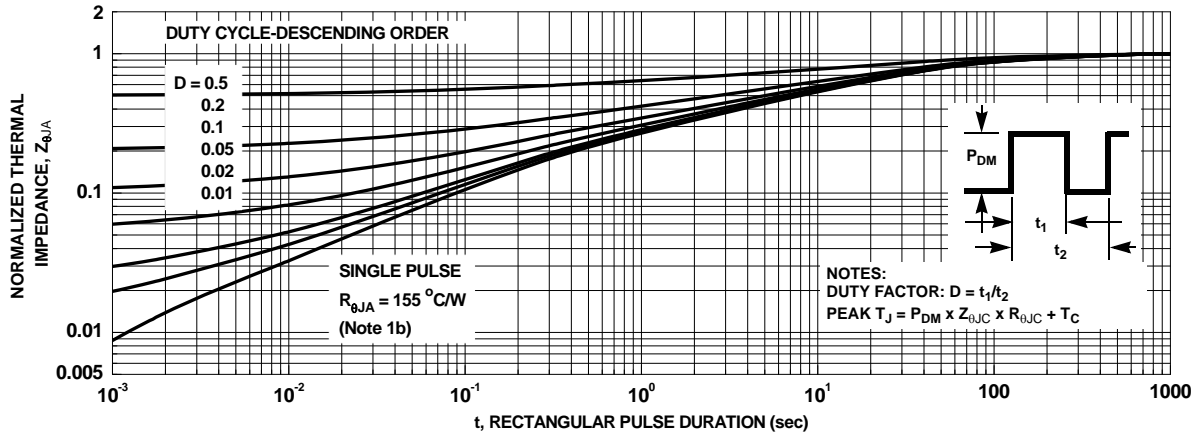
**Figure 23. Forward Bias Safe Operating Area**



**Figure 24. Single Pulse Maximum Power Dissipation**



**Typical Characteristics (Q2 N-Channel)**  $T_J = 25\text{ }^\circ\text{C}$  unless otherwise noted



**Figure 26. Junction-to-Ambient Transient Thermal Response Curve**

## Typical Characteristics (continued)

### SyncFET<sup>™</sup> Schottky body diode Characteristics

Fairchild's SyncFET<sup>™</sup> process embeds a Schottky diode in parallel with PowerTrench MOSFET. This diode exhibits similar characteristics to a discrete external Schottky diode in parallel with a MOSFET. Figure 27 shows the reverse recovery characteristic of the FDMC7208S.

Schottky barrier diodes exhibit significant leakage at high temperature and high reverse voltage. This will increase the power in the device.

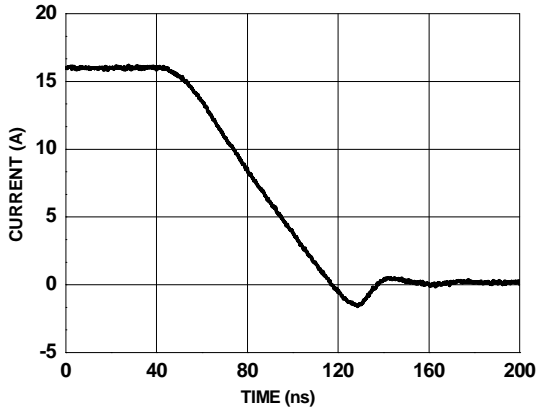


Figure 27. FDMC7208S SyncFET<sup>™</sup> body diode reverse recovery characteristic

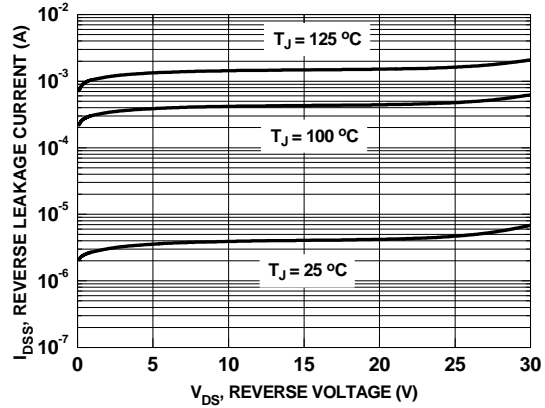
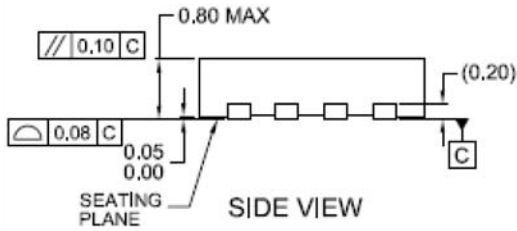
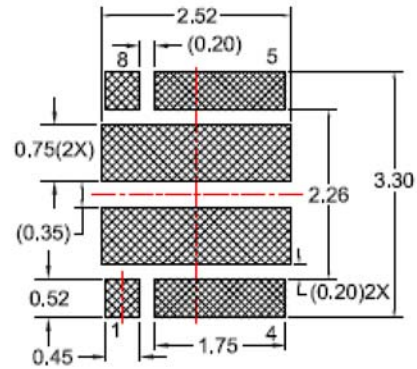
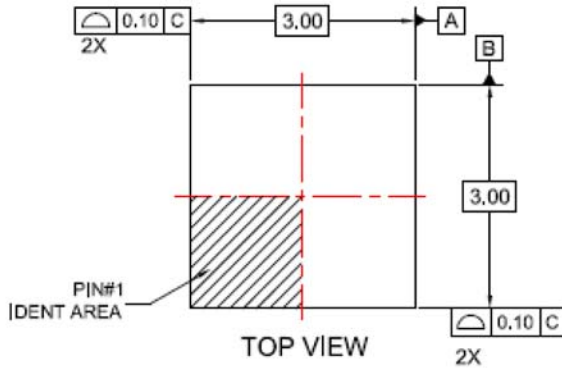


Figure 28. SyncFET<sup>™</sup> body diode reverse leakage versus drain-source voltage

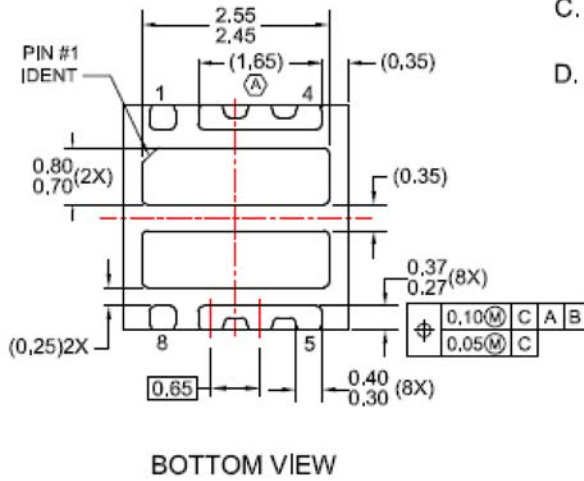
### Dimensional Outline and Pad Layout



RECOMMENDED LAND PATTERN

**NOTES:**


- A. DOES NOT FULLY CONFORM TO JEDEC REGISTRATION, MO-229,
- B. DIMENSIONS ARE IN MILLIMETERS.
- C. DIMENSIONS AND TOLERANCES PER ASME Y14.5M, 1994
- D. LAND PATTERN RECOMMENDATION IS BASED ON FSC DESIGN ONLY





**TRADEMARKS**

The following includes registered and unregistered trademarks and service marks, owned by Fairchild Semiconductor and/or its global subsidiaries, and is not intended to be an exhaustive list of all such trademarks.

- |   |   |  |   |
|---|---|--|---|
| 2Cool™  | F-PFST™   | PowerTrench <sup>®</sup>   | The Power Franchise <sup>®</sup>  |
| AccuPower™  | FRFET <sup>®</sup>  | PowerXST™  | the Power <sup>®</sup>  |
| AX-CAPT™*   | Global Power Resource <sup>SM</sup>   | Programmable Active Droop™   | franchise <sup>®</sup>  |
| BitSiC <sup>®</sup>   | Green Bridge™   | QFET <sup>®</sup>  | TinyBoost™  |
| Build it Now™   | Green FPS™  | QST™   | TinyBuck™   |
| CorePLUSTM  | Green FPS™ e-Series™  | Quiet Series™  | TinyCalc™   |
| CorePOWER™  | Gmax™   | RapidConfigure™  | TinyLogic <sup>®</sup>  |
| CROSSVOLT™  | GTO™  |  ™  | TINYOPTO™   |
| CTL™  | IntelliMAX™   | Saving our world, 1mW/W/kW at a time™  | TinyPower™  |
| Current Transfer Logic™   | ISOPLANAR™  | SignalWise™  | TinyPWM™  |
| DEUXPEED <sup>®</sup>   | Marking Small Speakers Sound Louder and Better™                                   | SmartMax™  | TinyWire™   |
| Dual Cool™  | MegaBuck™   | SMART START™   | TranSiC <sup>®</sup>  |
| EcoSPARK <sup>®</sup>   | MICROCOUPLER™   | Solutions for Your Success™  | TriFault Detect™  |
| EfficientMax™   | MicroFET™   | SPM <sup>®</sup>   | TRUECURRENT <sup>®</sup> *  |
| ESBC™   | MicroPak™   | STEALTH™   | μSerDes™  |
|  ™ | MicroPak2™  | SuperFET <sup>®</sup>  |  |
| Fairchild <sup>®</sup>  | MillerDrive™  | SuperSOT™_3  | UHC <sup>®</sup>  |
| Fairchild Semiconductor <sup>®</sup>  | MotionMax™  | SuperSOT™_6  | Ultra FRFET™  |
| FACT Quiet Series™  | Motion-SPM™   | SuperSOT™_8  | UniFET™   |
| FACT <sup>®</sup>   | mWSaver™  | SupreMOS <sup>®</sup>  | VCX™  |
| FAST <sup>®</sup>   | OptoHiT™  | SyncFET™   | VisualMax™  |
| FastvCore™  | OPTOLOGIC <sup>®</sup>  | Sync-Lock™   | VoltagePlus™  |
| FETBench™   | OPTOPLANAR <sup>®</sup>   |  ™* | XST™  |
| FlashWriter <sup>®</sup> *  |  |  |   |
| FPS™  |   |  |   |

\*Trademarks of System General Corporation, used under license by Fairchild Semiconductor.

**DISCLAIMER**

FAIRCHILD SEMICONDUCTOR RESERVES THE RIGHT TO MAKE CHANGES WITHOUT FURTHER NOTICE TO ANY PRODUCTS HEREIN TO IMPROVE RELIABILITY, FUNCTION, OR DESIGN. FAIRCHILD DOES NOT ASSUME ANY LIABILITY ARISING OUT OF THE APPLICATION OR USE OF ANY PRODUCT OR CIRCUIT DESCRIBED HEREIN; NEITHER DOES IT CONVEY ANY LICENSE UNDER ITS PATENT RIGHTS, NOR THE RIGHTS OF OTHERS. THESE SPECIFICATIONS DO NOT EXPAND THE TERMS OF FAIRCHILD'S WORLDWIDE TERMS AND CONDITIONS, SPECIFICALLY THE WARRANTY THEREIN, WHICH COVERS THESE PRODUCTS.

**LIFE SUPPORT POLICY**

FAIRCHILD'S PRODUCTS ARE NOT AUTHORIZED FOR USE AS CRITICAL COMPONENTS IN LIFE SUPPORT DEVICES OR SYSTEMS WITHOUT THE EXPRESS WRITTEN APPROVAL OF FAIRCHILD SEMICONDUCTOR CORPORATION.

As used here in:

- Life support devices or systems are devices or systems which, (a) are intended for surgical implant into the body or (b) support or sustain life, and (c) whose failure to perform when properly used in accordance with instructions for use provided in the labeling, can be reasonably expected to result in a significant injury of the user.
- A critical component in any component of a life support, device, or system whose failure to perform can be reasonably expected to cause the failure of the life support device or system, or to affect its safety or effectiveness.

**ANTI-COUNTERFEITING POLICY**

Fairchild Semiconductor Corporation's Anti-Counterfeiting Policy. Fairchild's Anti-Counterfeiting Policy is also stated on our external website, www.Fairchildsemi.com, under Sales Support. Counterfeiting of semiconductor parts is a growing problem in the industry. All manufactures of semiconductor products are experiencing counterfeiting of their parts. Customers who inadvertently purchase counterfeit parts experience many problems such as loss of brand reputation, substandard performance, failed application, and increased cost of production and manufacturing delays. Fairchild is taking strong measures to protect ourselves and our customers from the proliferation of counterfeit parts. Fairchild strongly encourages customers to purchase Fairchild parts either directly from Fairchild or from Authorized Fairchild Distributors who are listed by country on our web page cited above. Products customers buy either from Fairchild directly or from Authorized Fairchild Distributors are genuine parts, have full traceability, meet Fairchild's quality standards for handling and storage and provide access to Fairchild's full range of up-to-date technical and product information. Fairchild and our Authorized Distributors will stand behind all warranties and will appropriately address and warranty issues that may arise. Fairchild will not provide any warranty coverage or other assistance for parts bought from Unauthorized Sources. Fairchild is committed to combat this global problem and encourage our customers to do their part in stopping this practice by buying direct or from authorized distributors.

**PRODUCT STATUS DEFINITIONS**

**Definition of Terms**

Datasheet Identification	Product Status	Definition
Advance Information	Formative / In Design	Datasheet contains the design specifications for product development. Specifications may change in any manner without notice.
Preliminary	First Production	Datasheet contains preliminary data; supplementary data will be published at a later date. Fairchild Semiconductor reserves the right to make changes at any time without notice to improve design.
No Identification Needed	Full Production	Datasheet contains final specifications. Fairchild Semiconductor reserves the right to make changes at any time without notice to improve the design.
Obsolete	Not In Production	Datasheet contains specifications on a product that is discontinued by Fairchild Semiconductor. The datasheet is for reference information only.