

FS14VS-9

HIGH-SPEED SWITCHING USE

FS14VS-9



- V_{DSS} 450V
- r_{DS (ON)} (MAX) 0.52Ω
- I_D 14A

OUTLINE DRAWING Dimensions in mm

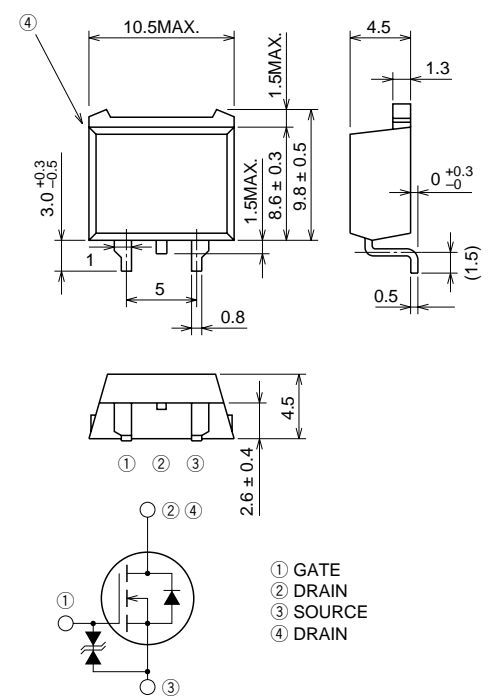

① GATE
② DRAIN
③ SOURCE
④ DRAIN

TO-220S

APPLICATION

SMPS, DC-DC Converter, battery charger, power supply of printer, copier, HDD, FDD, TV, VCR, personal computer etc.

MAXIMUM RATINGS (T_c = 25°C)

Symbol	Parameter	Conditions	Ratings	Unit
V _{DSS}	Drain-source voltage	V _{GS} = 0V	450	V
V _{GSS}	Gate-source voltage	V _{DS} = 0V	±30	V
I _D	Drain current		14	A
I _{DM}	Drain current (Pulsed)		42	A
P _D	Maximum power dissipation		150	W
T _{ch}	Channel temperature		-55 ~ +150	°C
T _{stg}	Storage temperature		-55 ~ +150	°C
—	Weight	Typical value	1.2	g

ELECTRICAL CHARACTERISTICS (T_{ch} = 25°C)

Symbol	Parameter	Test conditions	Limits			Unit
			Min.	Typ.	Max.	
V (BR) DSS	Drain-source breakdown voltage	I _D = 1mA, V _{GS} = 0V	450	—	—	V
V (BR) GSS	Gate-source breakdown voltage	I _G = ±100μA, V _{DS} = 0V	±30	—	—	V
I _{GSS}	Gate-source leakage current	V _{GS} = ±25V, V _{DS} = 0V	—	—	±10	μA
I _{DSS}	Drain-source leakage current	V _{DS} = 450V, V _{GS} = 0V	—	—	1	mA
V _{GS} (th)	Gate-source threshold voltage	I _D = 1mA, V _{DS} = 10V	2	3	4	V
r _{DS} (ON)	Drain-source on-state resistance	I _D = 7A, V _{GS} = 10V	—	0.40	0.52	Ω
V _{DS} (ON)	Drain-source on-state voltage	I _D = 7A, V _{GS} = 10V	—	2.8	3.6	V
y _{fs}	Forward transfer admittance	I _D = 7A, V _{DS} = 10V	4.5	7.0	—	S
C _{iss}	Input capacitance	V _{DS} = 25V, V _{GS} = 0V, f = 1MHz	—	1500	—	pF
C _{oss}	Output capacitance		—	180	—	pF
C _{rss}	Reverse transfer capacitance		—	30	—	pF
t _d (on)	Turn-on delay time		—	30	—	ns
t _r	Rise time	V _{DD} = 200V, I _D = 7A, V _{GS} = 10V, R _{GEN} = R _{GS} = 50Ω	—	50	—	ns
t _d (off)	Turn-off delay time		—	130	—	ns
t _f	Fall time		—	50	—	ns
V _{SD}	Source-drain voltage		I _S = 7A, V _{GS} = 0V	—	1.5	2.0
R _{th} (ch-c)	Thermal resistance	Channel to case	—	—	0.83	°C/W

PERFORMANCE CURVES

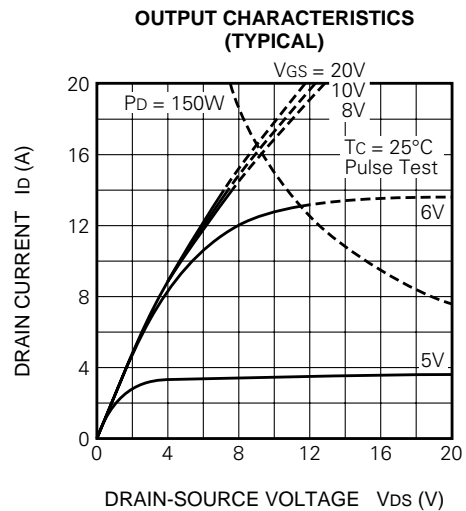
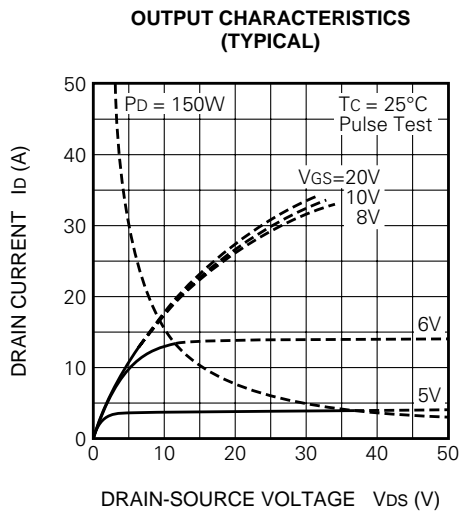
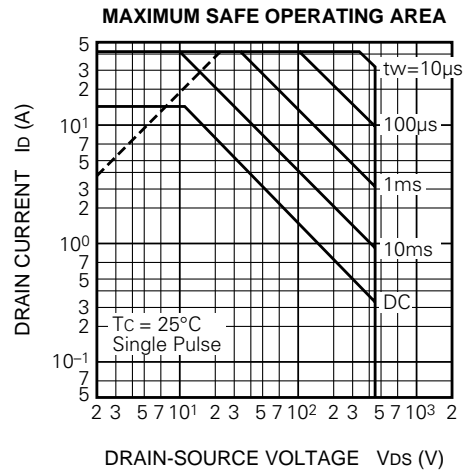
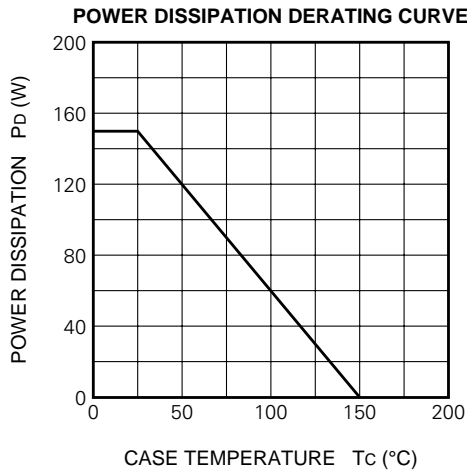

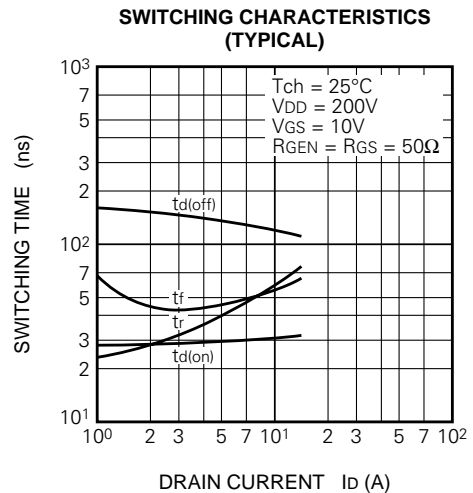
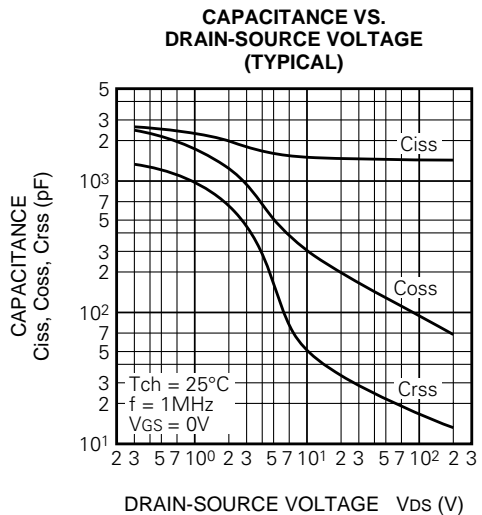
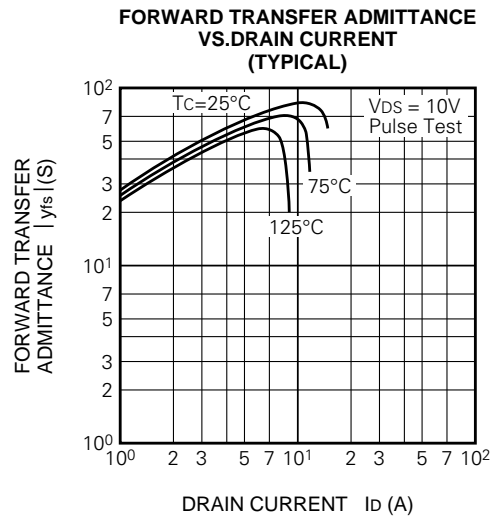
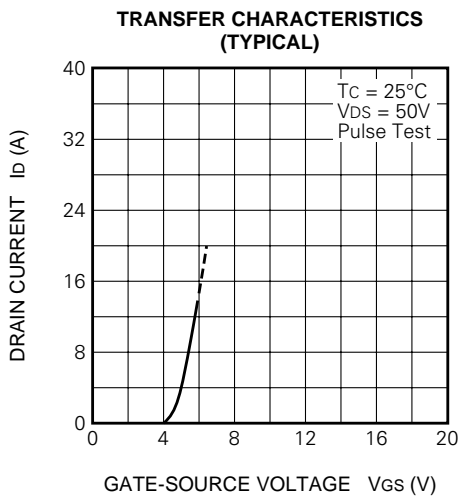
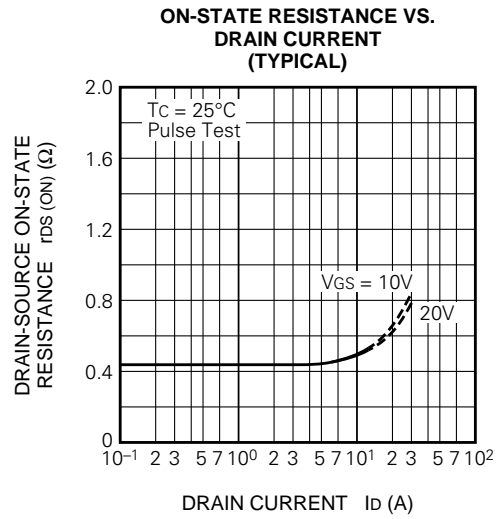
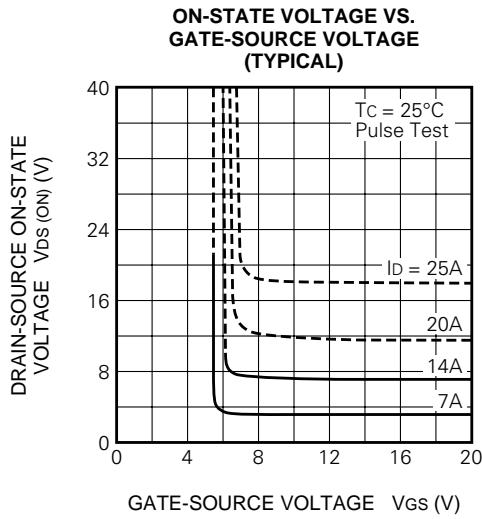

GATE-SOURCE VOLTAGE VS. GATE CHARGE (TYPICAL)

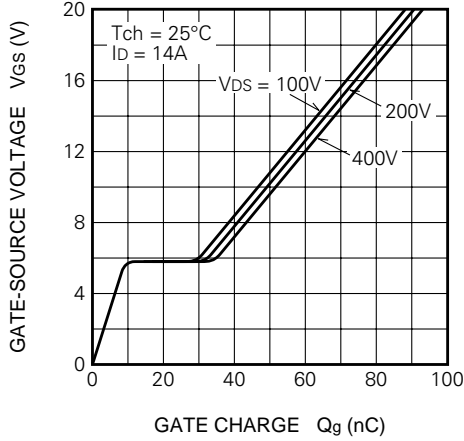

SOURCE-DRAIN DIODE FORWARD CHARACTERISTICS (TYPICAL)

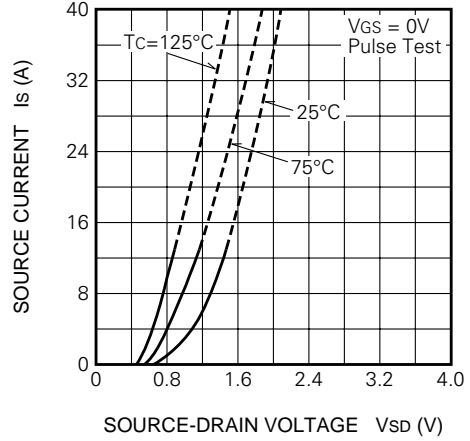

ON-STATE RESISTANCE VS. CHANNEL TEMPERATURE (TYPICAL)

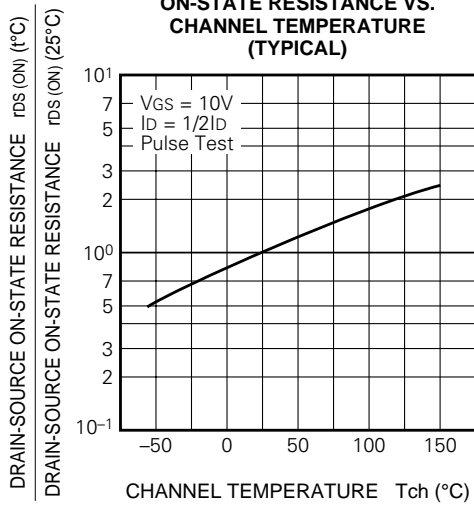

THRESHOLD VOLTAGE VS. CHANNEL TEMPERATURE (TYPICAL)

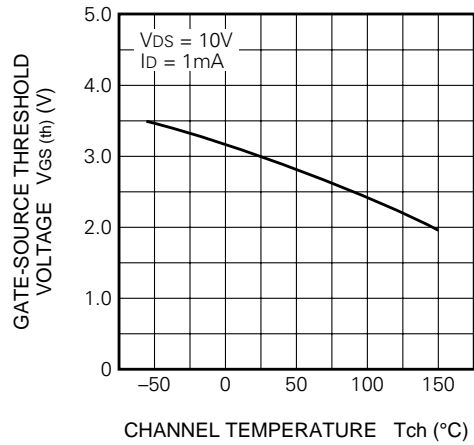

BREAKDOWN VOLTAGE VS. CHANNEL TEMPERATURE (TYPICAL)

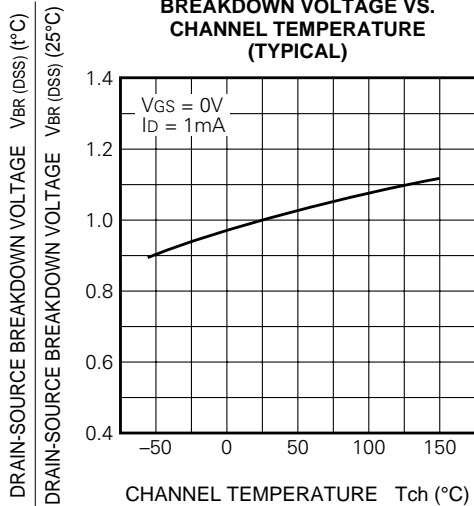

TRANSIENT THERMAL IMPEDANCE CHARACTERISTICS

