

IRF9240/9241/9242/9243
IRFP9240/9241/9242/9243
IRF9640/9641/9642/9643

P-CHANNEL
POWER MOSFETS

Preliminary Specifications

- 200 Volt, 0.5 Ohm SFET

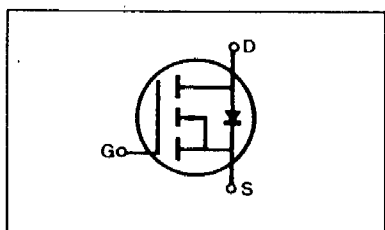

FEATURES

- Low $R_{DS(on)}$
- Improved inductive ruggedness
- Fast switching times
- Rugged polysilicon gate cell structure
- Low input capacitance
- Extended safe operating area
- Improved high temperature reliability

PRODUCT SUMMARY

Part Number	V_{DS}	$R_{DS(on)}$	I_D
IRF/IRFP9240, IRF9640	-200V	0.5 Ω	-11A
IRF/IRFP9241, IRF9641	-150V	0.5 Ω	-11A
IRF/IRFP9242, IRF9642	-200V	0.7 Ω	-9.0A
IRF/IRFP9243, IRF9643	-150V	0.7 Ω	-9.0A

PACKAGE STYLE

Package Type	Part Number
TO-3	IRF9240/9241/9242/9243
TO-3P	IRFP9240/9241/9242/9243
TO-220	IRF9640/9641/9642/9643

MAXIMUM RATINGS

Characteristic	Symbol	IRF/IRFP				Unit
		9240 9640	9241 9641	9242 9642	9243 9643	
Drain-Source Voltage (1)	V_{DS}	-200	-150	-200	-150	Vdc
Drain-Gate Voltage ($R_{GS}=1.0M\Omega$) (1)	V_{DGR}	-200	-150	-200	-150	vdc
Gate-Source Voltage	V_{GS}	± 20				Vdc
Continuous Drain Current $T_C=25^\circ C$	I_D	-11	-11	-9.0	-9.0	Adc
Continuous Drain Current $T_C=100^\circ C$	I_D	-7.0	-7.0	-6.0	-6.0	Adc
Drain Current—Pulsed (3)	I_{DM}	-44	-44	-36	-36	Adc
Gate Current—Pulsed	I_{GM}	± 1.5				Adc
Total Power Dissipation @ $T_C=25^\circ C$	P_D	125				Watts
Derate above $25^\circ C$		1.0				W/ $^\circ C$
Operating and Storage Junction Temperature Rangy	T_J, T_{stg}	-55 to 150				$^\circ C$
Maximum Lead Temp. for Soldering Purposes, 1/8" from case for 5 seconds	T_L	300				$^\circ C$

- Notes:** (1) $T_J=25^\circ C$ to $150^\circ C$
 (2) Pulse test: Pulse width $\leq 300\mu s$, Duty Cycle $\leq 2\%$
 (3) Repetitive rating: Pulse width limited by max. junction temperature



NJ Semi-Conductors reserves the right to change test conditions, parameter limits and package dimensions without notice. Information furnished by NJ Semi-Conductors is believed to be both accurate and reliable at the time of going to press. However, NJ Semi-Conductors assumes no responsibility for any errors or omissions discovered in its use. NJ Semi-Conductors encourages customers to verify that datasheets are current before placing orders.

IRF9240/9241/9242/9243
IRFP9240/9241/9242/9243
IRF9640/9641/9642/9643

P-CHANNEL
POWER MOSFETS

ELECTRICAL CHARACTERISTICS ($T_C=25^\circ\text{C}$ unless otherwise specified)

Characteristic	Symbol	Type	Min	Typ	Max	Units	Test Conditions
Drain-Source Breakdown Voltage	BV _{DSS}	IRF9240/2 IRFP9240/2 IRF9640/2	-200	—	—	V	V _{GS} =0V
		IRF9241/3 IRFP9241/3 IRF9641/3	-150	—	—	V	I _D =-250μA
Gate Threshold Voltage	V _{GS(th)}	ALL	-2.0	—	-4.0	V	V _{DS} =V _{GS} , I _D =-250μA
Gate-Source Leakage Forward	I _{GSS}	ALL	—	—	-100	nA	V _{GS} =-20V
Gate-Source Leakage Reverse	I _{GSS}	ALL	—	—	100	nA	V _{GS} =20V
Zero Gate Voltage Drain Current	I _{DSS}	ALL	—	—	-250	μA	V _{DS} =Max. Rating, V _{GS} =0V
		ALL	—	—	-1000	μA	V _{DS} =Max. Rating×0.8, V _{GS} =0V, T _C =125°C
On-State Drain-Source Current (2)	I _{D(on)}	IRF9240/1 IRFP9240/1 IRF9640/1	-11	—	—	A	V _{DS} >I _{D(on)} ×R _{DS(on) max.} , V _{GS} =-10V
		IRF9642 IRF9643	-9.0	—	—	A	
Static Drain-Source On-State Resistance (2)	R _{DS(on)}	IRF9240/1 IRFP9240/1 IRF9640/1	—	—	0.5	Ω	V _{GS} =-10V, I _D =-6.0A
		IRF9242/3 IRFP9242/3 IRF9642/3	—	—	0.7	Ω	
		ALL	—	—	—	—	
Forward Transconductance (2)	g _{fs}	ALL	4.0	—	—	S	V _{DS} >I _{D(on)} ×R _{DS(on) max.} , I _D =-6.0A
Input Capacitance	C _{iss}	ALL	—	—	1300	pF	
Output Capacitance	C _{oss}	ALL	—	—	450	pF	V _{GS} =0V, V _{DS} =-25V, f=1.0MHz
Reverse Transfer Capacitance	C _{rss}	ALL	—	—	250	pF	
Turn-On Delay Time	t _{d(on)}	ALL	—	—	30	ns	
Rise Time	t _r	ALL	—	—	15	ns	V _{DD} =0.5BV _{DSS} , I _D =-6.0A, Z _O =4.7Ω, (MOSFET switching times are essentially independent of operating temperature.)
Turn-Off Delay Time	t _{d(off)}	ALL	—	—	18	ns	
Fall Time	t _f	ALL	—	—	12	ns	
Total Gate Charge (Gate-Source Plus Gate-Drain)	Q _g	ALL	—	—	90	nC	V _{GS} =-15V, I _D =-22A, V _{DS} =0.8 Max. Rating (Gate charge is essentially independent of operating temperature.)
Gate-Source Charge	Q _{gs}	ALL	—	—	30	nC	
Gate-Drain ("Miller") Charge	Q _{gd}	ALL	—	—	60	nC	

THERMAL RESISTANCE

Junction-to-Case	R _{thJC}	ALL	—	—	1.0	K/W	
Case-to-Sink	R _{thCS}	ALL	—	1.0	—	K/W	Mounting surface flat, smooth, and greased
Junction-to-Ambient	R _{thJA}	IRFPXXXX IRF96XX	—	—	80		Free Air Operation
		IRF92XX	—	—	30	K/W	

- Notes:** (1) T_J=25°C to 150°C
(2) Pulse test: Pulse width≤300μs, Duty Cycle≤2%
(3) Repetitive rating: Pulse width limited by max. junction temperature

IRF9240/9241/9242/9243
IRFP9240/9241/9242/9243
IRF9640/9641/9642/9643

P-CHANNEL
POWER MOSFETS

SOURCE-DRAIN DIODE RATINGS AND CHARACTERISTICS

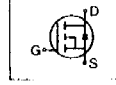
Characteristic	Symbol	Type	Min	Typ	Max	Units	Test Conditions
Continuous Source Current (Body Diode)	I_S	IRF9240/1 IRFP9240/1 IRF9640/1	—	—	-11	A	Modified MOSFET symbol showing the integral reverse P-N junction rectifier 
		IRF9242/3 IRFP9242/3 IRF9642/3	—	—	-9.0	A	
Pulse Source Current (Body Diode) (3)	I_{SM}	IRF9240/1 IRFP9240/1 IRF9640/1	—	—	-44	A	
		IRF9242/3 IRFP9242/3 IRF9642/3	—	—	-36	A	
Diode Forward Voltage (2)	V_{SD}	IRF9240/1 IRFP9240/1 IRF9640/1	—	—	-4.6	V	$T_C=25^\circ\text{C}$, $I_S=-11\text{A}$, $V_{GS}=0\text{V}$
		IRF9242/3 IRFP9242/3 IRF9642/3	—	—	-4.4	V	$T_C=25^\circ\text{C}$, $I_S=-9.0\text{A}$, $V_{GS}=0\text{V}$
Reverse Recovery Time	t_{rr}	ALL	—	—	—	ns	$T_J=150^\circ\text{C}$, $I_F=-11\text{A}$, $dI_F/dt=100\text{A}/\mu\text{s}$

Notes: (1) $T_J=25^\circ\text{C}$ to 150°C (2) Pulse test: Pulse width $\leq 300\mu\text{s}$, Duty Cycle $\leq 2\%$
(3) Repetitive rating: Pulse width limited by max. junction temperature

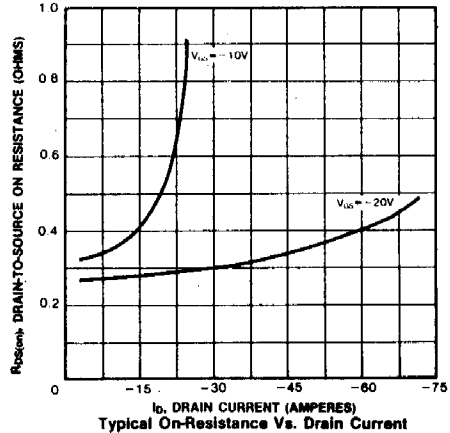
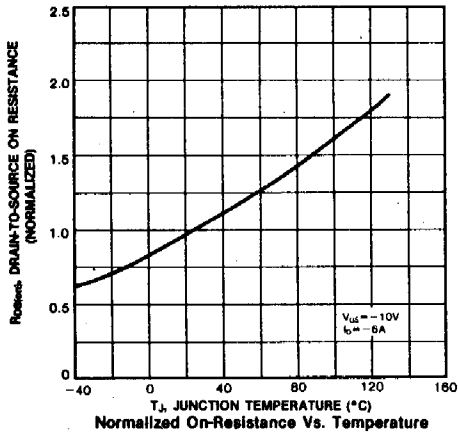
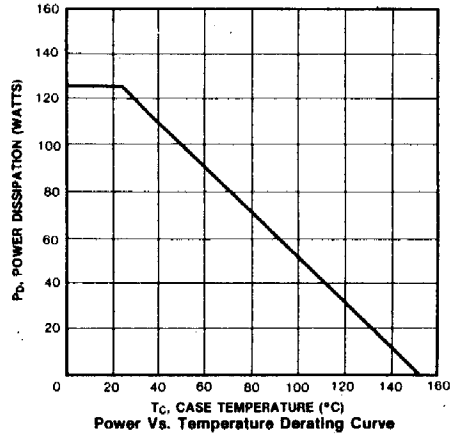
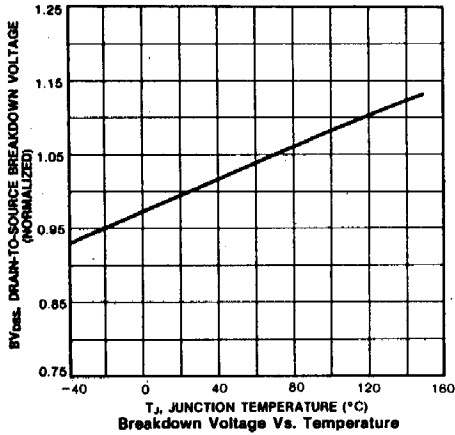

TO-3P

Unit: mm

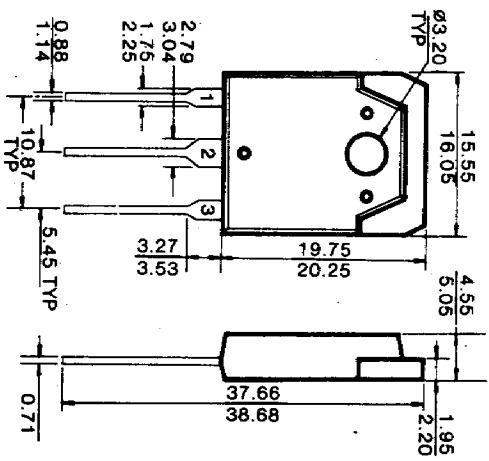

1. Gate 2. Drain 3. Source