

IRG4BC10KD

INSULATED GATE BIPOLAR TRANSISTOR WITH
 ULTRAFAST SOFT RECOVERY DIODE

Short Circuit Rated
 UltraFast IGBT

Features

- High short circuit rating optimized for motor control, $t_{sc} = 10\mu s$, @360V V_{CE} (start), $T_J = 125^\circ C$, $V_{GE} = 15V$
- Combines low conduction losses with high switching speed
- Tighter parameter distribution and higher efficiency than previous generations
- IGBT co-packaged with HEXFRED™ ultrafast, ultrasoft recovery antiparallel diodes

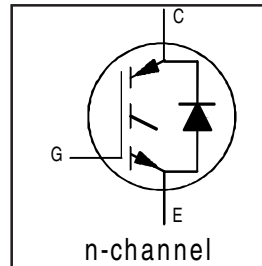

| |
|-----------------------------------|
| $V_{CES} = 600V$ |
| $V_{CE(on)} \text{ typ.} = 2.39V$ |
| @ $V_{GE} = 15V, I_C = 5.0A$ |

Benefits

- Latest generation 4 IGBTs offer highest power density motor controls possible
- HEXFRED™ diodes optimized for performance with IGBTs. Minimized recovery characteristics reduce noise, EMI and switching losses

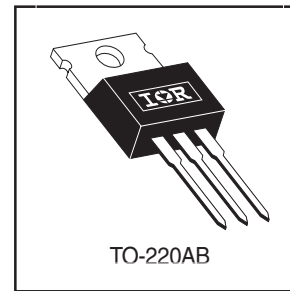

Absolute Maximum Ratings

| | Parameter | Max. | Units |
|---------------------------|------------------------------------|---------------------|------------|
| V_{CES} | Collector-to-Emitter Voltage | 600 | V |
| $I_C @ T_C = 25^\circ C$ | Continuous Collector Current | 9.0 | A |
| $I_C @ T_C = 100^\circ C$ | Continuous Collector Current | 5.0 | |
| I_{CM} | Pulsed Collector Current ① | 18 | |
| I_{LM} | Clamped Inductive Load Current ② | 18 | |
| $I_F @ T_C = 100^\circ C$ | Diode Continuous Forward Current | 4.0 | |
| I_{FM} | Diode Maximum Forward Current | 16 | |
| t_{sc} | Short Circuit Withstand Time | 10 | μs |
| V_{GE} | Gate-to-Emitter Voltage | ± 20 | V |
| $P_D @ T_C = 25^\circ C$ | Maximum Power Dissipation | 38 | W |
| $P_D @ T_C = 100^\circ C$ | Maximum Power Dissipation | 15 | |
| T_J | Operating Junction and | -55 to +150 | $^\circ C$ |
| T_{STG} | Storage Temperature Range | | |
| | Soldering Temperature, for 10 sec. | | |
| | Mounting Torque, 6-32 or M3 Screw. | 10 lbf•in (1.1 N•m) | |

Thermal Resistance

| | Parameter | Min. | Typ. | Max. | Units |
|-----------------|---|------|----------|------|--------------|
| $R_{\theta JC}$ | Junction-to-Case - IGBT | — | — | 3.3 | $^\circ C/W$ |
| $R_{\theta JC}$ | Junction-to-Case - Diode | — | — | 7.0 | |
| $R_{\theta CS}$ | Case-to-Sink, flat, greased surface | — | 0.50 | — | |
| $R_{\theta JA}$ | Junction-to-Ambient, typical socket mount | — | — | 80 | |
| Wt | Weight | — | 2 (0.07) | — | g (oz) |

IRG4BC10KD

Electrical Characteristics @ T_J = 25°C (unless otherwise specified)

| | Parameter | Min. | Typ. | Max. | Units | Conditions |
|--|---|------|------|------|-------|--|
| V _{(BR)CES} | Collector-to-Emitter Breakdown Voltage _f | 600 | — | — | V | V _{GE} = 0V, I _C = 250μA |
| ΔV _{(BR)CES} /ΔT _J | Temperature Coeff. of Breakdown Voltage | — | 0.58 | — | V/°C | V _{GE} = 0V, I _C = 1.0mA |
| V _{CE(on)} | Collector-to-Emitter Saturation Voltage | — | 2.39 | 2.62 | V | I _C = 5.0A V _{GE} = 15V |
| | | — | 3.25 | — | | I _C = 9.0A See Fig. 2, 5 |
| | | — | 2.63 | — | | I _C = 5.0A, T _J = 150°C |
| V _{GE(th)} | Gate Threshold Voltage | 3.0 | — | 6.5 | | V _{CE} = V _{GE} , I _C = 250μA |
| ΔV _{GE(th)} /ΔT _J | Temperature Coeff. of Threshold Voltage | — | -11 | — | mV/°C | V _{CE} = V _{GE} , I _C = 250μA |
| g _{fe} | Forward Transconductance „ | 1.2 | 1.8 | — | S | V _{CE} = 50V, I _C = 5.0A |
| I _{CES} | Zero Gate Voltage Collector Current | — | — | 250 | μA | V _{GE} = 0V, V _{CE} = 600V |
| | | — | — | 1000 | | V _{GE} = 0V, V _{CE} = 600V, T _J = 150°C |
| V _{FM} | Diode Forward Voltage Drop | — | 1.5 | 1.8 | V | I _C = 4.0A See Fig. 13 |
| | | — | 1.4 | 1.7 | | I _C = 4.0A, T _J = 150°C |
| I _{GES} | Gate-to-Emitter Leakage Current | — | — | ±100 | nA | V _{GE} = ±20V |

Switching Characteristics @ T_J = 25°C (unless otherwise specified)

| | Parameter | Min. | Typ. | Max. | Units | Conditions |
|--------------------------|---|------|------|------|-------|---|
| Q _g | Total Gate Charge (turn-on) | — | 19 | 29 | nC | I _C = 5.0A |
| Q _{ge} | Gate - Emitter Charge (turn-on) | — | 2.9 | 4.3 | | V _{CC} = 400V See Fig.8 |
| Q _{gc} | Gate - Collector Charge (turn-on) | — | 9.8 | 15 | | V _{GE} = 15V |
| t _{d(on)} | Turn-On Delay Time | — | 49 | — | ns | T _J = 25°C |
| t _r | Rise Time | — | 28 | — | | I _C = 5.0A, V _{CC} = 480V |
| t _{d(off)} | Turn-Off Delay Time | — | 97 | 150 | | V _{GE} = 15V, R _G = 100Ω |
| t _f | Fall Time | — | 140 | 210 | | Energy losses include "tail" and diode reverse recovery |
| E _{on} | Turn-On Switching Loss | — | 0.25 | — | mJ | See Fig. 9,10,14 |
| E _{off} | Turn-Off Switching Loss | — | 0.14 | — | | |
| E _{ts} | Total Switching Loss | — | 0.39 | 0.48 | | |
| t _{sc} | Short Circuit Withstand Time | 10 | — | — | μs | V _{CC} = 360V, T _J = 125°C V _{GE} = 15V, R _G = 100Ω, V _{CPK} < 500V |
| t _{d(on)} | Turn-On Delay Time | — | 46 | — | ns | T _J = 150°C, See Fig. 10,11,14 |
| t _r | Rise Time | — | 32 | — | | I _C = 5.0A, V _{CC} = 480V |
| t _{d(off)} | Turn-Off Delay Time | — | 100 | — | | V _{GE} = 15V, R _G = 100Ω |
| t _f | Fall Time | — | 310 | — | | Energy losses include "tail" and diode reverse recovery |
| E _{ts} | Total Switching Loss | — | 0.56 | — | mJ | |
| L _E | Internal Emitter Inductance | — | 7.5 | — | nH | Measured 5mm from package |
| C _{ies} | Input Capacitance | — | 220 | — | pF | V _{GE} = 0V |
| C _{oes} | Output Capacitance | — | 29 | — | | V _{CC} = 30V See Fig. 7 |
| C _{res} | Reverse Transfer Capacitance | — | 7.5 | — | | f = 1.0MHz |
| t _{rr} | Diode Reverse Recovery Time | — | 28 | 42 | ns | T _J = 25°C See Fig. 14 |
| | | — | 38 | 57 | | T _J = 125°C |
| I _{rr} | Diode Peak Reverse Recovery Current | — | 2.9 | 5.2 | A | T _J = 25°C See Fig. 15 |
| | | — | 3.7 | 6.7 | | T _J = 125°C |
| Q _{rr} | Diode Reverse Recovery Charge | — | 40 | 60 | nC | T _J = 25°C See Fig. 16 |
| | | — | 70 | 105 | | T _J = 125°C |
| di _{(rec)M} /dt | Diode Peak Rate of Fall of Recovery During t _b | — | 280 | — | A/μs | T _J = 25°C See Fig. 17 |
| | | — | 235 | — | | T _J = 125°C |

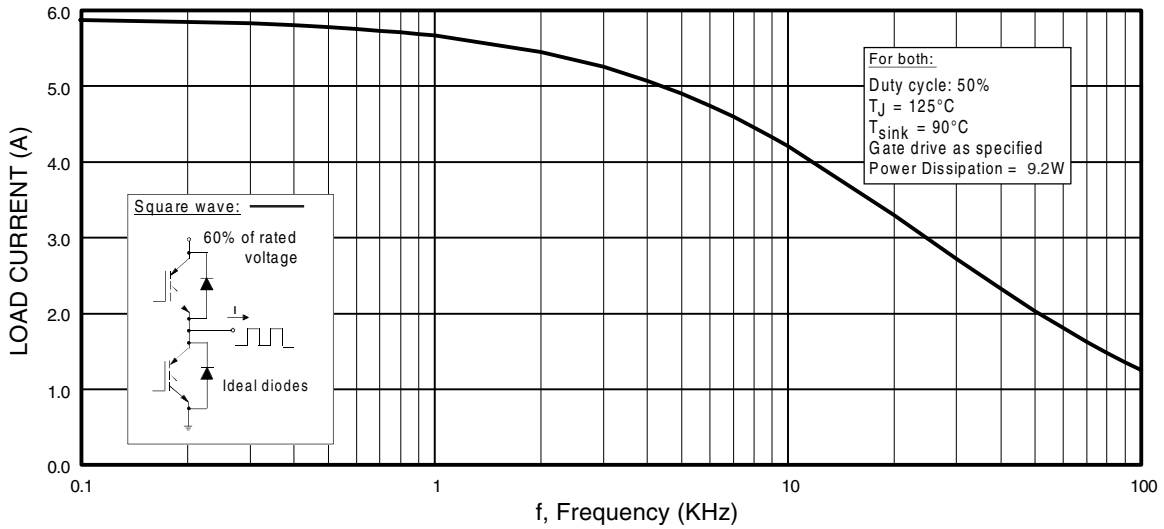

Fig. 1 - Typical Load Current vs. Frequency
 (Load Current = I_{RMS} of fundamental)

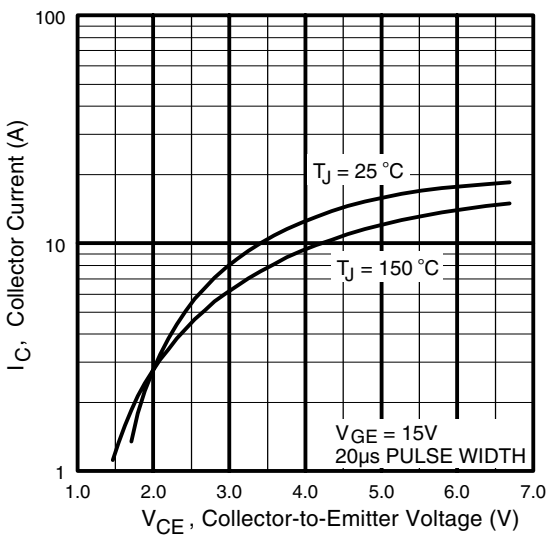

Fig. 2 - Typical Output Characteristics
www.irf.com

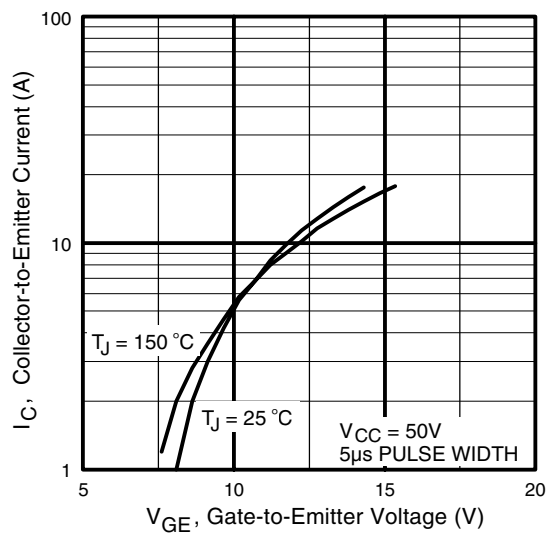

Fig. 3 - Typical Transfer Characteristics

IRG4BC10KD

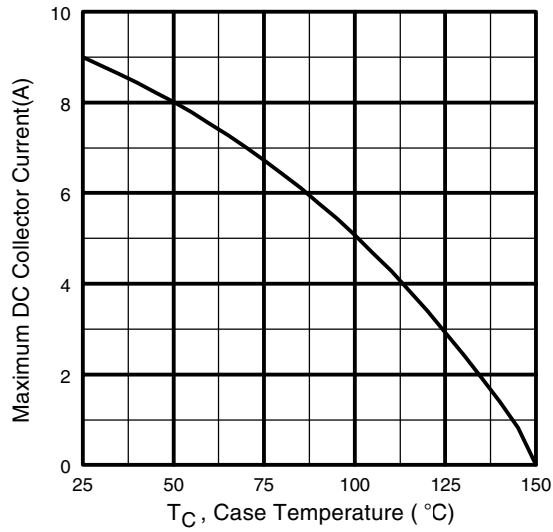

Fig. 4 - Maximum Collector Current vs. Case Temperature

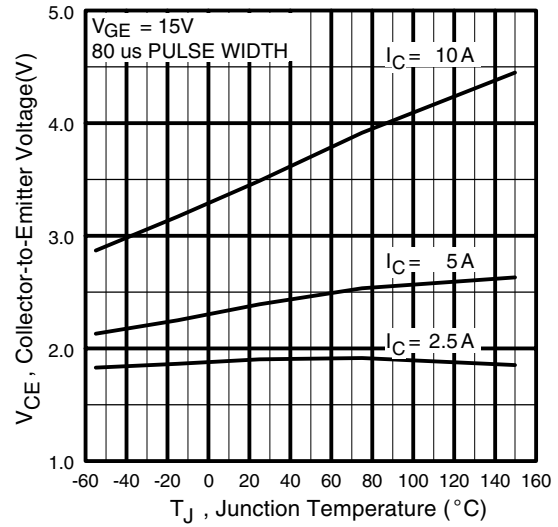

Fig. 5 - Typical Collector-to-Emitter Voltage vs. Junction Temperature

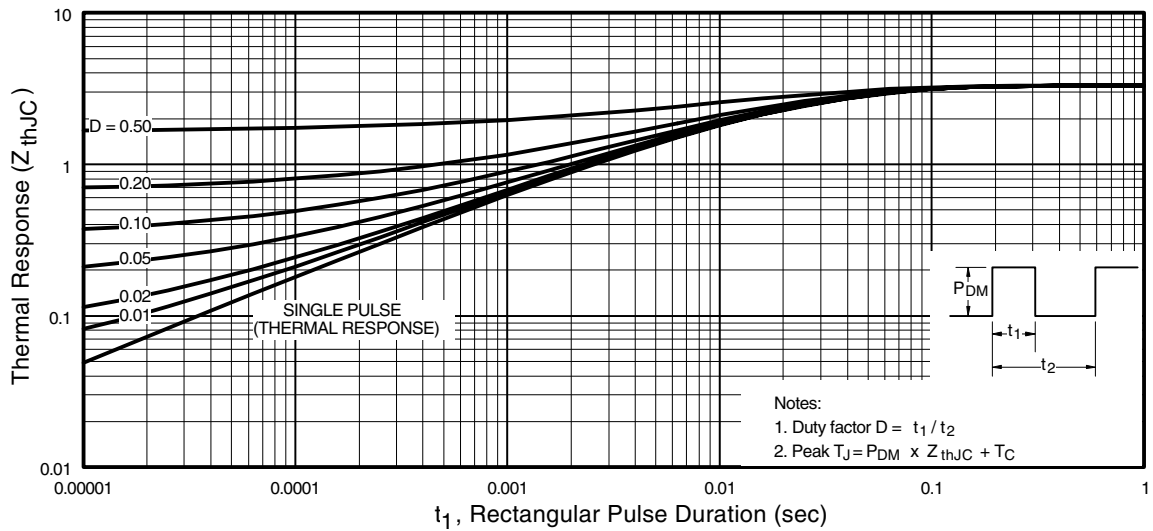

Fig. 6 - Maximum Effective Transient Thermal Impedance, Junction-to-Case

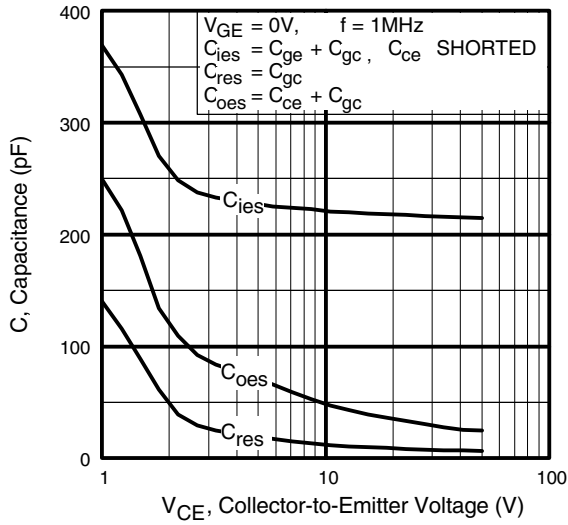

Fig. 7 - Typical Capacitance vs. Collector-to-Emitter Voltage

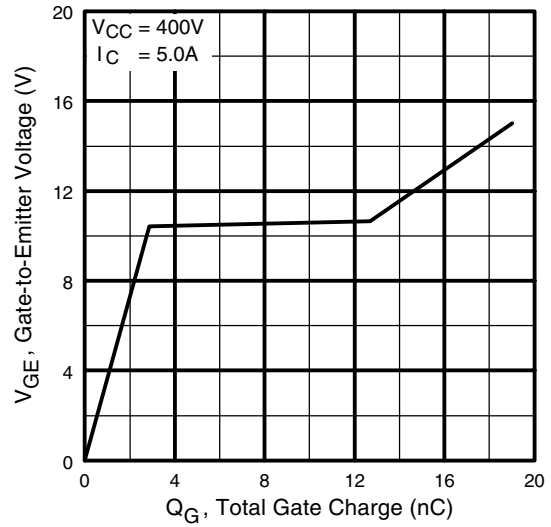

Fig. 8 - Typical Gate Charge vs. Gate-to-Emitter Voltage

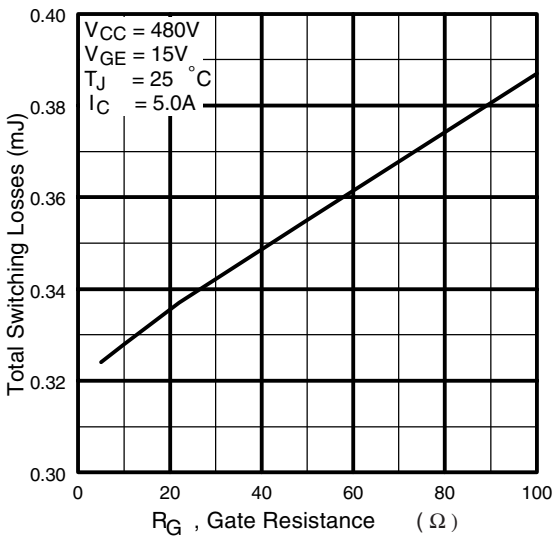

Fig. 9 - Typical Switching Losses vs. Gate Resistance

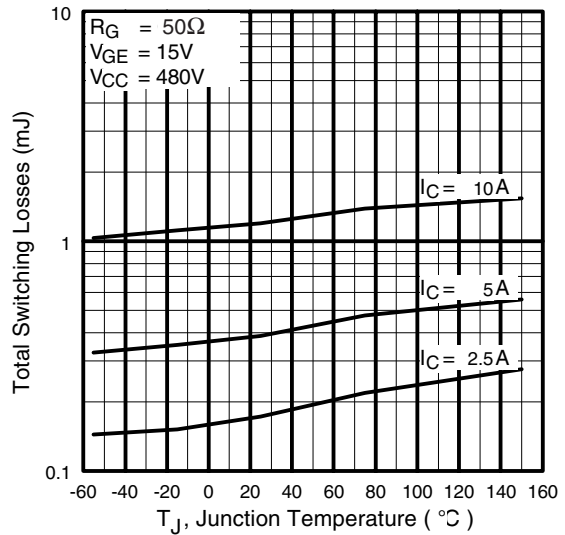

Fig. 10 - Typical Switching Losses vs. Junction Temperature

IRG4BC10KD

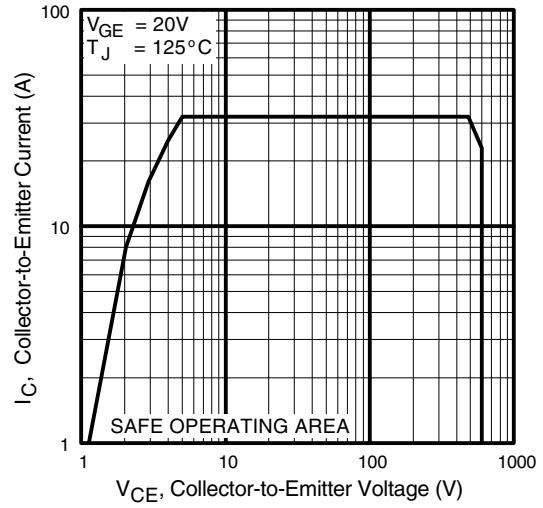
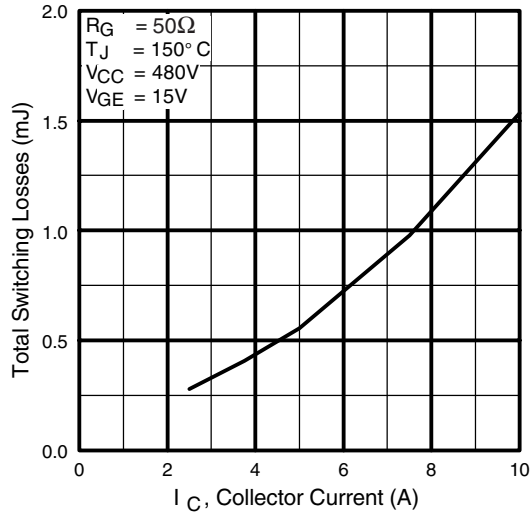

Fig. 11 - Typical Switching Losses vs. Collector-to-Emitter Current

Fig. 12 - Turn-Off SOA

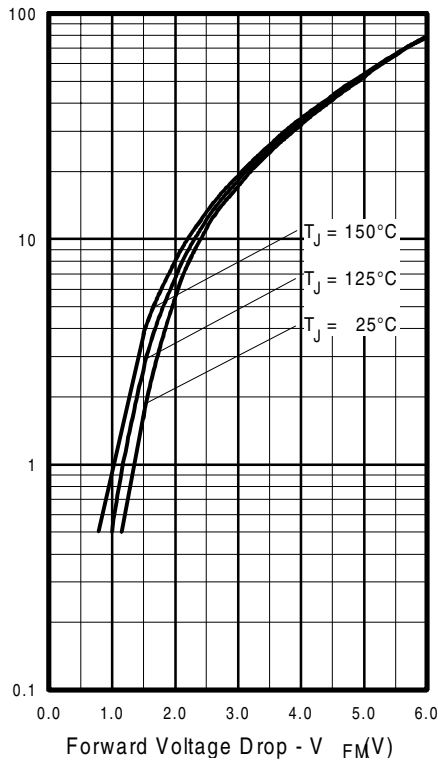

Fig. 13 - Maximum Forward Voltage Drop vs. Instantaneous Forward Current

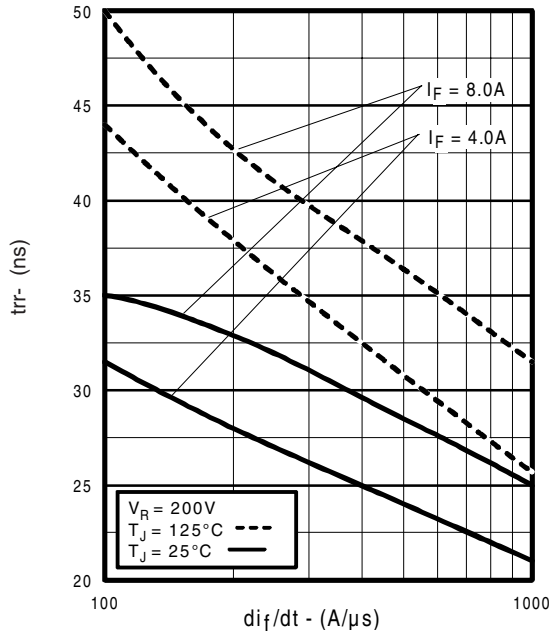

Fig. 14 - Typical Reverse Recovery vs. di_f/dt

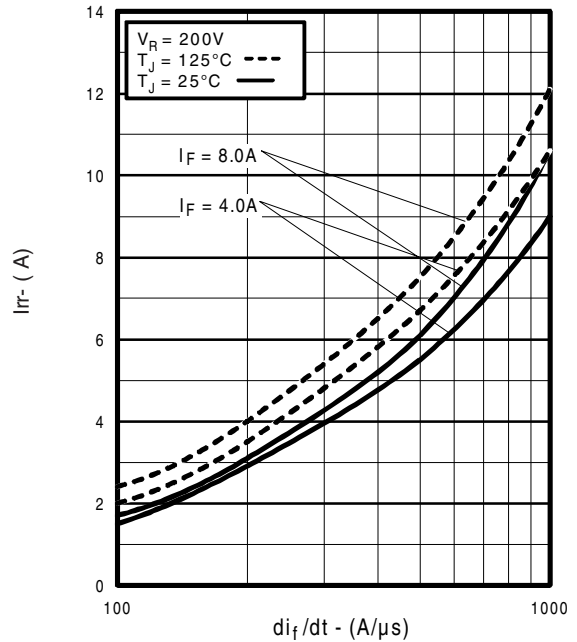

Fig. 15 - Typical Recovery Current vs. di_f/dt

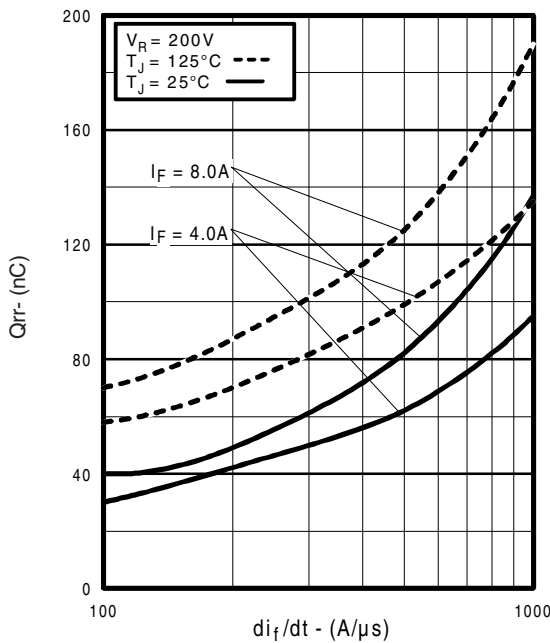

Fig. 16 - Typical Stored Charge vs. di_f/dt

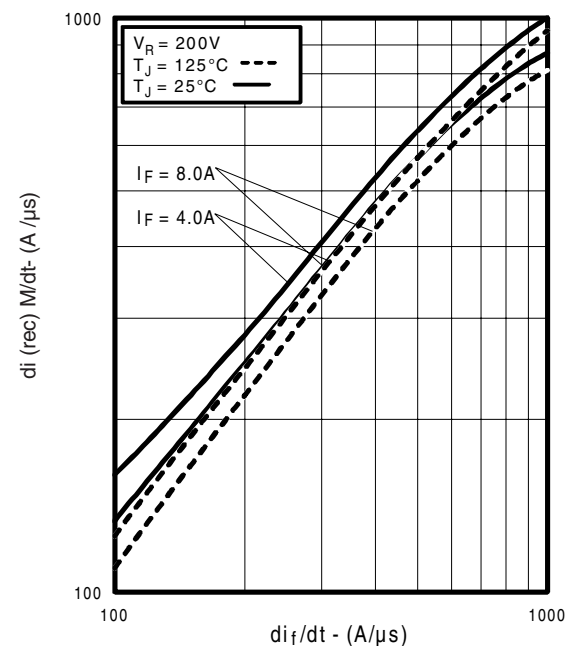

Fig. 17 - Typical $di_{(rec)}M/dt$ vs. di_f/dt ,

IRG4BC10KD

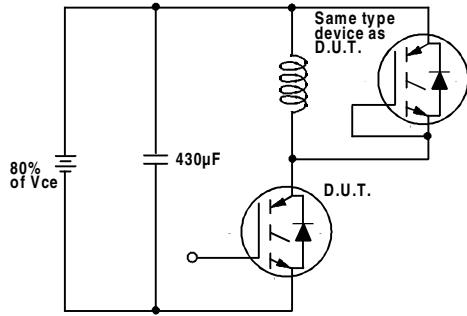

Fig. 18a - Test Circuit for Measurement of I_{LM} , E_{on} , $E_{off}(\text{diode})$, t_{rr} , Q_{rr} , I_{rr} , $t_{d(on)}$, t_r , $t_{d(off)}$, t_f

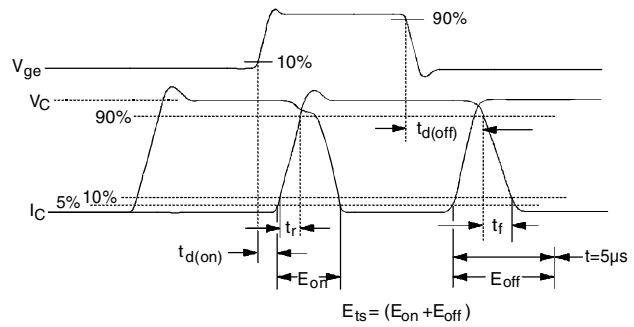

Fig. 18b - Test Waveforms for Circuit of Fig. 18a, Defining E_{off} , $t_{d(off)}$, t_f

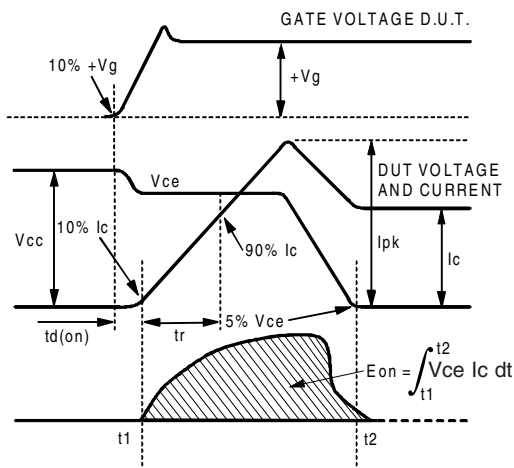

Fig. 18c - Test Waveforms for Circuit of Fig. 18a, Defining E_{on} , $t_{d(on)}$, t_r

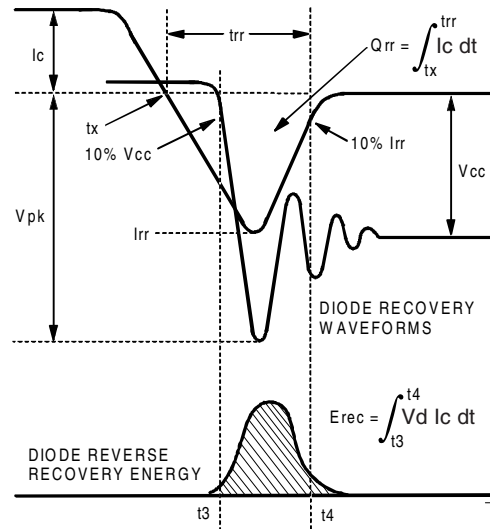

Fig. 18d - Test Waveforms for Circuit of Fig. 18a, Defining E_{rec} , t_{rr} , Q_{rr} , I_{rr}

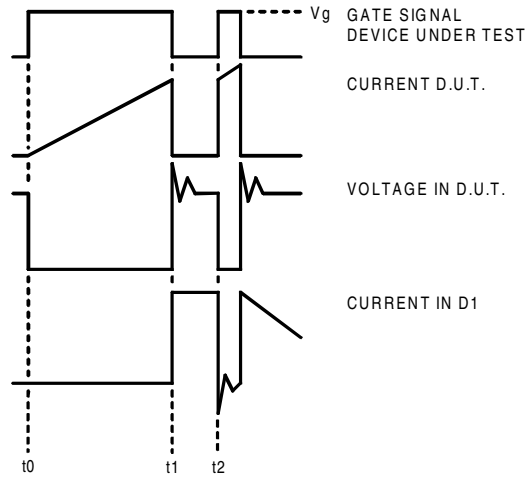

Figure 18e. Macro Waveforms for Figure 18a's Test Circuit

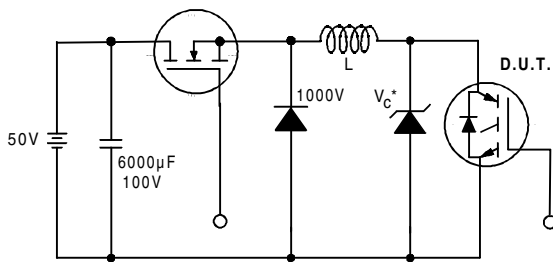

Figure 19. Clamped Inductive Load Test Circuit

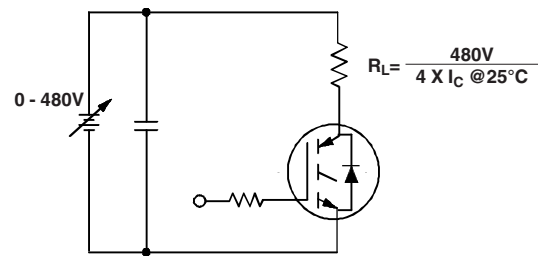

Figure 20. Pulsed Collector Current Test Circuit

IRG4BC10KD

Notes:

- ① Repetitive rating: $V_{GE}=20V$; pulse width limited by maximum junction temperature (figure 20)
- ② $V_{CC}=80\%(V_{CES})$, $V_{GE}=20V$, $L=10\mu H$, $R_G=100\Omega$ (figure 19)
- ③ Pulse width $\leq 80\mu s$; duty factor $\leq 0.1\%$.
- ④ Pulse width $5.0\mu s$, single shot.

Case Outline — TO-220AB

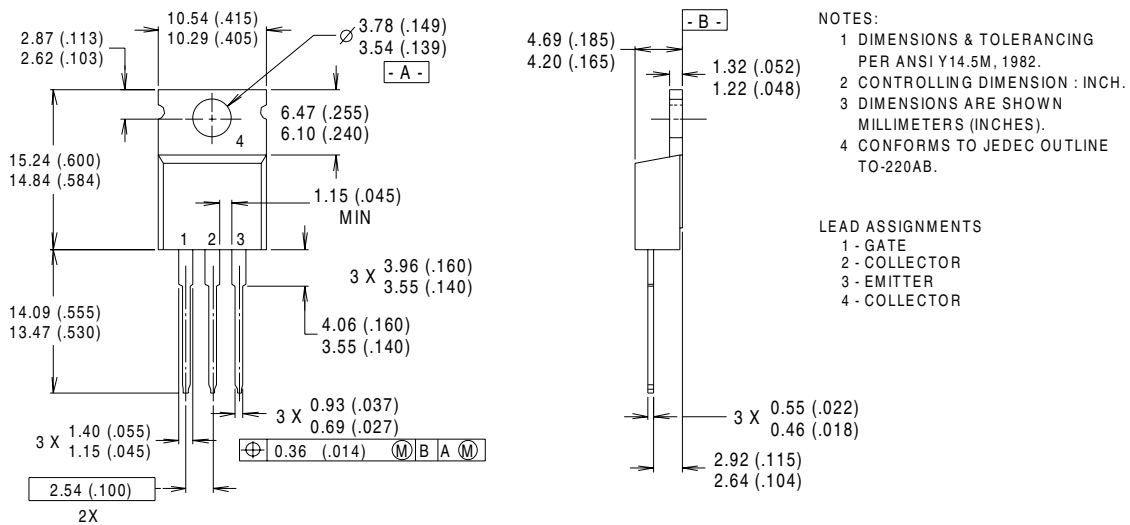

CONFORMS TO JEDEC OUTLINE TO-220AB

Dimensions in Millimeters and (Inches)