

## HEXFET® TRANSISTOR

## IRLF230

N-CHANNEL

### 200Volt, 0.40 Ω, HEXFET

The Logic Level 'L' series of power MOSFETs are designed to be operated with level logic gate-to-source voltage of 5V. In addition to the well established characteristics of HEXFETs, they have the added advantage of providing low drive requirements to interface power loads to logic level IC's and microprocessors.

Fields of application include: high speed power applications such as switching regulators, switching converters, motor drivers, solenoid and relay drivers.

The HEXFET technology is the key to International Rectifier's advance line of logic level power MOSFET transistors. The efficient geometry and unique processing of the HEXFET achieve very low on-state resistance combine with high transconductance.

### Product Summary

Part Number	BV <sub>DSS</sub>	R <sub>DS(on)</sub>	I <sub>D</sub>
IRLF230	200V	0.40Ω	5.2A

### Features:

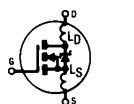
- Dynamic dv/dt Rating
- Logic Level Gate Drive
- R<sub>DS(on)</sub> Specific at V<sub>GS</sub> = 4V & 5V
- 150°C Operating Temperature
- Fast Switching
- Ease of Paralleling

### Absolute Maximum Ratings


	Parameter	IRLF230	Units
I <sub>D</sub> @ V <sub>GS</sub> = 5.0V, T <sub>C</sub> = 25°C	Continuous Drain Current	5.2	A
I <sub>D</sub> @ V <sub>GS</sub> = 5.0V, T <sub>C</sub> = 100°C	Continuous Drain Current	3.3	
I <sub>DM</sub>	Pulsed Drain Current ①	20	
P <sub>D</sub> @ T <sub>C</sub> = 25°C	Max. Power Dissipation	25	W
	Linear Derating Factor	0.20	W/K ⑤
V <sub>GS</sub>	Gate-to-Source Voltage	±10	V
dv/dt	Peak Diode Recovery dv/dt ③	4.2	V/ns
T <sub>J</sub>	Operating Junction	-55 to 150	°C
T <sub>STG</sub>	Storage Temperature Range		
	Lead Temperature	300(0.063 in.(1.6mm) from case for 10s)	
	Weight	0.98 (typical)	g

# IRLF230

## Electrical Characteristics @ T<sub>J</sub> = 25°C (Unless Otherwise Specified)

	Parameter	Min	Typ	Max	Units	Test Conditions
BV <sub>DSS</sub>	Drain-to-Source Breakdown Voltage	200	—	—	V	V <sub>GS</sub> = 0 V, I <sub>D</sub> = 250μA
ΔBV <sub>DSS</sub> /ΔT <sub>J</sub>	Temperature Coefficient of Breakdown Voltage	—	0.28	—	V/°C	Reference to 25°C, I <sub>D</sub> = 250μA
R <sub>DS(on)</sub>	Static Drain-to-Source On-State Resistance	—	—	0.40	Ω	V <sub>GS</sub> = 5.0V, I <sub>D</sub> = 3.1A ④
		—	—	0.50		V <sub>GS</sub> = 4.0V, I <sub>D</sub> = 2.6A
V <sub>GS(th)</sub>	Gate Threshold Voltage	1.0	—	2.0	V	V <sub>DS</sub> = V <sub>GS</sub> , I <sub>D</sub> = 250μA
g <sub>fs</sub>	Forward Transconductance	4.5	—	—	S (r̄)	V <sub>DS</sub> > 15V, I <sub>DS</sub> = 3.1A ④
I <sub>DSS</sub>	Zero Gate Voltage Drain Current	—	—	25	μA	V <sub>DS</sub> = 0.8 x Max Rating, V <sub>GS</sub> = 0V
		—	—	250		V <sub>DS</sub> = 0.8 x Max Rating V <sub>GS</sub> = 0V, T <sub>J</sub> = 125°C
I <sub>GSS</sub>	Gate-to-Source Leakage Forward	—	—	100	nA	V <sub>GS</sub> = 10 V
I <sub>GSS</sub>	Gate-to-Source Leakage Reverse	—	—	-100		V <sub>GS</sub> = -10V
Q <sub>g</sub>	Total Gate Charge	—	—	41	nC	V <sub>GS</sub> = 5.0V, I <sub>D</sub> = 5.2A
Q <sub>gs</sub>	Gate-to-Source Charge	—	—	4.9		V <sub>DS</sub> = Max Rating x 0.5
Q <sub>gd</sub>	Gate-to-Drain ('Miller') Charge	—	—	21		
t <sub>d(on)</sub>	Turn-On Delay Time	—	—	9.4	ns	V <sub>DD</sub> = 100V, I <sub>D</sub> = 5.2A, R <sub>G</sub> = 6.0Ω
t <sub>r</sub>	Rise Time	—	—	34		
t <sub>d(off)</sub>	Turn-Off Delay Time	—	—	43		
t <sub>f</sub>	Fall Time	—	—	26		
L <sub>D</sub>	Internal Drain Inductance	—	5.0	—	nH	<p>Measured from drain lead, 6mm (0.25 in) from package to center of die.</p> <p>Measured from source lead, 6mm (0.25 in) from package to source bonding pad.</p> 
L <sub>S</sub>	Internal Source Inductance	—	15	—		
C <sub>iss</sub>	Input Capacitance	—	1100	—	pF	V <sub>GS</sub> = 0V, V <sub>DS</sub> = 25 V f = 1.0MHz
C <sub>oss</sub>	Output Capacitance	—	230	—		
C <sub>rss</sub>	Reverse Transfer Capacitance	—	61	—		

## Source-Drain Diode Ratings and Characteristics

	Parameter	Min	Typ	Max	Units	Test Conditions
I <sub>S</sub>	Continuous Source Current (Body Diode)	—	—	5.2	A	Modified MOSFET symbol showing the integral reverse p-n junction rectifier. 
I <sub>SM</sub>	Pulse Source Current (Body Diode) ①	—	—	20		
V <sub>SD</sub>	Diode Forward Voltage	—	—	2.0	V	T <sub>J</sub> = 25°C, I <sub>S</sub> = 5.2A, V <sub>GS</sub> = 0V ④
t <sub>rr</sub>	Reverse Recovery Time	—	—	250	ns	T <sub>J</sub> = 25°C, I <sub>F</sub> = 5.2A, di/dt ≤ 100A/μs
Q <sub>RR</sub>	Reverse Recovery Charge	—	—	1.7	μC	V <sub>DD</sub> ≤ 50V ④
t <sub>on</sub>	Forward Turn-On Time	Intrinsic turn-on time is negligible. Turn-on speed is substantially controlled by L <sub>S</sub> + L <sub>D</sub> .				

## Thermal Resistance

	Parameter	Min.	Typ.	Max.	Units	Test Conditions
R <sub>thJC</sub>	Junction-to-Case	—	—	5.0	K/W	Typical socket mount
R <sub>thJA</sub>	Junction-to-Ambient	—	—	175		

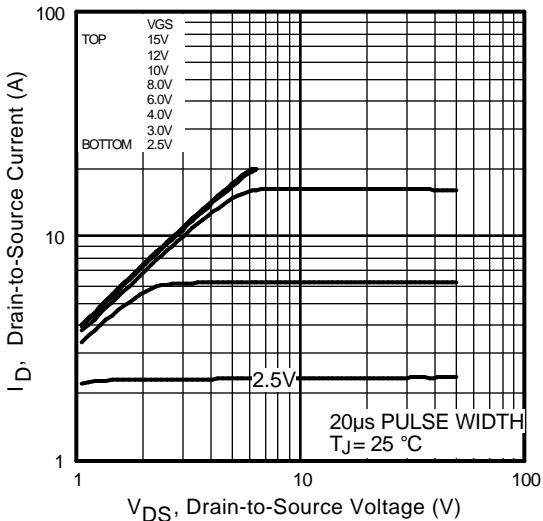


Fig 1. Typical Output Characteristics

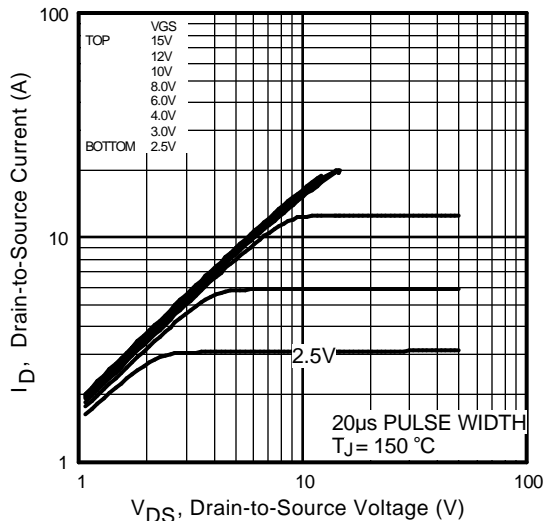


Fig 2. Typical Output Characteristics

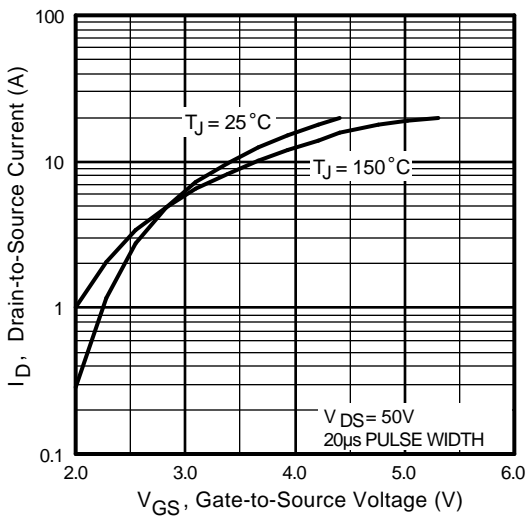


Fig 3. Typical Transfer Characteristics

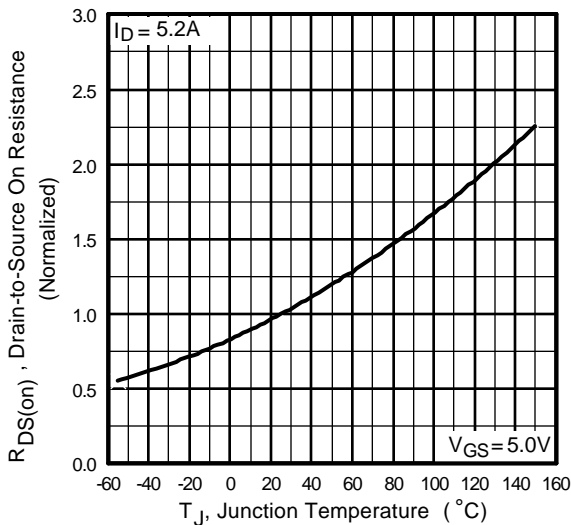
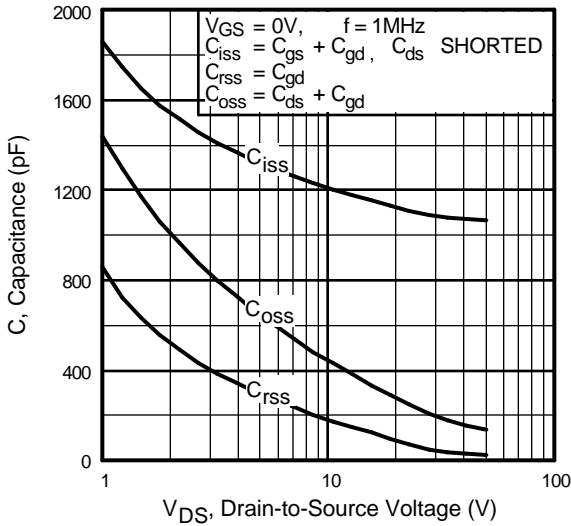
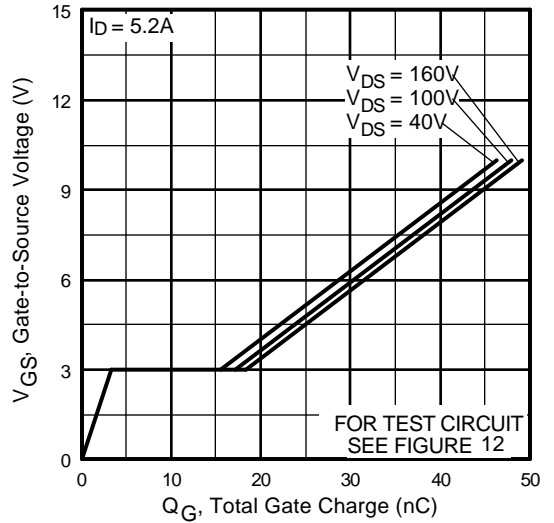


Fig 4. Normalized On-Resistance Vs. Temperature

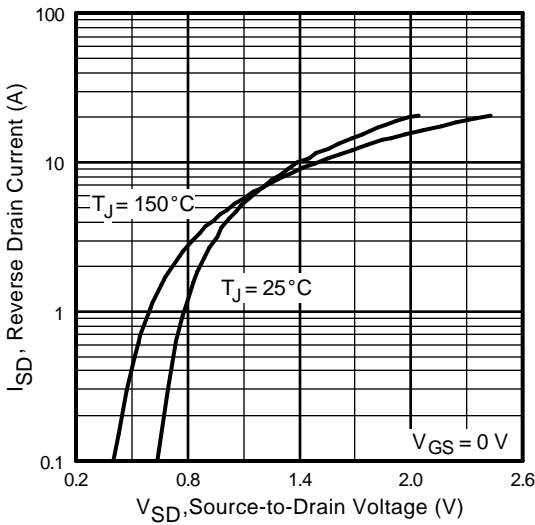
# IRLF230



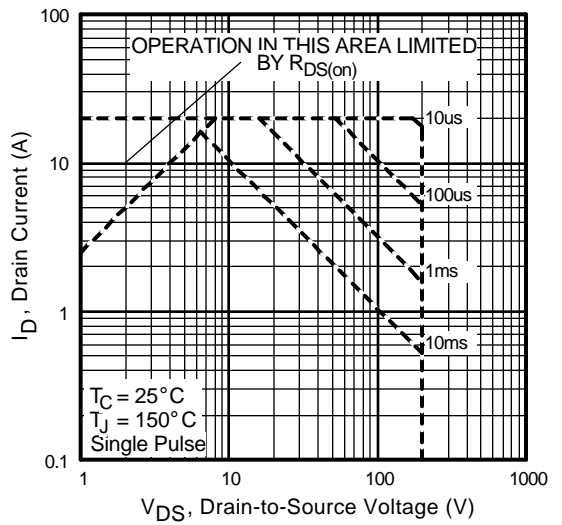
**Fig 5.** Typical Capacitance Vs. Drain-to-Source Voltage



**Fig 6.** Typical Gate Charge Vs. Gate-to-Source Voltage

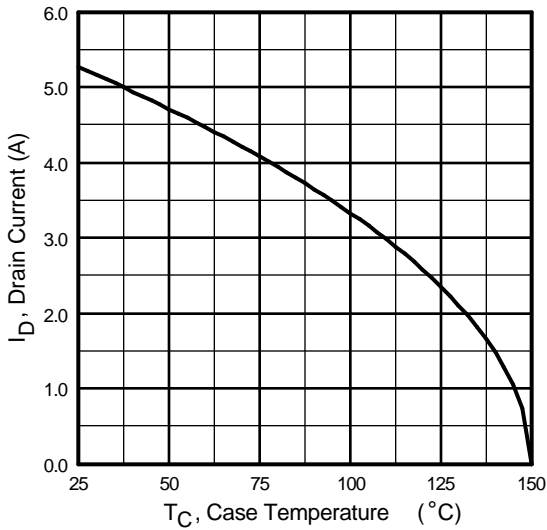


**Fig 7.** Typical Source-Drain Diode Forward Voltage

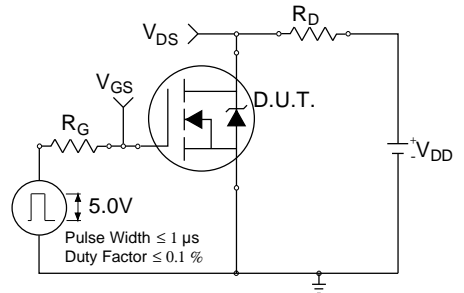


**Fig 8.** Maximum Safe Operating Area

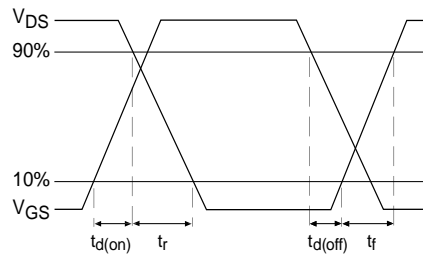
# IRLF230



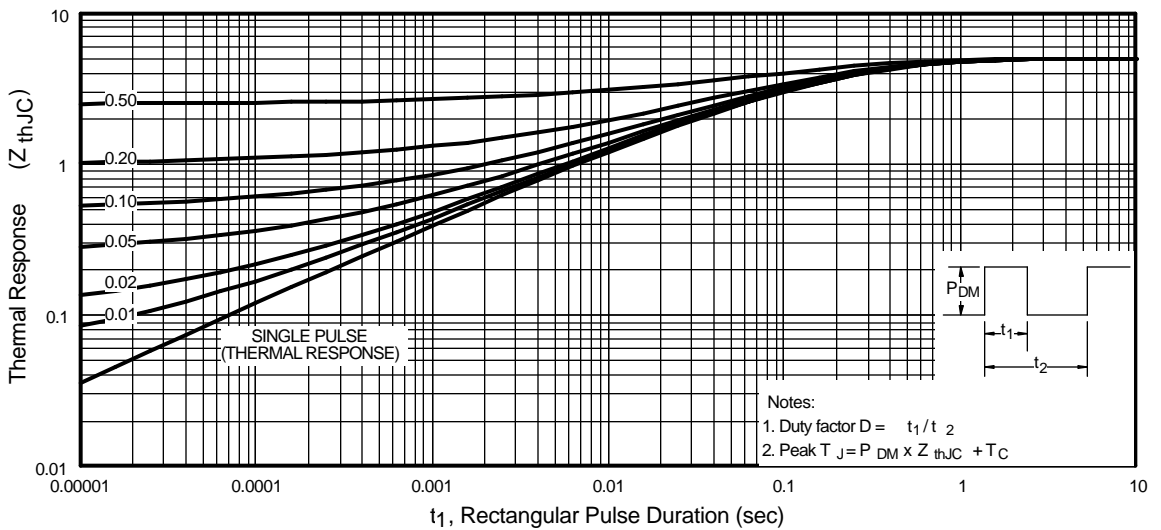
**Fig 9.** Maximum Drain Current Vs. Case Temperature



**Fig 10a.** Switching Time Test Circuit

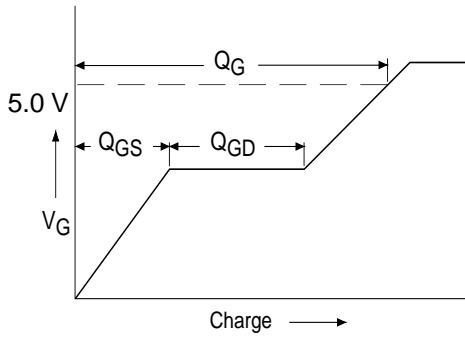


**Fig 10b.** Switching Time Waveforms

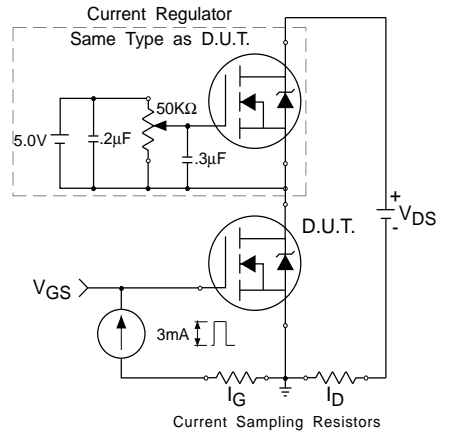


**Fig 11.** Maximum Effective Transient Thermal Impedance, Junction-to-Case

# IRLF230



**Fig 12a.** Basic Gate Charge Waveform



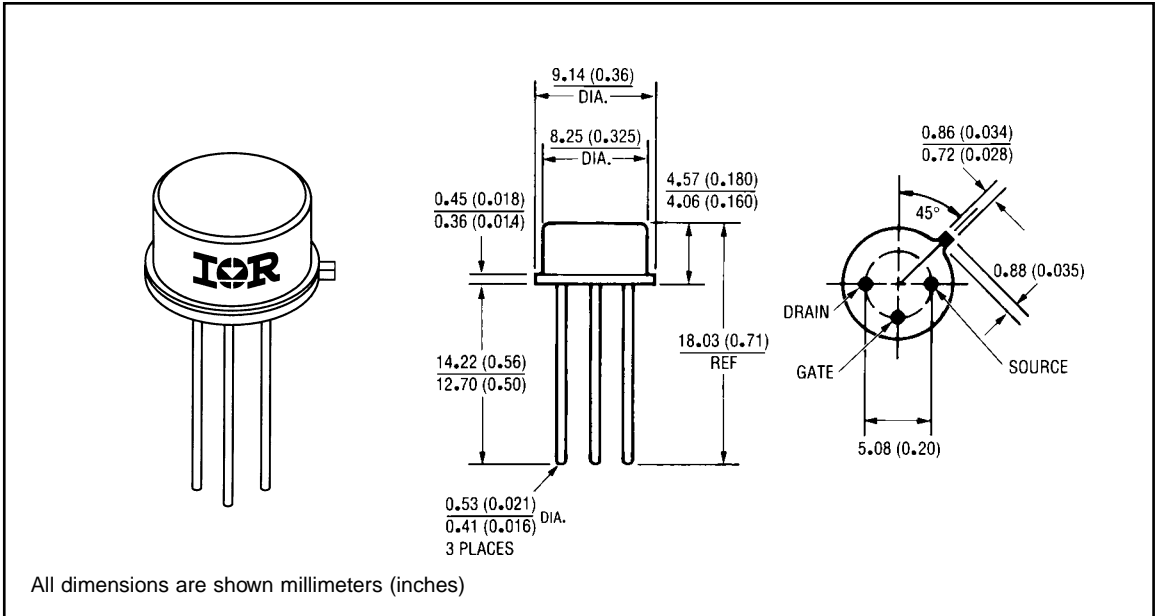
**Fig 12b.** Gate Charge Test Circuit

# IRLF230

## Notes:

- ① Repetitive Rating; Pulse width limited by maximum junction temperature.  
Refer to current HEXFET reliability report.
- ②  $K/W = ^\circ C/W$
- ③  $I_{SD} \leq 5.2A$ ,  $di/dt \leq 270 A/\mu s$ ,  
 $V_{DD} \leq BVD_{SS}$ ,  $T_J \leq 150^\circ C$   
Suggested  $R_G = 2.35\Omega$
- ④ Pulse width  $\leq 300 \mu s$ ; Duty Cycle  $\leq 2\%$

## Case Outline and Dimensions — TO-205AF (Modified TO-39)



International  
**IR** Rectifier

**WORLD HEADQUARTERS:** 233 Kansas St., El Segundo, California 90245, Tel: (310) 322 3331  
**EUROPEAN HEADQUARTERS:** Hurst Green, Oxted, Surrey RH8 9BB, UK Tel: ++ 44 1883 732020

**IR CANADA:** 7321 Victoria Park Ave., Suite 201, Markham, Ontario L3R 2Z8, Tel: (905) 475 1897

**IR GERMANY:** Saalburgstrasse 157, 61350 Bad Homburg Tel: ++ 49 6172 96590

**IR ITALY:** Via Liguria 49, 10071 Borgaro, Torino Tel: ++ 39 11 451 0111

**IR FAR EAST:** K&H Bldg., 2F, 30-4 Nishi-Ikebukuro 3-Chome, Toshima-Ku, Tokyo Japan 171 Tel: 81 3 3983 0086

**IR SOUTHEAST ASIA:** 315 Outram Road, #10-02 Tan Boon Liat Building, Singapore 0316 Tel: 65 221 8371

<http://www.irf.com/>

Data and specifications subject to change without notice.

4/97