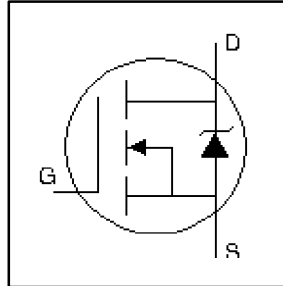


HEXFET® Power MOSFET

- Isolated Package
- High Voltage Isolation = 2.5KVRMS<sup>⑤</sup>
- Sink to Lead Creepage Dist. 4.8mm
- Logic-Level Gate Drive
- $R_{DS(ON)}$  Specified at  $V_{GS} = 4V$  &  $5V$
- Fast Switching
- Ease of paralleling



$$V_{DSS} = 200V$$

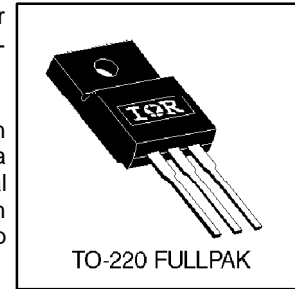
$$R_{DS(on)} = 0.40\Omega$$

$$I_D = 6.2A$$

**Description**

Third Generation HEXFETs from International Rectifier provide the designer with the best combination of fast switching, ruggedized device design, low on-resistance and cost-effectiveness.

The TO-220 Fullpak eliminates the need for additional insulating hardware in commercial-industrial applications. The moulding compound used provides a high isolation capability and a low thermal resistance between the tab and external heatsink. This isolation is equivalent to using a 100 micron mica barrier with standard TO-220 product. The Fullpak is mounted to a heatsink using a single clip or by a single screw fixing.



**Absolute Maximum Ratings**

	Parameter	Max.	Units
$I_D$ @ $T_C = 25^\circ C$	Continuous Drain Current, $V_{GS}$ @ 5.0V	6.2	A
$I_D$ @ $T_C = 100^\circ C$	Continuous Drain Current, $V_{GS}$ @ 5.0V	3.9	
$I_{DM}$	Pulsed Drain Current ①	25	
$P_D$ @ $T_C = 25^\circ C$	Power Dissipation	35	W
	Linear Derating Factor	0.28	W/ $^\circ C$
$V_{GS}$	Gate-to-Source Voltage	$\pm 10$	V
$E_{AS}$	Single Pulse Avalanche Energy ②	125	mJ
$I_{AR}$	Avalanche Current ③	6.2	A
$E_{AR}$	Repetitive Avalanche Energy ④	3.5	mJ
dv/dt	Peak Diode Recovery dv/dt ⑤	5.0	V/ns
$T_J$	Operating Junction and	-55 to + 150	$^\circ C$
$T_{STG}$	Storage Temperature Range		
	Soldering Temperature, for 10 seconds		
	Mounting torque, 6-32 or M3 screw.	10 lbf*in (1.1N*m)	

**Thermal Resistance**

	Parameter	Min.	Typ.	Max.	Units
$R_{\theta JC}$	Junction-to-Case	—	—	3.6	$^\circ C/W$
$R_{\theta JA}$	Junction-to-Ambient	—	—	65	

**Electrical Characteristics @  $T_J = 25^\circ\text{C}$  (unless otherwise specified)**

	Parameter	Min.	Typ.	Max.	Units	Conditions
$V_{(BR)DSS}$	Drain-to-Source Breakdown Voltage	200	—	—	V	$V_{GS} = 0V, I_D = 250\mu A$
$\Delta V_{(BR)DSS}/\Delta T_J$	Breakdown Voltage Temp. Coefficient	—	0.27	—	V/ $^\circ\text{C}$	Reference to $25^\circ\text{C}, I_D = 1mA$
$R_{DS(ON)}$	Static Drain-to-Source On-Resistance	—	—	0.40	$\Omega$	$V_{GS} = 5.0V, I_D = 3.7A$ ④
		—	—	0.50		$V_{GS} = 4.0V, I_D = 3.1A$ ④
$V_{GS(th)}$	Gate Threshold Voltage	1.0	—	2.0	V	$V_{DS} = V_{GS}, I_D = 250\mu A$
$g_{fs}$	Forward Transconductance	4.8	—	—	S	$V_{DS} = 50V, I_D = 5.4A$
$I_{DSS}$	Drain-to-Source Leakage Current	—	—	25	$\mu A$	$V_{DS} = 200V, V_{GS} = 0V$
		—	—	250		$V_{DS} = 160V, V_{GS} = 0V, T_J = 125^\circ\text{C}$
$I_{GSS}$	Gate-to-Source Forward Leakage	—	—	100	nA	$V_{GS} = 10V$
	Gate-to-Source Reverse Leakage	—	—	-100		$V_{GS} = -10V$
$Q_g$	Total Gate Charge	—	—	40	nH	$I_D = 9.0A$ $V_{DS} = 160V$ $V_{GS} = 10V$ , See Fig. 6 and 13 ④
$Q_{gs}$	Gate-to-Source Charge	—	—	5.5		
$Q_{gd}$	Gate-to-Drain ("Miller") Charge	—	—	24		
$t_{d(on)}$	Turn-On Delay Time	—	8.0	—		
$t_r$	Rise Time	—	57	—	ns	$V_{DD} = 100V$ $I_D = 9.0A$ $R_G = 6.0\Omega$ $R_D = 11\Omega$ , See Fig. 10 ④
$t_{d(off)}$	Turn-Off Delay Time	—	38	—		
$t_f$	Fall Time	—	33	—		
$L_D$	Internal Drain Inductance	—	4.5	—		
$L_S$	Internal Source Inductance	—	7.5	—	nH	Between lead, 6mm (0.25in.) from package and center of die contact
$C_{iss}$	Input Capacitance	—	1100	—		
$C_{oss}$	Output Capacitance	—	220	—	pF	$V_{GS} = 0V$ $V_{DS} = 25V$ $f = 1.0MHz$ , See Fig. 5
$C_{rss}$	Reverse Transfer Capacitance	—	70	—		


**Source-Drain Ratings and Characteristics**

	Parameter	Min.	Typ.	Max.	Units	Conditions
$I_S$	Continuous Source Current (Body Diode)	—	—	6.2	A	MOSFET symbol showing the integral reverse p-n junction diode.
$I_{SM}$	Pulsed Source Current (Body Diode) ①	—	—	25		
$V_{SD}$	Diode Forward Voltage	—	—	2.0	V	$T_J = 25^\circ\text{C}, I_S = 6.2A, V_{GS} = 0V$ ②
$t_{rr}$	Reverse Recovery Time	—	230	350	ns	$T_J = 25^\circ\text{C}, I_F = 9.0A$
$Q_{rr}$	Reverse Recovery Charge	—	1.7	2.6	$\mu C$	$di/dt = 100A/\mu s$ ③
$t_{on}$	Forward Turn-On Time	Intrinsic turn-on time is negligible (turn-on is dominated by $L_S+L_D$ )				

**Notes:**

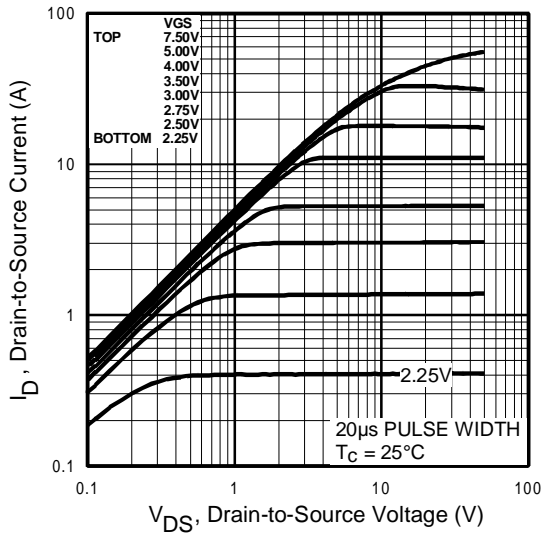
① Repetitive rating; pulse width limited by max. junction temperature. ( See fig. 11 )

②  $I_{SD} \leq 9.0A, di/dt \leq 120A/\mu s, V_{DD} \leq V_{(BR)DSS}, T_J \leq 150^\circ\text{C}$

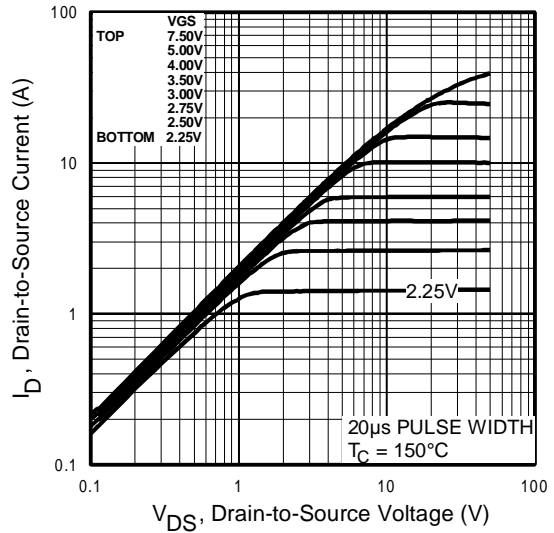
③  $t=60s, f=60Hz$

④  $V_{DD} = 25V$ , starting  $T_J = 25^\circ\text{C}$ ,  $L = 2.4mH$   
 $R_G = 25\Omega, I_{AS} = 6.2A$ . (See Figure 12)

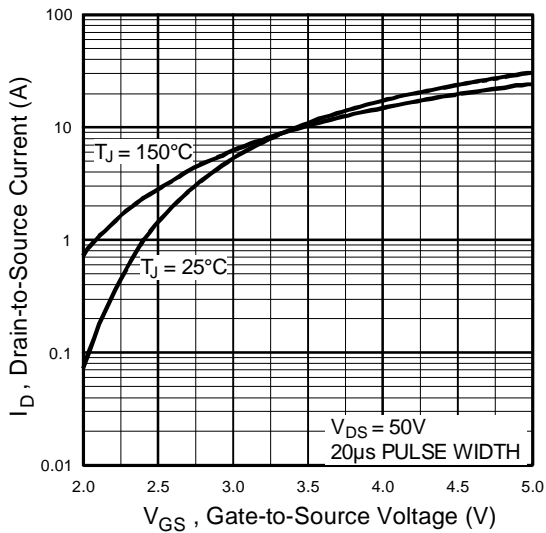
⑤ Pulse width  $\leq 300\mu s$ ; duty cycle  $\leq 2\%$ .



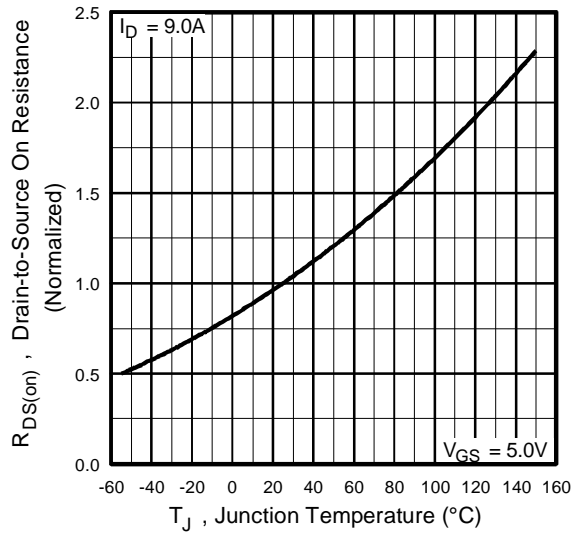
**Fig 1. Typical Output Characteristics,  $T_C = 25^\circ\text{C}$**



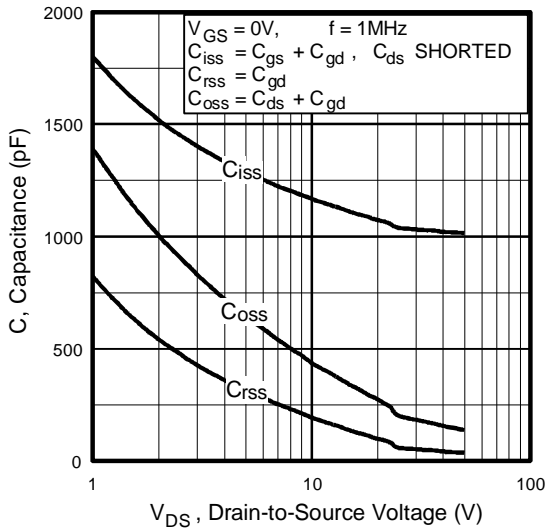
**Fig 2. Typical Output Characteristics,  $T_C = 150^\circ\text{C}$**



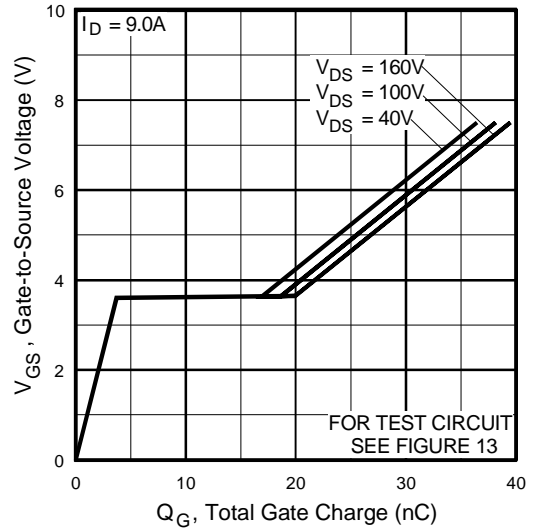
**Fig 3. Typical Transfer Characteristics**



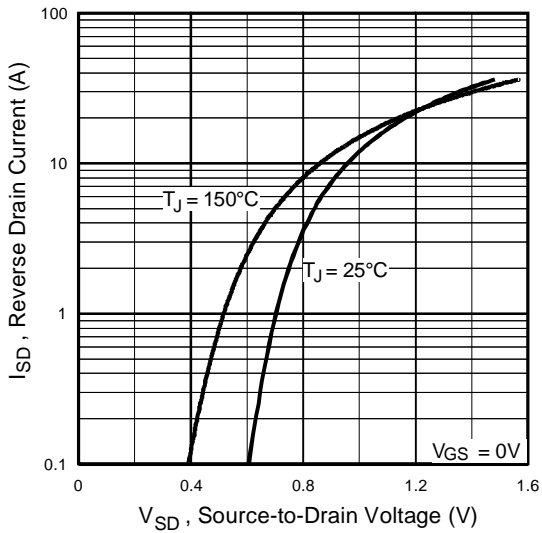
**Fig 4. Normalized On-Resistance Vs. Temperature**



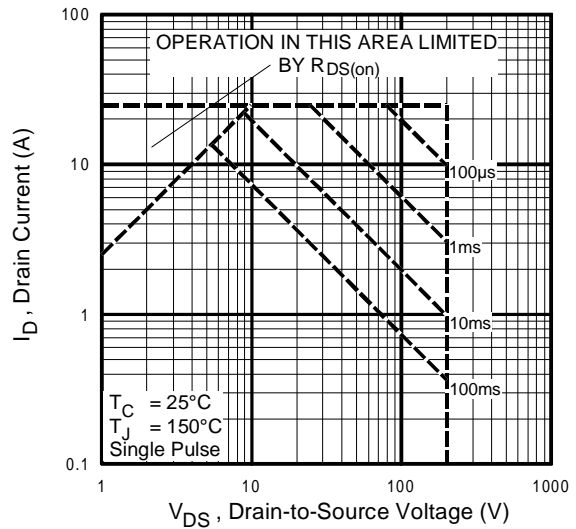
**Fig 5.** Typical Capacitance Vs. Drain-to-Source Voltage



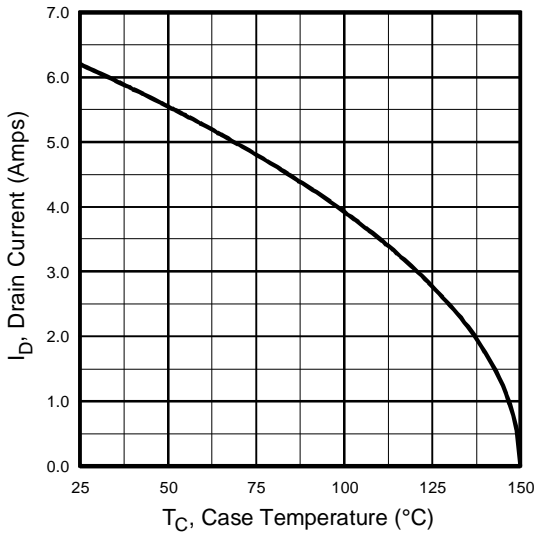
**Fig 6.** Typical Gate Charge Vs. Gate-to-Source Voltage



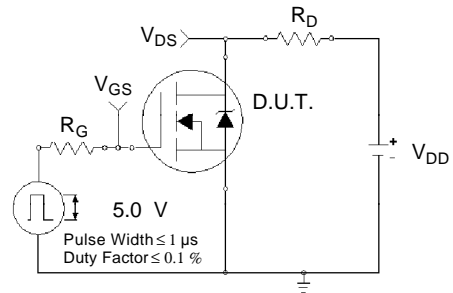
**Fig 7.** Typical Source-Drain Diode Forward Voltage



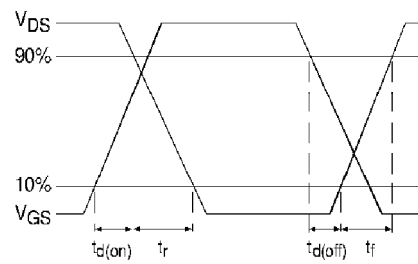
**Fig 8.** Maximum Safe Operating Area



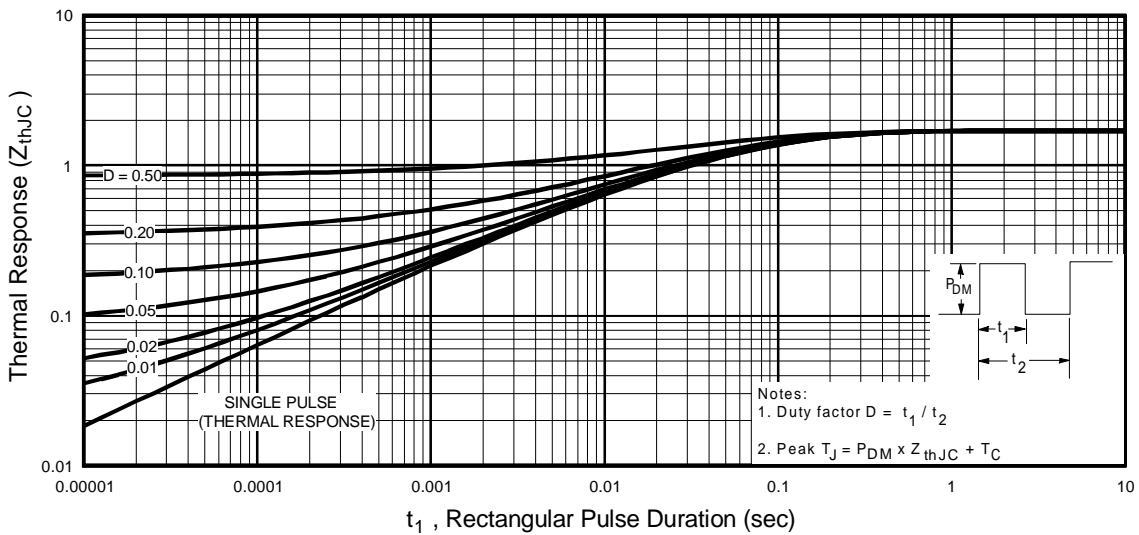
**Fig 9.** Maximum Drain Current Vs. Case Temperature



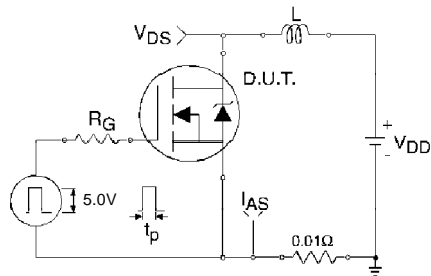
**Fig 10a.** Switching Time Test Circuit



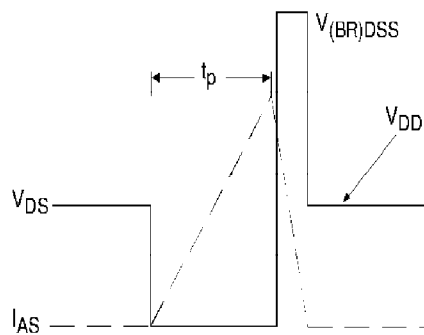
**Fig 10b.** Switching Time Waveforms



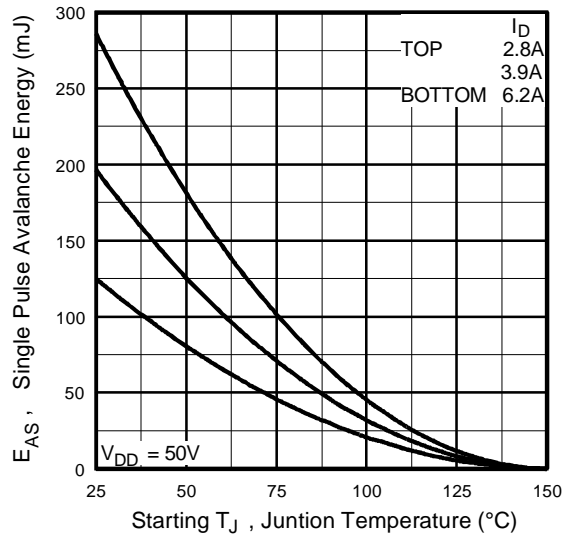
**Fig 11.** Maximum Effective Transient Thermal Impedance, Junction-to-Case



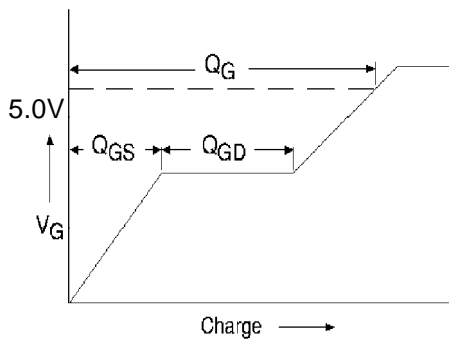
**Fig 12a.** Unclamped Inductive Test Circuit



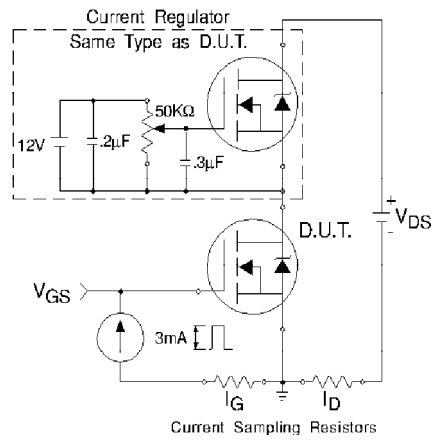
**Fig 12b.** Unclamped Inductive Waveforms



**Fig 12c.** Maximum Avalanche Energy Vs. Drain Current

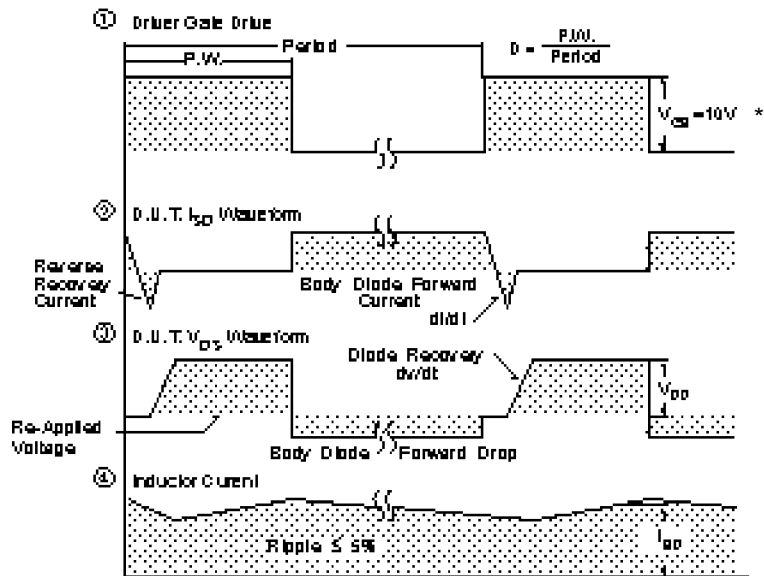
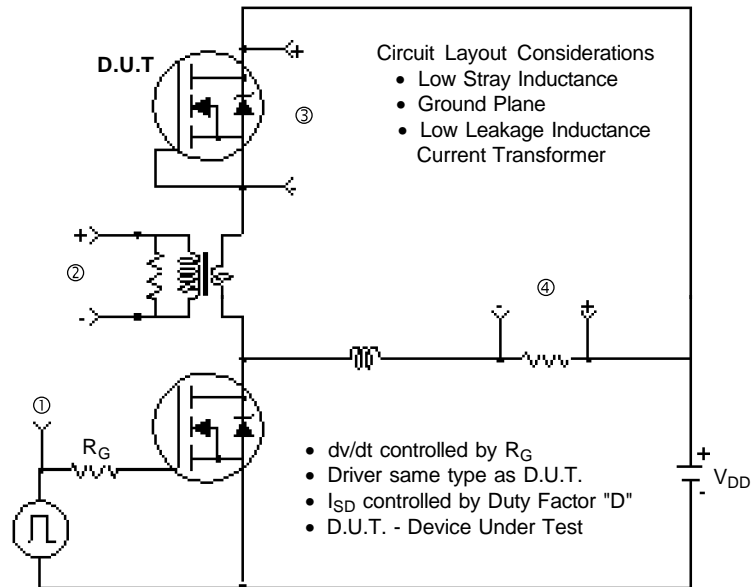


**Fig 13a.** Basic Gate Charge Waveform



**Fig 13b.** Gate Charge Test Circuit

## Peak Diode Recovery dv/dt Test Circuit



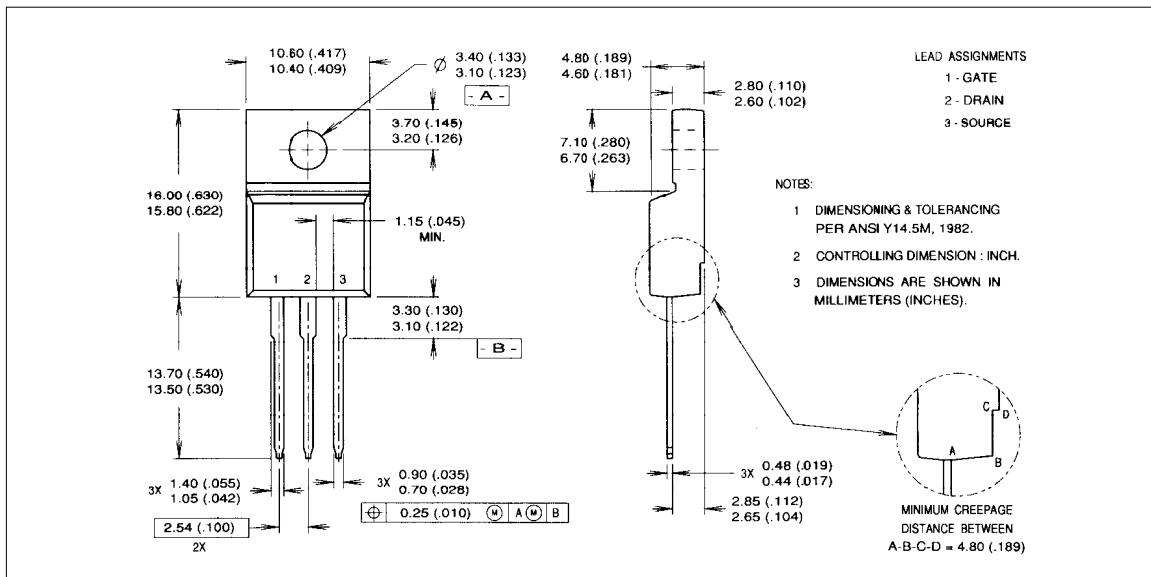
\*  $V_{GS} = 5V$  for Logic Level Devices

**Fig 14.** For N-Channel HEXFETS

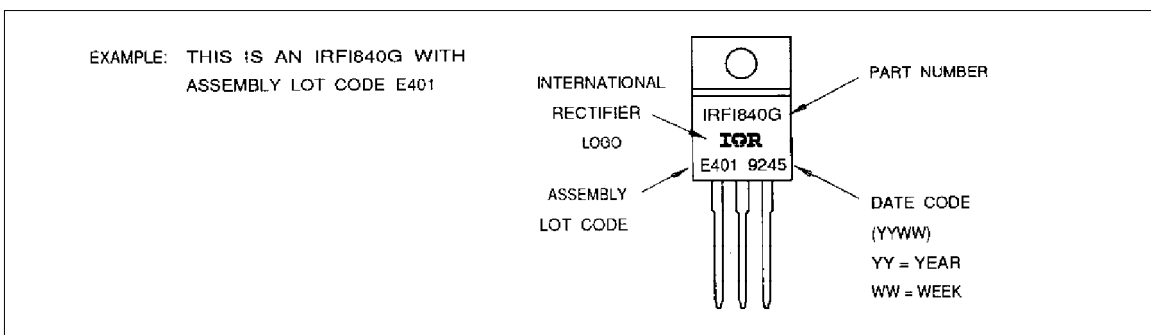
# IRLI630G



## Package Outline TO-220 Full-Pak



## Part Marking Information TO-220 Full-Pak



**WORLD HEADQUARTERS:** 233 Kansas St., El Segundo, California 90245, Tel: (310) 322 3331  
**EUROPEAN HEADQUARTERS:** Hurst Green, Oxted, Surrey RH8 9BB, UK Tel: (44) 0883 713215  
**IR CANADA:** 7321 Victoria Park Ave., Suite 201, Markham, Ontario L3R 3L1, Tel: (905) 475 1897 **IR GERMANY:** Saalburgstrasse 157, 61350 Bad Homburg Tel: 6172 37066 **IR ITALY:** Via Liguria 49, 10071 Borgaro, Torino Tel: (39) 1145 10111 **IR FAR EAST:** K&H Bldg., 2F, 3-30-4 Nishi-Ikeburo 3-Chome, Toshima-Ki, Tokyo 171 Tel: (03)3983 0641 **IR SOUTHEAST ASIA:** 315 Outram Road, #10-02 Tan Boon Liat Building, 0316 Tel: 65 221 8371

*Data and specifications subject to change without notice.*