



**TRIACS**

- GLASS PASSIVATED CHIP
- FAST-ON CONNEXIONS
- I<sub>GT</sub> SPECIFIED IN FOUR QUADRANTS
- INSULATING VOLTAGE 2500 V<sub>RM5</sub>
- UL RECOGNIZED (E81734)

**DESCRIPTION**

This new design of plastic insulated power triacs offers maximum efficiency with maximum ease of mounting.

**ADVANTAGES**

- NO TAPPING REQUIRED FOR FIXING
- EXCELLENT THERMAL IMPEDANCE AND HIGH RELIABILITY CONSTRUCTION

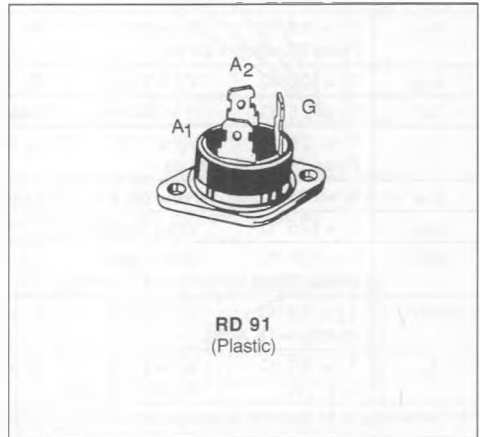

**ABSOLUTE RATINGS** (limiting values)

Symbol	Parameter	Value	Unit
I <sub>T(RMS)</sub>	RMS on-state Current (360° conduction angle) T <sub>C</sub> = 75 °C	40	A
I <sub>TSM</sub>	Non Repetitive Surge Peak on-state Current (T <sub>j</sub> initial = 25 °C - Half sine wave)	t = 8.3 ms	315
		t = 10 ms	300
i <sup>2</sup> t	i <sup>2</sup> t Value for Fusing t = 10 ms	450	A <sup>2</sup> s
di/dt	Critical Rate of Rise of on-state Current (1)	Repetitive F = 50 Hz	10
		Non Repetitive	50
T <sub>stg</sub> T <sub>I</sub>	Storage and Operating Junction Temperature Range	- 40 to 125 - 40 to 125	°C °C

Symbol	Parameter	BTA 40-					Unit
		200B	400B	600B	700B	800B	
V <sub>DRM</sub>	Repetitive Peak off-state Voltage (2)	200	400	600	700	800	V

(1) I<sub>G</sub> = 1 A di<sub>G</sub>/dt = 1 A/μs  
(2) T<sub>j</sub> = 125 °C.

**THERMAL RESISTANCES**

Symbol	Parameter	Value	Unit
R <sub>th (c-h)</sub>	Contact (case-heatsink) with Grease	0.15	°C/W
R <sub>th (j-c) DC</sub>	Junction to Case for DC	1.2	°C/W
R <sub>th (j-c) AC</sub>	Junction to Case for 360 ° Conduction Angle (F = 50 Hz)	0.9	°C/W

**GATE CHARACTERISTICS** (maximum values)

$P_{GM} = 40 \text{ W}$  ( $t_p = 10 \mu\text{s}$ )

$P_{G(AV)} = 1 \text{ W}$

$I_{GM} = 10 \text{ A}$  ( $t_p = 10 \mu\text{s}$ )

$V_{GM} = 16 \text{ V}$  ( $t_p = 10 \mu\text{s}$ )

**ELECTRICAL CHARACTERISTICS**

Symbol	Test Conditions			Quadrants	Min.	Typ.	Max.	Unit
$I_{GT}$	$T_j = 25 \text{ }^\circ\text{C}$ Pulse Duration > 20 $\mu\text{s}$	$V_D = 12 \text{ V}$	$R_L = 33 \text{ } \Omega$	I-II-III	1		50	mA
				IV	1		100	
$V_{GT}$	$T_j = 25 \text{ }^\circ\text{C}$ Pulse Duration > 20 $\mu\text{s}$	$V_D = 12 \text{ V}$	$R_L = 33 \text{ } \Omega$	I-II-III-IV			1.5	V
$V_{GD}$	$T_j = 125 \text{ }^\circ\text{C}$	$V_D = V_{DRM}$	$R_L = 3.3 \text{ k}\Omega$	I-II-III-IV	0.2			V
$I_{H^*}$	$T_j = 25 \text{ }^\circ\text{C}$	$I_T = 500 \text{ mA}$	Gate Open			30	80	mA
$I_L$	$T_j = 25 \text{ }^\circ\text{C}$ Pulse Duration > 20 $\mu\text{s}$	$V_D = 12 \text{ V}$	$I_G = 200 \text{ mA}$	I-II-III-IV			100	mA
$V_{TM}^*$	$T_j = 25 \text{ }^\circ\text{C}$	$I_{TM} = 60 \text{ A}$	$t_p = 10 \text{ ms}$				1.8	V
$I_{DRM}^*$	$T_j = 125 \text{ }^\circ\text{C}$	$V_{DRM}$ Specified				1.5	6	mA
$dv/dt^*$	$T_j = 125 \text{ }^\circ\text{C}$	Gate Open	Linear Slope up to $V_D = 67\% V_{DRM}$		250			V/ $\mu\text{s}$
$(dv/dt)_c^*$	$T_C = 75 \text{ }^\circ\text{C}$	$V_D = V_{DRM}$	$I_T = 60 \text{ A}$		5			V/ $\mu\text{s}$
$t_{gt}$	$T_j = 25 \text{ }^\circ\text{C}$	$V_D = V_{DRM}$	$I_T = 60 \text{ A}$	I-II-III-IV		2.5		$\mu\text{s}$
	$I_G = 1 \text{ A}$	$di_G/dt = 10 \text{ A}/\mu\text{s}$						

\* For either polarity of electrode A<sub>2</sub> voltage with reference to electrode A<sub>1</sub>.

**PACKAGE MECHANICAL DATA : RD 91 Plastic**

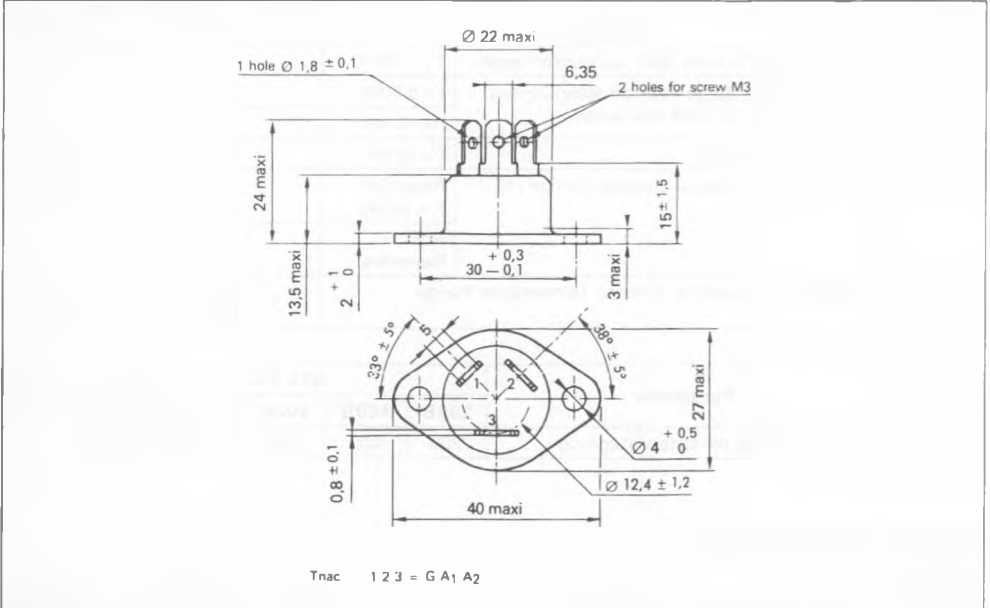

Cooling method : by conduction (method C)

Marking : type number

Weight : 15 g

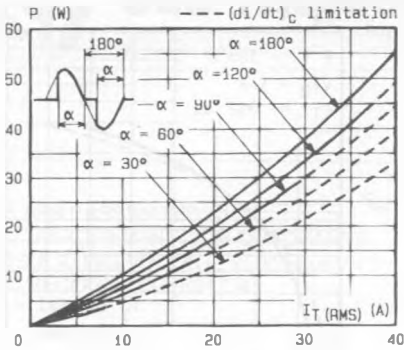

Fig. 1 - Maximum mean power dissipation versus RMS on-state current ( $F = 60 \text{ Hz}$ ).

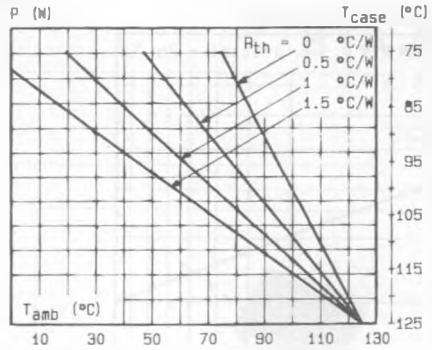

Fig. 2 - Correlation between maximum mean power dissipation and maximum allowable temperatures ( $T_{amb}$  and  $T_{case}$ ) for different thermal resistances heatsink + contact.

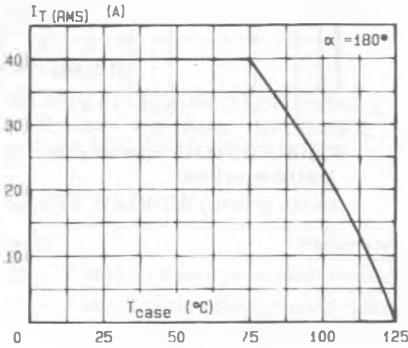

Fig. 3 - RMS on-state current versus case temperature.

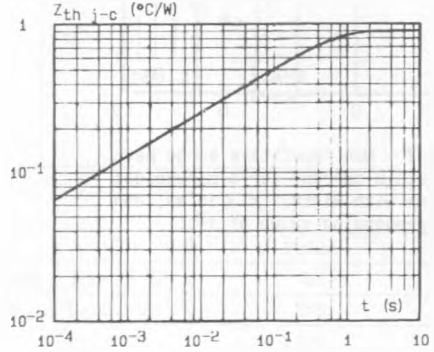

Fig. 4 - Thermal transient impedance junction to case versus pulse duration.

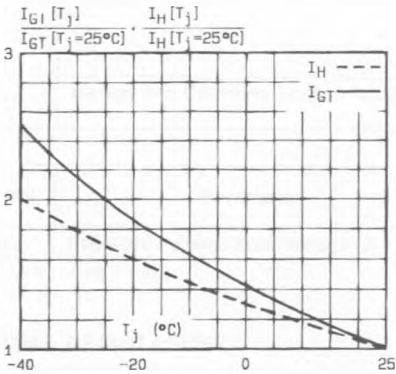

Fig. 5 - Relative variation of gate trigger current and holding current versus junction temperature.

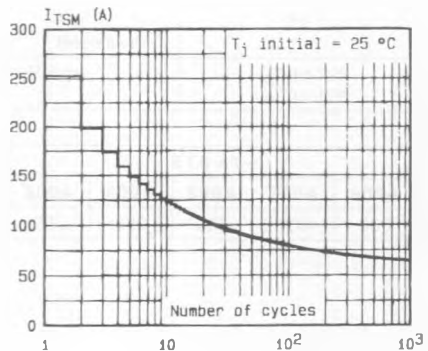

Fig. 6 - Non repetitive surge peak on-state current versus number of cycles.

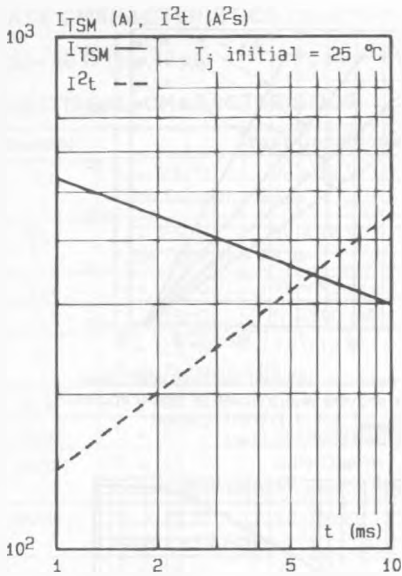

Fig.7 - Non repetitive surge peak on-state current for a sinusoidal pulse with width :  $t \leq 10$  ms, and corresponding value of  $I^2t$ .

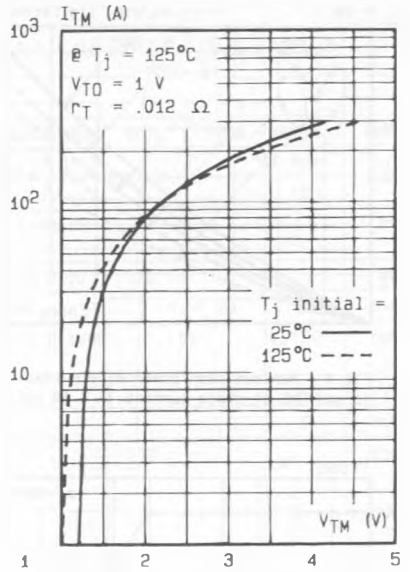

Fig.8 - On-state characteristics (maximum values).