

THYRISTORS

- GLASS PASSIVATED CHIP
- HIGH STABILITY AND RELIABILITY

DESCRIPTION

General purpose SCR suited for power supplies up to 400 Hz on resistive or inductive loads.

Thread : 1/4" -28 UNF : type N^{*}
 M6 on request : type N^{*} + suffix M



TO 48
(Metal)

ABSOLUTE RATINGS (limiting values)

Symbol	Parameter		Value	Unit
$I_{T(RMS)}$	RMS on-state Current (1)	$T_c = 70\text{ }^\circ\text{C}$	25	A
$I_{T(AV)}$	Mean on-state Current (1)	$T_c = 70\text{ }^\circ\text{C}$	16	A
I_{TSM}	Non Repetitive Surge Peak on-state Current (T_j initial $\leq 125\text{ }^\circ\text{C}$) (2)	$t = 8.3\text{ ms}$	210	A
		$t = 10\text{ ms}$	200	
I^2t	I^2t Value for Fusing	$t = 10\text{ ms}$	200	A ² s
di/dt	Critical Rate of Rise of on-state Current (3)		100	A/ μ s
T_{stg} T_j	Storage and Operating Junction Temperature Range		- 65 to 150	$^\circ\text{C}$
			- 65 to 125	$^\circ\text{C}$

Symbol	Parameter	2N681	2N682	2N683	2N685	2N687	2N688	2N689	2N690	2N691	2N692	Unit
V_{DRM} V_{RRM}	Repetitive Peak off-state Voltage (4)	25	50	100	200	300	400	500	600	700	800	V

(1) Single phase circuit, 180° conduction angle

(2) Half sine wave

(3) $I_G = 0.4\text{ A}$ $di_c/dt = 1\text{ A}/\mu\text{s}$.

(4) $T_j = 125\text{ }^\circ\text{C}$.

THERMAL RESISTANCES

Symbol	Parameter	Value	Unit
$R_{th(j-c)}$	Junction-case for D.C.	1.7	$^\circ\text{C}/\text{W}$
$R_{th(c-h)}$	Contact (case to heatsink)	0.4	$^\circ\text{C}/\text{W}$

GATE CHARACTERISTICS (maximum values)

$P_{GM} = 5 \text{ W}$ ($t_p = 100 \mu\text{s}$)

$I_{FGM} = 2 \text{ A}$ ($t_p = 100 \mu\text{s}$)

$V_{RGM} = 5 \text{ V}$

$P_{G(AV)} = 1 \text{ W}$

$V_{FGM} = 10 \text{ V}$ ($t_p = 100 \mu\text{s}$)

ELECTRICAL CHARACTERISTICS

Symbol	Test Conditions			Min.	Typ.	Max.	Unit
I_{GT}	$T_j = 25 \text{ }^\circ\text{C}$ Pulse Duration $> 20 \mu\text{s}$	$V_D = 12 \text{ V}$	$R_L = 33 \Omega$		30	40	mA
V_{GT}	$T_j = 25 \text{ }^\circ\text{C}$ Pulse Duration $> 20 \mu\text{s}$	$V_D = 12 \text{ V}$	$R_L = 33 \Omega$			1.5	V
V_{GD}	$T_j = 125 \text{ }^\circ\text{C}$	$V_D = V_{DRM}$	$R_L = 3.3 \text{ k}\Omega$	0.25			V
I_H	$T_j = 25 \text{ }^\circ\text{C}$	$I_T = 0.5 \text{ A}$	Gate Open		20		mA
I_L	$T_j = 25 \text{ }^\circ\text{C}$ Pulse Duration $> 20 \mu\text{s}$	$V_D = 12 \text{ V}$	$I_G = 80 \text{ mA}$		40		mA
V_{TM}	$T_j = 25 \text{ }^\circ\text{C}$	$I_{TM} = 50 \text{ A}$	$t_p = 10 \text{ ms}$			2	V
I_{DRM}	V_{DRM} Specified			$T_j = 25 \text{ }^\circ\text{C}$		0.02	mA
				$T_j = 125 \text{ }^\circ\text{C}$		3	
I_{RRM}	V_{RRM} Specified			$T_j = 25 \text{ }^\circ\text{C}$		0.02	mA
				$T_j = 125 \text{ }^\circ\text{C}$		3	
t_{gt}	$T_j = 25 \text{ }^\circ\text{C}$ $I_G = 200 \text{ mA}$	$V_D = V_{DRM}$ $di_G/dt = 2 \text{ A}/\mu\text{s}$	$I_T = 50 \text{ A}$		2		μs
t_d	$T_j = 125 \text{ }^\circ\text{C}$ $V_D = 67 \% V_{DRM}$ Gate Open	$I_T = 50 \text{ A}$ $di/dt = 30 \text{ A}/\mu\text{s}$	$V_R = 50 \text{ V}$ $dv/dt = 20 \text{ V}/\mu\text{s}$		100		μs
dv/dt^*	$T_j = 125 \text{ }^\circ\text{C}$ Linear Slope up to $V_D = 67 \% V_{DRM}$	Gate Open		200			V/ μs

* For higher guaranteed values, please consult us.

PACKAGE MECHANICAL DATA : TO 48 Metal

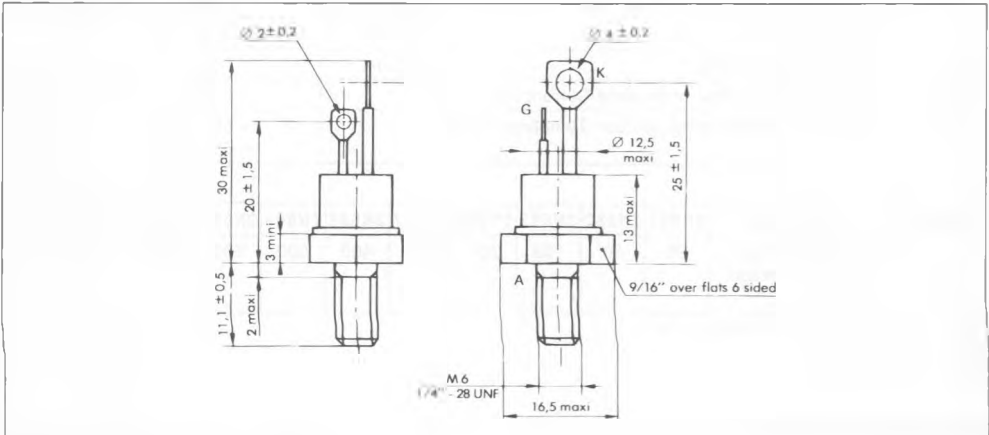

Cooling method : by conduction (method C)

Marking : type number

Weight : $13.5 \pm 1 \text{ g}$

Polarity : anode to case

Stud torque : $3.5 \text{ mAN min} - 3.8 \text{ mAN max}$

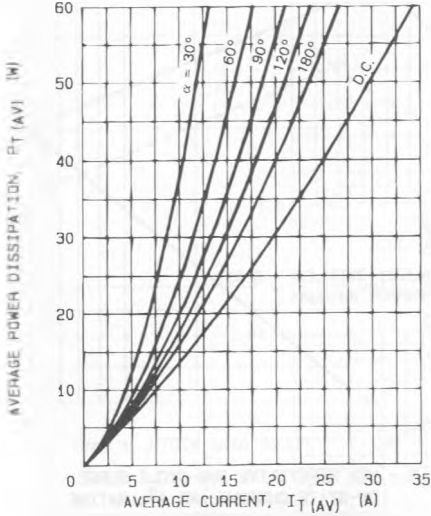
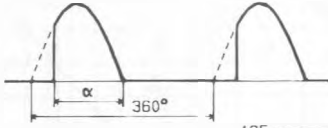

FIG. 1 - MAXIMUM ON-STATE POWER DISSIPATION FOR SINUSOIDAL CURRENT WAVEFORM

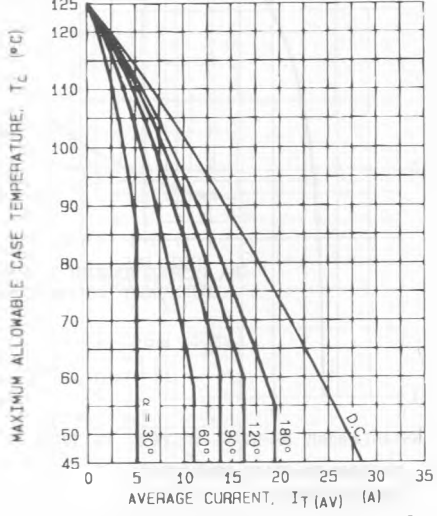

FIG. 2 - MAXIMUM ALLOWABLE CASE TEMPERATURE FOR SINUSOIDAL CURRENT WAVEFORM

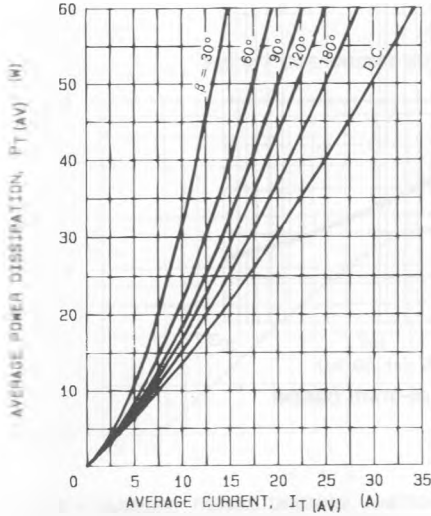
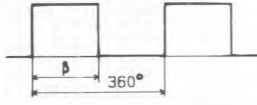

FIG. 3 - MAXIMUM ON-STATE POWER DISSIPATION FOR RECTANGULAR CURRENT WAVEFORM

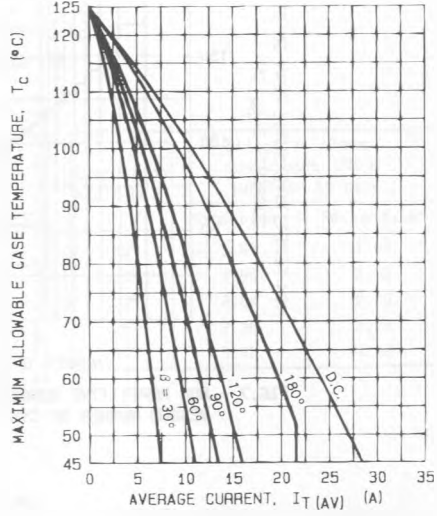

FIG. 4 - MAXIMUM ALLOWABLE CASE TEMPERATURE FOR RECTANGULAR CURRENT WAVEFORM

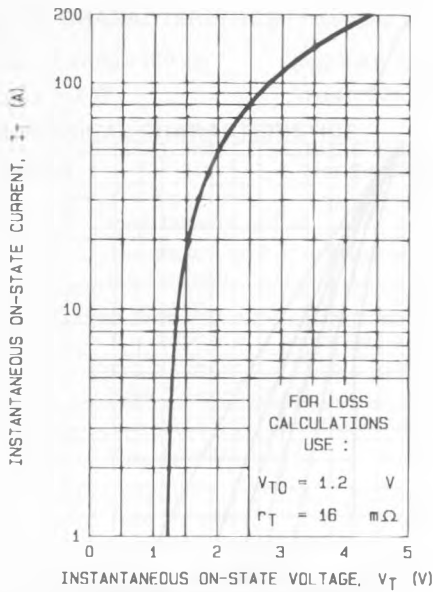

FIG. 6 - MAXIMUM ON-STATE CONDUCTION CHARACTERISTIC ($T_J = 125^\circ\text{C}$).

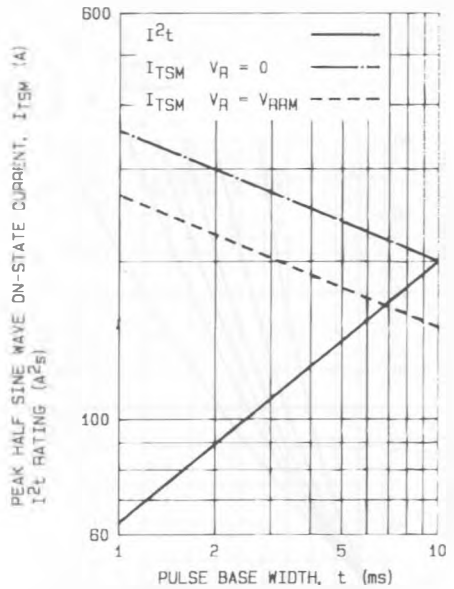

FIG. 8 - NON REPETITIVE SUB-CYCLE SURGE ON-STATE CURRENT AND I^2t RATING (INITIAL $T_J = 125^\circ\text{C}$).

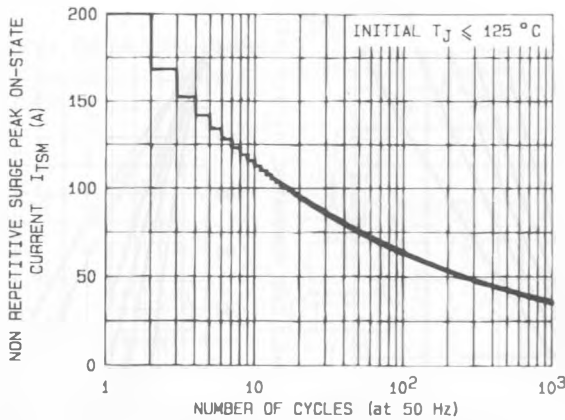

FIG. 7 - NON REPETITIVE SURGE PEAK ON-STATE CURRENT VERSUS NUMBER OF CYCLES.

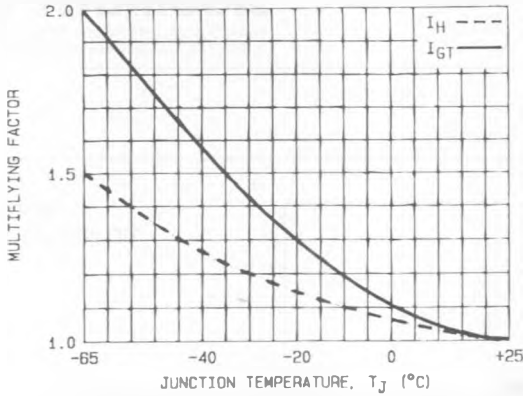

FIG.8 - RELATIVE VARIATION OF GATE TRIGGER CURRENT AND HOLDING CURRENT VERSUS JUNCTION TEMPERATURE.

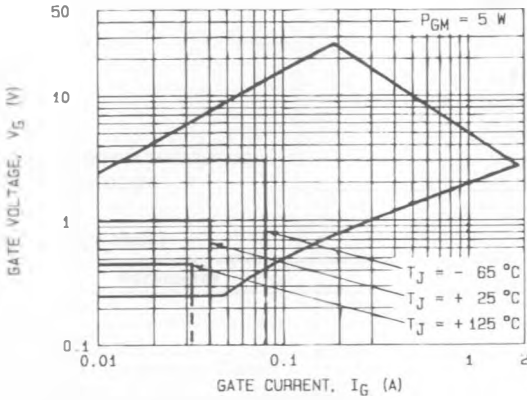
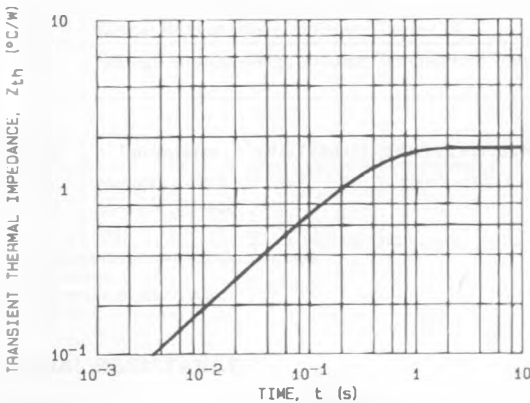

FIG.9 - GATE TRIGGER CHARACTERISTICS.



Conduction angle (α, β)	Effective thermal resistance ($^{\circ}\text{C}/\text{W}$) junction to case	
	Sinusoidal	Rectangular
180°	1.84	1.80
120°	1.90	2.55
90°	2.04	2.89
60°	2.38	3.23
30°	3.06	4.08

FIG.10 - TRANSIENT THERMAL IMPEDANCE JUNCTION TO CASE.