

$V_{DSM}$	=	1400 V
$I_{TAVM}$	=	1960 A
$I_{TRMS}$	=	3080 A
$I_{TSM}$	=	25000 A
$V_{T0}$	=	0.75 V
$r_T$	=	0.157 m $\Omega$

## Phase Control Thyristor

# 5STP 21F1400

Doc. No. 5SYA1023-04 Jan. 02

- Patented free-floating silicon technology
- Low on-state and switching losses
- Designed for traction, energy and industrial applications
- Optimum power handling capability

### Blocking

Maximum rated values <sup>1)</sup>

Symbol	Conditions	5STP 21F1400	5STP 21F1200	5STP 21F0800
$V_{DRM}, V_{RRM}$	f = 50 Hz, $t_p = 10$ ms	1400 V	1200 V	800 V
$V_{RSM}$	$t_p = 5$ ms, single pulse	1600 V	1400 V	1000 V
$dV/dt_{crit}$	Exp. to $0.67 \times V_{DRM}, T_{vj} = 125^\circ\text{C}$	200 V/ $\mu\text{s}$		

Characteristic values

Parameter	Symbol	Conditions	min	typ	max	Unit
Forward leakage current	$I_{DRM}$	$V_{DRM}, T_{vj} = 125^\circ\text{C}$			200	mA
Reverse leakage current	$I_{RRM}$	$V_{RRM}, T_{vj} = 125^\circ\text{C}$			200	mA

### Mechanical data

Maximum rated values <sup>1)</sup>

Parameter	Symbol	Conditions	min	typ	max	Unit
Mounting force	$F_M$		14	22	24	kN
Acceleration	a	Device unclamped			50	m/s <sup>2</sup>
Acceleration	a	Device clamped			100	m/s <sup>2</sup>

Characteristic values

Parameter	Symbol	Conditions	min	typ	max	Unit
Weight	m			0.6		kg
Surface creepage distance	$D_s$		25			mm
Air strike distance	$D_a$		14			mm

1) Maximum rated values are those values beyond which damage to the device may occur

ABB Switzerland Ltd, Semiconductors reserves the right to change specifications without notice.



## On-state

Maximum rated values <sup>1)</sup>

Parameter	Symbol	Conditions	min	typ	max	Unit
Average on-state current	$I_{TAVM}$	Half sine wave, $T_c = 70^\circ\text{C}$			1960	A
RMS on-state current	$I_{TRMS}$				3080	A
Peak non-repetitive surge current	$I_{TSM}$	$t_p = 10\text{ ms}$ , $T_{vj} = 125^\circ\text{C}$ , $V_D = V_R = 0\text{ V}$			25000	A
Limiting load integral	$I^2t$				3125	$\text{kA}^2\text{s}$
Peak non-repetitive surge current	$I_{TSM}$	$t_p = 8.3\text{ ms}$ , $T_{vj} = 125^\circ\text{C}$ , $V_D = V_R = 0\text{ V}$			26000	A
Limiting load integral	$I^2t$				2805	$\text{kA}^2\text{s}$

### Characteristic values

Parameter	Symbol	Conditions	min	typ	max	Unit
On-state voltage	$V_T$	$I_T = 3000\text{ A}$ , $T_{vj} = 125^\circ\text{C}$			1.22	V
Threshold voltage	$V_{T0}$	$I_T = 1000\text{ A} - 3000\text{ A}$ , $T_{vj} = 125^\circ\text{C}$			0.75	V
Slope resistance	$r_T$				0.157	$\text{m}\Omega$
Holding current	$I_H$	$T_{vj} = 25^\circ\text{C}$			70	mA
		$T_{vj} = 125^\circ\text{C}$			60	mA
Latching current	$I_L$	$T_{vj} = 25^\circ\text{C}$			350	mA
		$T_{vj} = 125^\circ\text{C}$			120	mA

## Switching

Maximum rated values <sup>1)</sup>

Parameter	Symbol	Conditions	min	typ	max	Unit
Critical rate of rise of on-state current	$di/dt_{crit}$	$T_{vj} = 125^\circ\text{C}$ , $I_{TRM} = 2000\text{ A}$ , $V_D \leq 0.67 V_{DRM}$ , $I_{FG} = 2\text{ A}$ , $t_r = 0.5\ \mu\text{s}$			200	$\text{A}/\mu\text{s}$
Critical rate of rise of on-state current	$di/dt_{crit}$		Cont. $f = 50\text{ Hz}$			1000
Circuit-commutated turn-off time	$t_q$	$T_{vj} = 125^\circ\text{C}$ , $I_{TRM} = 2000\text{ A}$ , $V_R = 200\text{ V}$ , $di_T/dt = -20\text{ A}/\mu\text{s}$ , $V_D \leq 0.67 \cdot V_{DRM}$ , $dV_D/dt = 20\text{ V}/\mu\text{s}$ ,	400			$\mu\text{s}$

### Characteristic values

Parameter	Symbol	Conditions	min	typ	max	Unit
Recovery charge	$Q_{rr}$	$T_{vj} = 125^\circ\text{C}$ , $I_{TRM} = 2000\text{ A}$ , $V_R = 200\text{ V}$ , $di_T/dt = -20\text{ A}/\mu\text{s}$	1800		3000	$\mu\text{As}$
Delay time	$t_d$	$V_D = 0.4 \cdot V_{DRM}$ , $I_{FG} = 2\text{ A}$ , $t_r = 0.5\ \mu\text{s}$			3	$\mu\text{s}$

## Triggering

Maximum rated values <sup>1)</sup>

Parameter	Symbol	Conditions	min	typ	max	Unit
Peak forward gate voltage	V <sub>FGM</sub>				12	V
Peak forward gate current	I <sub>FGM</sub>				10	A
Peak reverse gate voltage	V <sub>RGM</sub>				10	V
Gate power loss	P <sub>G</sub>	For DC gate current			3	W
Average gate power loss	P <sub>GAV</sub>		see Fig. 9			

Characteristic values

Parameter	Symbol	Conditions	min	typ	max	Unit
Gate trigger voltage	V <sub>GT</sub>	T <sub>vj</sub> = 25°C			2.6	V
Gate trigger current	I <sub>GT</sub>	T <sub>vj</sub> = 25°C			400	mA
Gate non-trigger voltage	V <sub>GD</sub>	V <sub>D</sub> = 0.4 x V <sub>DRM</sub> , T <sub>vjmax</sub> = 125°C	0.3			V
Gate non-trigger current	I <sub>GD</sub>	V <sub>D</sub> = 0.4 x V <sub>DRM</sub> , T <sub>vjmax</sub> = 125°C	10			mA

## Thermal

Maximum rated values <sup>1)</sup>

Parameter	Symbol	Conditions	min	typ	max	Unit
Operating junction temperature range	T <sub>vj</sub>				125	°C
Storage temperature range	T <sub>stg</sub>		-40		140	°C

Characteristic values

Parameter	Symbol	Conditions	min	typ	max	Unit
Thermal resistance junction to case	R <sub>th(j-c)</sub>	Double-side cooled			17	K/kW
	R <sub>th(j-c)A</sub>	Anode-side cooled			33	K/kW
	R <sub>th(j-c)C</sub>	Cathode-side cooled			35	K/kW
Thermal resistance case to heatsink	R <sub>th(c-h)</sub>	Double-side cooled			4	K/kW
	R <sub>th(c-h)</sub>	Single-side cooled			8	K/kW

Analytical function for transient thermal impedance:

$$Z_{thJC}(t) = \sum_{i=1}^n R_i(1 - e^{-t/\tau_i})$$

i	1	2	3	4
R <sub>i</sub> (K/kW)	10.35	3.76	2.29	0.67
τ <sub>i</sub> (s)	0.3723	0.0525	0.0057	0.0023

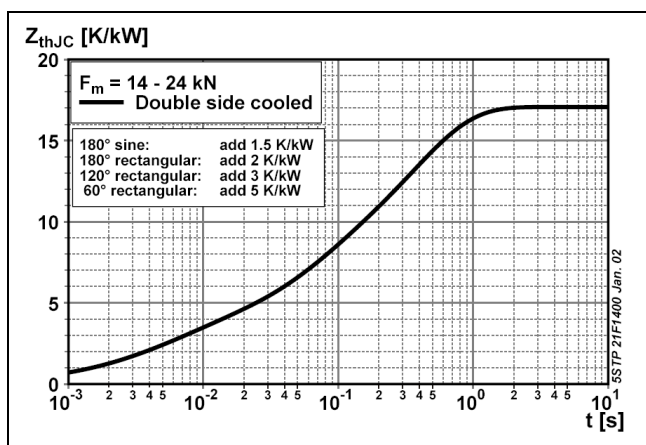

Fig. 1 Transient thermal impedance junction-to case.

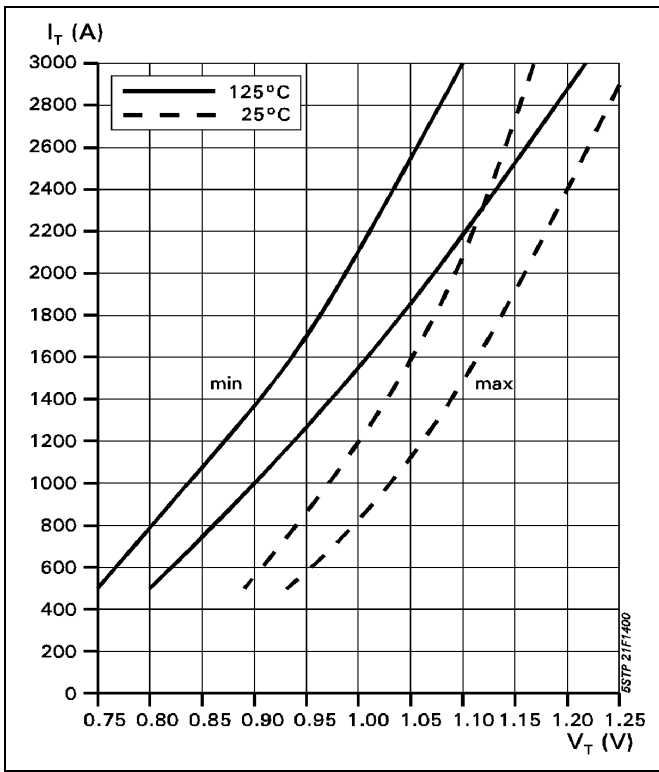

Fig. 2 On-state characteristics.

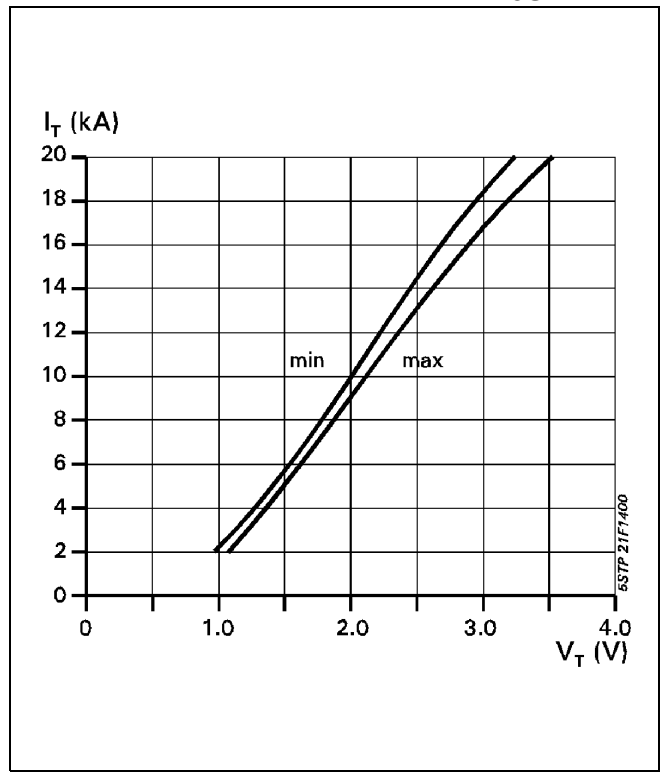

Fig. 3 On-state characteristics.  
 $T_j = 125^\circ\text{C}$ , 10ms half sine

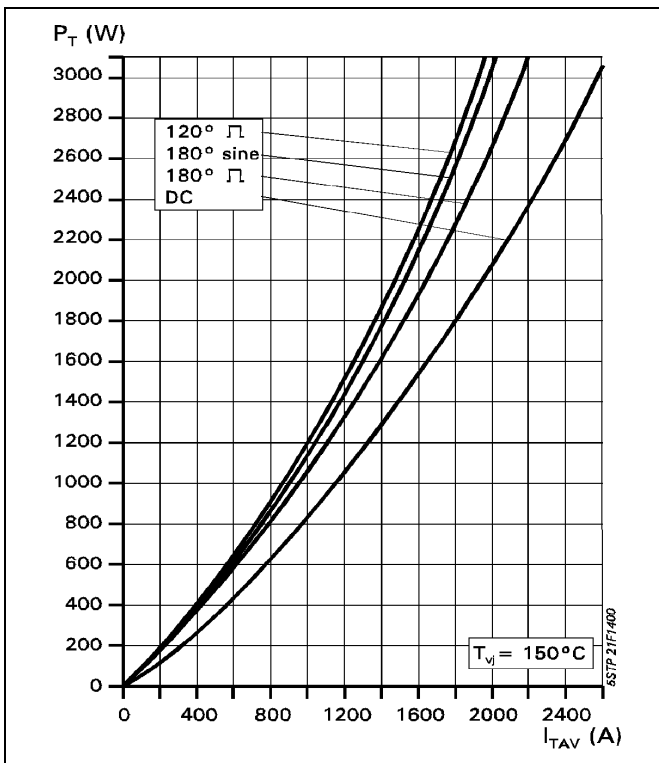

Fig. 4 On-state power dissipation vs. mean on-state current. Turn - on losses excluded.

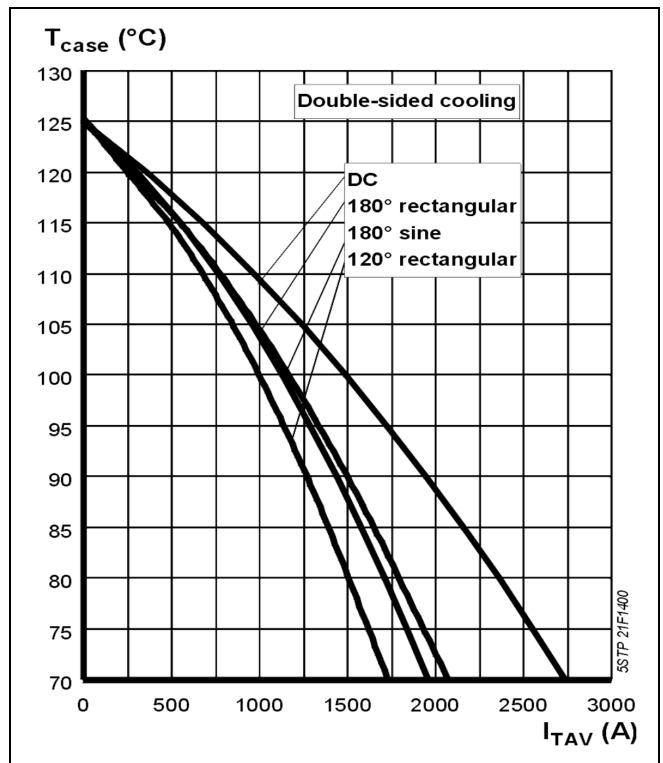

Fig. 5 Max. permissible case temperature vs. mean on-state current.

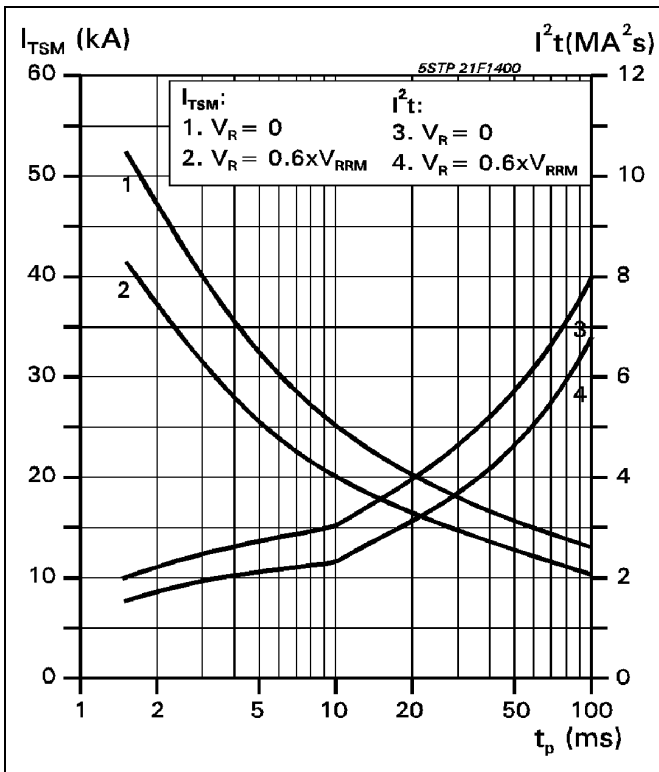

Fig. 6 Surge on-state current vs. pulse length. Half-sine wave.

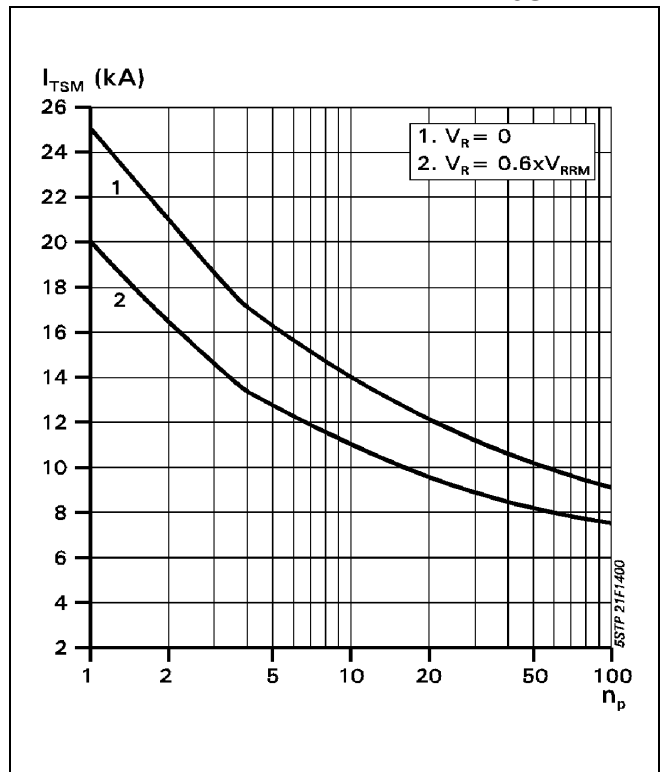

Fig. 7 Surge on-state current vs. number of pulses. Half-sine wave, 10 ms, 50Hz.

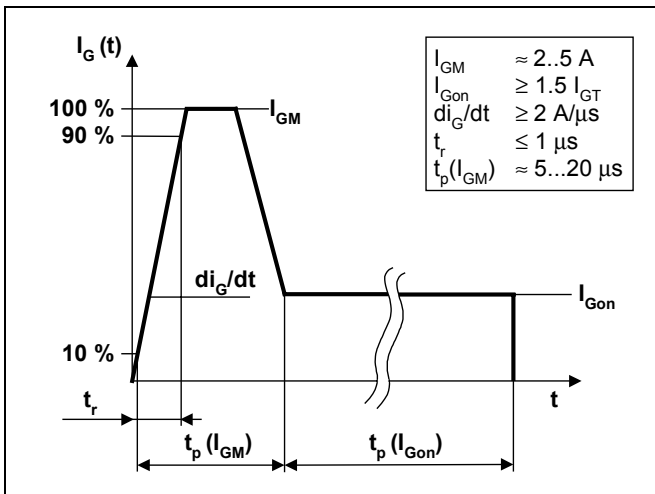

Fig. 8 Recommended gate current waveform.

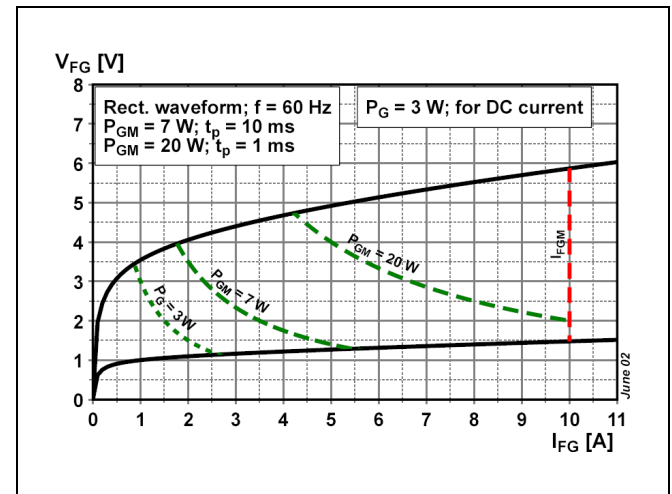

Fig. 9 Max. peak gate power loss.

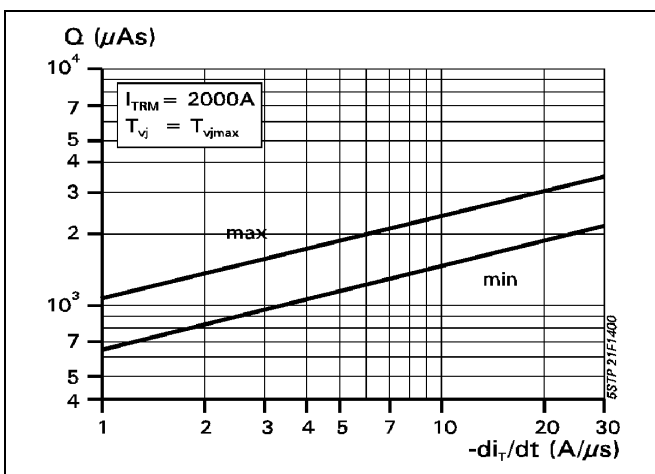

Fig. 10 Recovery charge vs. decay rate of on-state current.

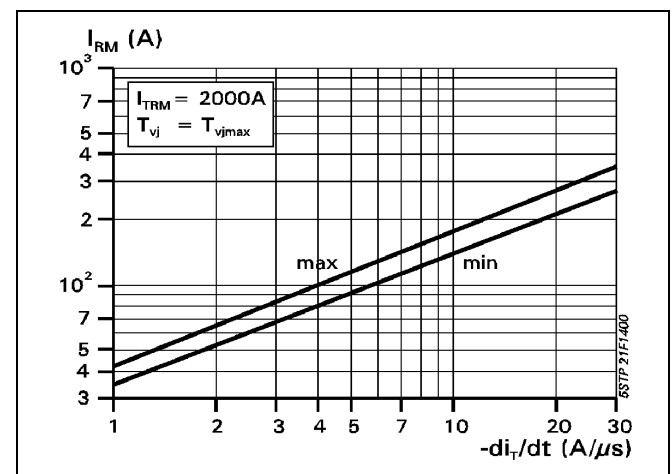

Fig. 11 Peak reverse recovery current vs. decay rate of on-state current.

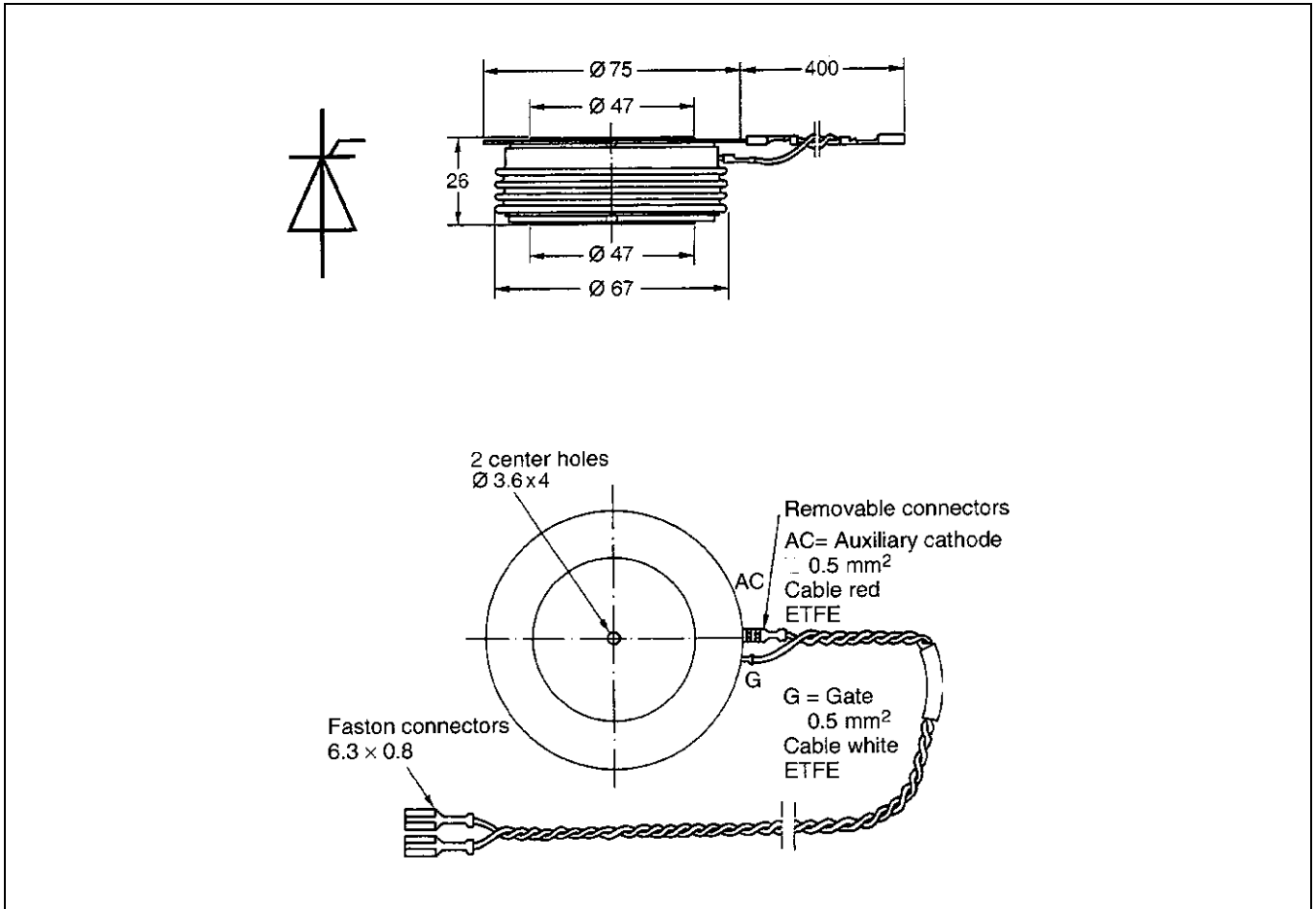

Fig. 12 Device Outline Drawing.

ABB Switzerland Ltd, Semiconductors reserves the right to change specifications without notice.

# ABB

**ABB Switzerland Ltd**  
**Semiconductors**  
 Fabrikstrasse 3  
 CH-5600 Lenzburg, Switzerland

Telephone +41 (0)58 586 1419  
 Fax +41 (0)58 586 1306  
 Email [abbsem@ch.abb.com](mailto:abbsem@ch.abb.com)  
 Internet [www.abbsem.com](http://www.abbsem.com)