

Technical Data

THYRISTOR

maximum ratings

VDRM	60.0	V	NO.	BRX45
VRRM	60.0	V	TYPE	THYRISTOR
IT (AV)	0.4	A		
IT (RMS)	0.8	A		
ITSM (tp = 10 ms)	6.0	A	CASE	SOT-54
Max. Power Dissipation (PT) at TC = °C		W		RD26
Max. Thermal Resistance (Rth J-A)	190.0	°C/W		
Max. Junction Temperature (TJ)	125.0	°C		

PERFORMANCE CHARACTERISTICS at $T_c = 25^\circ\text{C}$, unless otherwise noted

NO.	SYMBOL	CONDITIONS	MIN.	MAX.	UNITS
1.	IDRM	VDRM = 60.0 V, RGk = 1.0 k Ω	-	100.0	nA
2.	IRRM	VRRM = 60.0 V, RGk = 1.0 k Ω	-	100.0	nA
3.	IDRM	VDRM = 60.0 V, RGk = 1.0 k Ω , TJ = 125.0° C	-	50.0	μ A
4.	IRRM	VRRM = 60.0 V, RGk = 1.0 k Ω , TJ = 125.0° C	-	50.0	μ A
5.	IGT	VD = 7.0 V, RGk = 1.0 k Ω , RL = 100.0 Ω	-	200.0	μ A
6.	VGT	VD = 7.0 V, RGk = 1.0 k Ω , RL = 100.0 Ω	-	0.9	V
7.	VTM	IT = 1.0 A (1)	-	1.7	V
8.	tq	VD = 40.0 V, IT = 0.8 A, dv/dt = 20.0 V/ μ s (2)	-	8.0	μ s
9.	PG(AV)	VD = 40.0 V, IT = 0.8 A, dv/dt = 20.0 V/ μ s	-	0.1	W
10.	PGM	VD = 40.0 V, IT = 0.8 A, dv/dt = 20.0 V/ μ s	-	2.0	W
11.	I ² t	t = 10.0 ms	-	18.0	A ² s
12.					
13.					
14.					
15.					
16.					
17.					
18.	-	1 = CATHODE	0.0	0.0	-
19.	-	2 = GATE	0.0	0.0	-
20.	-	3 = ANODE	0.0	0.0	-

Notes (1)pulse-tested tp \leq 300 μ s, duty cycle \leq 2 %
(2)typical value

DIMENSIONS
in mm

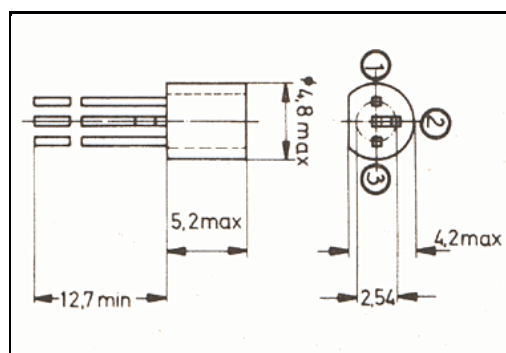

Marking BRX45
Customer GENERAL PURPOSE