

RADIOPHONE

# DJ-680

## Dealer's Manual

Alinco's radiophone DJ-680 is a cellular-look radio supporting both full- and half-duplex communications. This manual contains information the dealer should know before configuring this product. It also describes how to install Alinco's EJ-27D logic board on the radio and configure the detailed operation parameters.

# Introduction

Alinco's radiophone DJ-680 requires you (the dealer) to program the configuration parameters. You can program in three different ways.

- Running the Channel Editor software on a personal computer and transferring the programmed data to the radio (see 3 "Programming on the Channel Editor" through 9 "Checking the LCD").
- Copying data in the master radio to another radio (clone function) (see 4 "Copying Data between Two Radios (Clone Function)").
- Starting the radio in the dealer mode and programming it with the keys (see 5 "Programming in the Dealer Mode" through 7 "Setting General Radio Parameters").

The dealer's configuration includes selecting banks and channels to be used, defining communication method (duplex or simplex) for each bank, and setting frequency on each channel. If necessary, you can also program selective calling, ANI, BCLO, and TOT, to determine how the radio should transmit or receive calls.

You may need to install the optional EJ-27D logic board on the radio to equip it with trunking capabilities before configuring these parameters (see 2 "Installing the EJ-27D Logic Board").

The programmed product should be supplied to the user with a list of parameter settings to avoid confusion on the user's part. Some of the functions may be disabled by the dealer, but the DJ-680 Instruction Manual provided with the product covers all the instructions according to the functional specifications.

# Contents

<b>Introduction</b> .....	1
<b>Contents</b> .....	2
<b>1. Overview</b> .....	3
1.1 Dealer Mode.....	3
Bank Parameters.....	3
General Radio Parameters.....	3
1.2 Trunking.....	4
1.3 Bank Configuration.....	5
1.4 Operation Modes.....	5
When Equipped with the EJ-27D Logic Board.....	6
When Not Equipped with the EJ-27D Logic Board.....	7
<b>2. Installing the EJ-27D Logic Board</b> .....	8
2.1 Installing the Logic Board.....	8
2.2 Programming the Logic Board.....	9
<b>3. Programming on the Channel Editor</b> .....	10
<b>4. Copying Data between Two Radios (Clone Function)</b> .....	12
<b>5. Programming in the Dealer Mode</b> .....	13
5.1 Starting the Radio in the Dealer Mode.....	13
5.2 Entering the Password (Password Screen).....	14
5.3 Selecting the Type of Parameters (Dealer Mode Screen).....	15
<b>6. Configuring Banks (<i>Bank Select</i> Screen)</b> .....	16
6.1 Selecting a Bank to be Configured ( <i>Bank Select</i> Screen).....	16
6.2 Configuring the Selected Bank (Bank Menu).....	17
Naming the Bank.....	17
Selecting Duplex or Simplex Communication.....	19
6.3 Selecting a Channel to be Configured.....	20
6.4 Configuring the Selected Channel (Channel Menu).....	21
Setting the Frequency.....	21
Setting TSQ, Tone Encoder, and Scrambler.....	24
6.5 Turning Selective Calling ON/OFF.....	26
6.6 Clearing Bank Data.....	27
6.7 Clearing Channel Data.....	27
<b>7. Setting General Radio Parameters (<i>DTMF Burst</i> Screen)</b> .....	28
DTMF Burst Time ( <i>DTMF Burst</i> Screen).....	28
ANI Transmission Timing ( <i>ANI Send</i> Screen).....	29
ANI Code ( <i>ANI Code</i> Screen).....	29
ID Code for Selective Calling ( <i>Slct ID Code</i> Screen).....	30
Middle Code for Selective Calling ( <i>Slct Middle</i> Screen).....	30
Delay for Selective Calling ( <i>Slct Delay</i> Screen).....	30
TOT (Time Out Timer) ( <i>TOT Func.</i> Screen).....	31
BCLO (Busy Channel Lock Out) ( <i>BCLO Func.</i> Screen).....	31
Password ( <i>Password</i> Screen).....	31
Transmission Command ( <i>Send Data</i> Screen).....	32
Clone ( <i>Clone Func.</i> Screen).....	32
<b>8. Initializing the Memory</b> .....	33
<b>9. Checking the LCD</b> .....	33
<b>Appendix Quick Reference</b> .....	34

# 1. Overview

This chapter describes overview of the DJ-680 radio phone, including important terms related to radio operation: dealer mode, trunking, operation modes, and banks. You should be familiar with these terms when configuring the DJ-680.

## 1.1 Dealer Mode

The radio must be placed in the *dealer mode* when you (the dealer) want to configure it using the keys. This manual describes the operation in this mode in 5 "Programming in the Dealer Mode" through 9 "Checking the LCD." The parameters you can set in this mode are divided into two groups: *bank parameters* and *general radio parameters*.

### Bank Parameters

The bank parameters listed below can be set for each bank. For information about banks, see 1.3 "Bank Configuration."

#### Bank names

Assign a name to each bank.

#### Communication method

Select a communication method for each bank, between *duplex* and *simplex*.

#### Selective calling

Turn ON or OFF *selective calling*. This allows the user to call a specific party by specifying an ID code. This function is available in banks 4 and 5 when the radio is equipped with the logic board, and in all the banks when the radio is not equipped with the logic board.

#### Channel settings

Select channels to be used in the bank, and set the frequency for each channel. *Tone squelch*, *tone encoder* and *scrambler* are also available for channels in banks 4 and 5 when the radio is equipped with the logic board, and in all banks when the radio is not equipped with the logic board.

### General Radio Parameters

The general radio parameters include settings effective throughout radio operation. Note that when the radio is equipped with the logic board, DTMF, ANI, selective calling, TOT, and BCLO are available only in banks 4 and 5; and in all banks when the radio is not equipped with the logic board.

#### DTMF burst time

Set the duration of a DTMF tone. This value will also serve as the interval between tones.

#### ANI (Automatic Number Identification)

The ANI function allows the radio to automatically send the programmed DTMF codes just after transmission starts and/or ends. In the dealer mode, you can set the ANI code for the radio and when to send the code. Also, you have the option to disable this function.

### **Selective Calling**

The DJ-680 supports selective calling by 7-digit DTMF coding. When you enable selective calling, set the *ID code*, *middle code*, and *delay*. The radio outputs the party's ID code, a one-digit middle code, and the radio's ID code in that order at the beginning of transmission. The radio unmutes the squelch when it receives the middle code following its own code.

You may need to set the *delay time* when using selective calling if transmitting through a repeater. Generating a delay prevents the radio from outputting the DTMF code until the repeater activates.

### **TOT (Time Out Timer)**

Set the maximum transmission time.

### **BCLO (Busy Channel Lock Out)**

Enable or disable the *BCLO* function. If enabled, the radio prevents transmission on a channel which is receiving a signal with a tone other than the one for the group.

### **Password for entering the dealer mode**

You can set a *password* to prevent others from changing the dealer-configured parameters.

### **Transmission command (1 \*, 2 \*)**

Select the transmission command, 1 \* or 2 \*, used in the radio-phone mode. For information about the radio-phone mode, see "1.4 Operation Modes."

### **Clone function**

You can prohibit data to be read from the radio through the clone function.

## **1.2 Trunking**

The radio is capable of *trunking* if the EJ-27D logic board is installed in it. Trunking eliminates the need to select the channel used for communication. The radio automatically skips busy channels and searches for an available channel while calling a party. On the other hand, a party can call the user without having to know the channel to be used, because the DJ-680 radio automatically provides an available channel. If the user is in another city, the radio is to change its group of channels (called *bank*).

A trunking network consists of trunked radios only. On it, communications are selective and private, that is, conversations cannot be heard or interrupted by other trunked radios.

Without trunking, the user has to manually change the channel if it is busy. To receive a call from a telephone, the user needs to previously inform the party of the channel to be used.

The trunking system used herein is ALTRUNK which is compatible with SmarTrunk™ II. For more information about this system, see DP-2d Trunking Controller Manual and EJ-27D Logic Board Manual.

# 1.3 Bank Configuration

The term *bank* in this manual has two different meanings depending on whether or not the trunking function is working.

While trunking is activated, a bank means a service area on the trunking network where the radio can work. If the user is in another area, he/she needs to change to the bank appropriate to that area.

While trunking is NOT activated, a bank refers to a group of channels.



*Note: A bank is called site in the DJ-680 Instruction Manual supplied with the radio.*

The radio supports five banks (banks 1 through 5). You can configure up to 3 banks (banks 1 to 3) for duplex or simplex communications. Banks 4 and 5 are dedicated for use in simplex communication. If you do not set any parameters for a given bank, the radio will ignore the bank while the user operates the radio.

Banks 1 through 3 contain 20 channels per bank, however, not more than 16 channels are networked at any one time (the number of actually usable channels is user-transparent). Banks 4 and 5 each contain 10 channels maximum.

The dealer assigns a unique name to each bank. The user will identify each bank by its bank name while operating the radio.

### Bank configuration

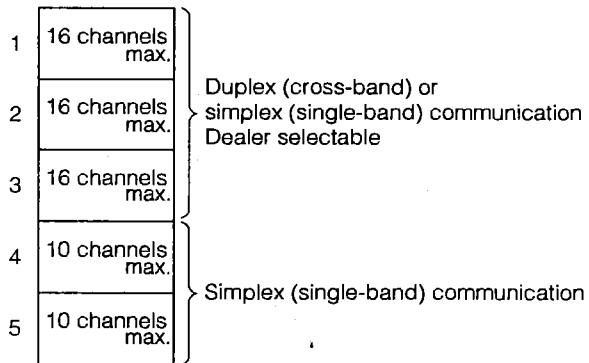

*Note: In this manual, simplex includes semi-duplex operation, as well. Duplex means full-duplex operation.*

# 1.4 Operation Modes

The term *operation mode* is often used in the Instruction Manual for users. The operation mode is actually defined by how you (the dealer) would program each bank number and respective communication method (simplex and duplex). There is not any particular setup procedure for *operation mode* itself. In the way of explanation for the user, however, certain procedures are sometimes referred to as *changing the operation mode* in the Instruction Manual.

The operation modes depend on whether or not the EJ-27D logic board is installed in the radio.

# When Equipped with the EJ-27D Logic Board

The radio provides three operation modes: *radio-phone*, *semi-duplex trunking*, and *two-way radio* (walkie-talkie) modes. Not all the operation modes will be assigned to the banks. Tell the user about the modes available on the radio in detail.



*Note: The radio-phone and semi-duplex trunking modes are inclusively called trunking mode.*

## Radio-phone mode (Full-duplex trunking mode)

When the radio uses a bank (any of the banks 1 through 3) set for duplex communication, it is in the radio-phone mode. The user can hear and talk simultaneously as if he/she were using a telephone. Trunking is activated, so the user does not have to manually select the channel. The radio performs selective and private communications. The user may dial or receive a call from a landline that is connected to the trunking controller.

Note that, during full-duplex trunking communication, the subscriber radio (e.g. DJ-680) is transmitting *and* receiving simultaneously and continuously. Therefore, radio-to-radio calls will be impossible unless it goes through another channel interlinked by a landline.

Normally, the radio will be configured to start up in the radio-phone mode, and the user is likely to work in this mode in most cases.

## Semi-duplex trunking mode (SD trunking mode)

When the radio uses a bank (any of the banks 1 through 3) in which the same frequency band is set for both Tx and Rx, it is in the SD trunking mode. The **(PTT)** key must be pressed for transmission once connection is established by the trunking system. Trunking is activated, so the user does not have to manually select the channel. The radio performs selective and private communications. The user can communicate with a transceiver as well as a telephone in this mode.

## Two-way radio mode

When the radio uses either bank 4 or 5, which are dedicated to simplex (single-band) communication, it is in the two-way radio mode. The radio uses simplex or semi-duplex communication and the user cannot speak while the other party is talking. These banks are not controlled by the EJ-27D logic board and are not for trunking. The radio operates like a normal transceiver:

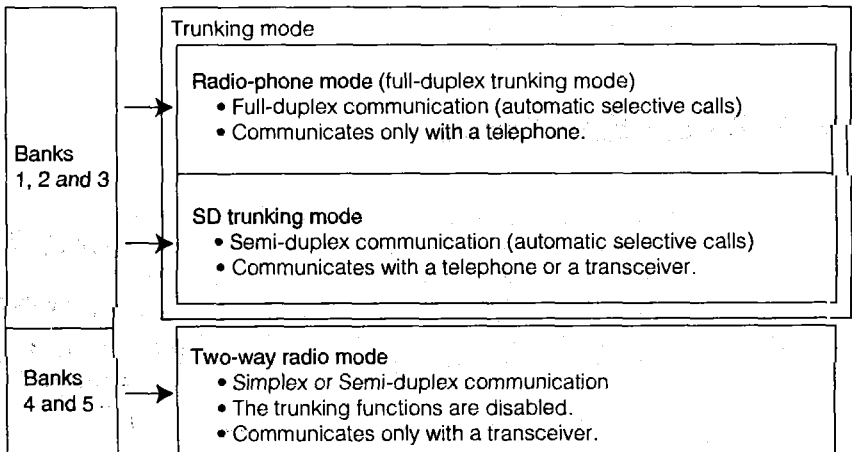

# When Not Equipped with the EJ-27D Logic Board

Without the logic board, the radio provides the operation modes: *duplex*, *semi-duplex*, and *two-way radio* (walkie-talkie) modes. Not all the operation modes will be assigned to the banks. Tell the user about the modes available on the radio in detail.



*Note: The trunking function is not available when the logic board is not installed in the radio.*

## Duplex mode

When the radio uses a bank (any of the banks 1 through 3) set for duplex (cross-band) communication, it is in the duplex mode. The user can then hear and talk simultaneously as if he/she were using a telephone. The radio may dial or receive a call from a telephone\* (or another full-duplex radio). Normally, the radio will be configured to start up in the duplex mode.

## Semi-duplex mode

When the radio uses a bank (any of the banks 1 through 3) set for simplex (single-band) communication, it is in the semi-duplex mode. The user cannot speak while the other party is talking. The radio may communicate with a transceiver as well as a telephone\*.

## Two-way radio mode

When the radio uses either bank 4 or 5, which are dedicated to simplex communication, it is in the two-way radio mode. The user cannot speak while the other party is talking. The radio may communicate with a transceiver as well as a telephone\*.

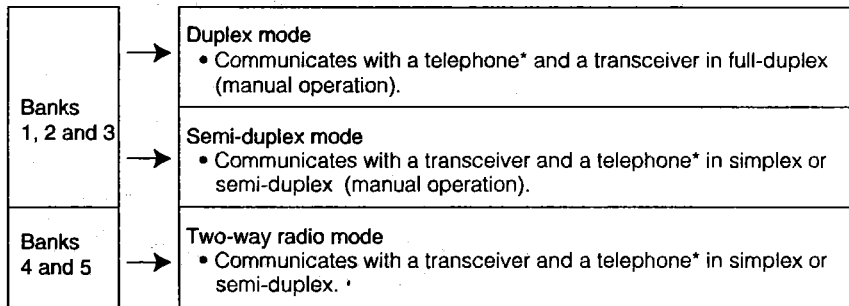

\* : Communication with a telephone is allowed when base stations are equipped with phone-patch.



## 2. Installing the EJ-27D Logic Board

When you need to provide the radio with trunking capability, install the EJ27-D logic board in it and program the board.

 **Caution** You must ground yourself to remove any static charge before touching the logic board and the internal printed-circuit board of the radio. Do not touch any components on these boards.

### 2.1 Installing the Logic Board

To install the EJ-27D logic board in the radio, follow the procedure below.

Steps

1. Unscrew the 6 screws on the rear panel of the radio, and remove the panel (see the figure on the right).
2. Holding the EJ-27D logic board with the side marked "TOP" facing up, identify the connector (see the figure in step 3).

On the printed-circuit board in the radio, identify the connector for the logic board (see the figure in step 3).

3. Place the logic board on the printed-circuit board so that the connector on the logic board is aligned with the one on the printed-circuit board. Gently press on the logic board to snap it into place.

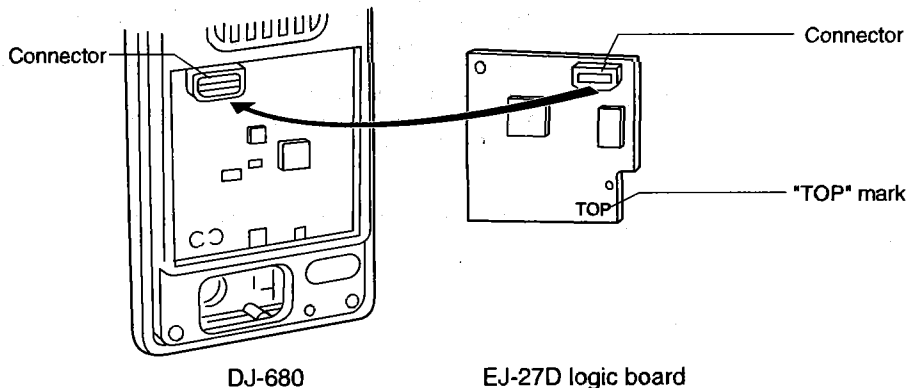
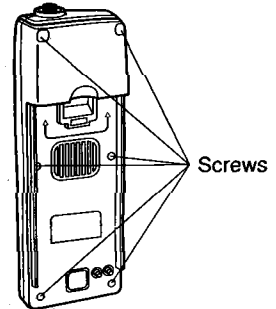







4. Refit the rear panel on the radio, and tighten the screws.

## 2.2 Programming the Logic Board

When the EJ-27D logic board has been installed, configure the board in the logic-board-programming mode. Note that logic-board programming is entirely independent from radio programming.

### Steps

1. Create a temporary bank, which is a dummy bank needed only during logic board programming, by setting any of the banks 1 to 3 for simplex communication.

To do this in the easiest way, hold down the , ,  keys and press the POWER key to enter the dealer mode, press the  key five times to go to the Rx Freq. screen, enter any number as the reception frequency, press the , press the  key, and turn the power off.

For operation details, see 3 "Starting the Radio in the Dealer Mode" through 6.4 "Configuring the Selected Channel (Channel Menu)."

2. While holding down the , press the POWER key to enter the programming mode.

The radio will enter the logic-board-programming mode and will automatically select the temporary bank. Make sure the asterisk ( \* ) next to SCAN is NOT blinking.

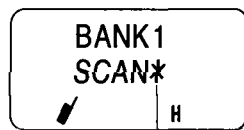

An asterisk steadily light.









*Note: If the asterisk ( \* ) is blinking, you are in the user mode. Turn the power off and retry the operation in this step.*

3. Enter the logic-board-password for programming the logic board, and press the  key. For information about the password, see the EJ-27D Logic Board Manual.

If the password is not accepted, you may have entered the wrong password. Turn the power off and retry from step 2.

4. Program the logic board, following the instructions in the EJ-27D Logic Board Manual.
5. When programming is completed, turn the power off.

Enter the dealer mode and delete the temporary bank. To do this, hold down the , , and  keys and press the POWER key. Press the  key, make sure the temporary bank number appears (if not, use the  or  key to display it), and press the  key. For more information, see 6.6 "Clearing Bank Data."

# 3. Programming on the Channel Editor

When you are to program the radio using the Channel Editor, prepare Alinco's ERW-5 interface cable set. If you have not installed the Channel Editor software on your computer (IBM PC/AT compatible computer), copy the DJ680.EXE file from the distributed floppy disk to an appropriate directory on your computer.

## Steps

1. Remove the battery pack from the radio, and remove the cap from the battery pack mount (see the figure on the right).

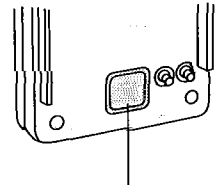

Remove this cap.

2. Make sure the computer is turned off.
3. Connect the radio's internal connector to the computer's COM1 port with the ERW-5 interface cables as shown in the figure below. Plug the AC adapter of the ERW-5 into a wall outlet.

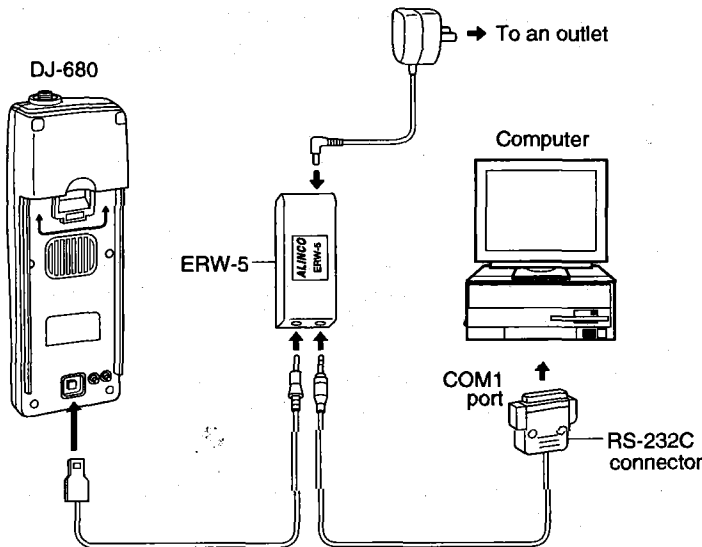

4. Turn the computer on.



*Note: This software works only in the MS-DOS US mode.  
If the computer is in another mode, switch to the US mode.*

5. Go to the directory where the DJ680.EXE is placed. At the DOS prompt, enter *DJ680* and press the Enter key.

The Channel Editor will start, displaying the main menu. Set the parameters for radio operation.



*Note: The parameter settings related to ANI, selective calling, TOT, and BCLO are ignored in banks 1 through 3 if the EJ-27D logic board is installed in the radio.*

6. When the settings are completed, write your data into the radio.

On the radio, while holding down the  $\text{\textcircled{1}}^{\text{OFF}}$ ,  $\text{\textcircled{4}}^{\text{OFF}}$ , and  $\text{\textcircled{7}}^{\text{PMS}}$  keys all at the same time, press the POWER key to turn the radio on. When CLONE appears, press the  $\text{\textcircled{O}}^{\text{STORE}}$  key to switch to READY.

From the Channel Editor, select Radio... on the Main MENU, and select Write on the Radio MENU.

The data you programmed on the software will be transferred to the radio. When the transfer is completed successfully, PASS will appear on the radio.

7. Turn off the computer and radio, and disconnect the cables. Refit the cap and battery pack on the radio.

## 4. Copying Data between Two Radios (Clone Function)

If you have already programmed a master radio, you can use the clone function to copy the data from the master radio to another radio (slave radio). To use this function, you must have the Alinco's ERW-5 interface cable set.



**Caution:** Do not try to copy data to a radio on which the clone function is disabled. If you do, the existing data on that radio will be lost. This function is enabled by default. For information on how to turn on/off the clone function, see "Clone (Clone Func. Screen)" section in 7. "Setting General Radio Parameters."

Steps

1. Remove the battery packs from both of the radios, and remove the caps from the battery pack mounts.
2. Connect the master radio's connector to the slave radio's connector with the ERW-5 interface cables as shown in the figure below. Plug the AC adapter of the ERW-5 into a wall outlet.

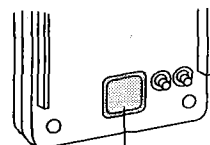

Remove this cap.

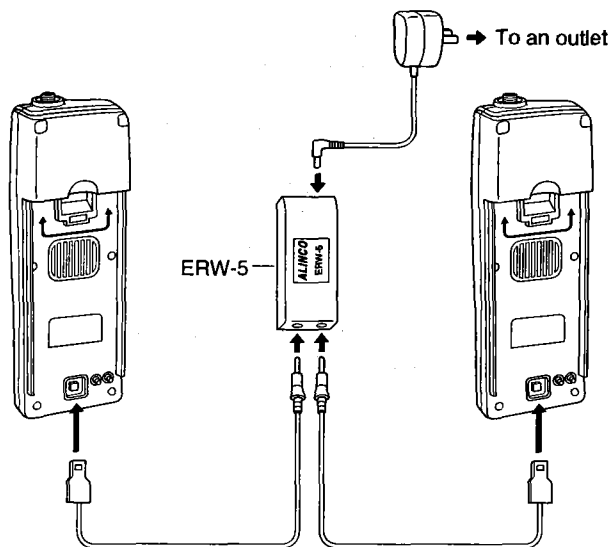

3. While holding down the **(1)**<sup>oz</sup>, **(4)**<sup>oh</sup>, and **(7)**<sup>prs</sup> keys at the same time, turn the power on to enter the clone mode. The radio displays **CLONE**. This operation must be performed on both the master and slave radios.
4. On the slave radio, press the **STORE** key to display **READY**.
5. On the master radio, press the **(PTT)** key to start transferring the data. While the data is being copied, the master radio displays **SEND**, and the slave radio, **LOAD**.



**Caution:** Be careful not to disconnect the cable while copying the data. If you do, the existing data in the slave radio will be lost.

When the operation is completed successfully, **PASS** appears on both radios. If the transfer is unsuccessful, **ERR** appears. Press any key to return to the **CLONE** display, and retry from step 4.

# 5. Programming in the Dealer Mode

This chapter describes how to program the radio in the dealer mode: from entering the dealer mode to selecting the parameter type. The remaining operations in this mode are explained in the later chapters.

Referring to Appendix "Quick Reference" (pages 34-36) may help you in understanding the procedures.

## 5.1 Starting the Radio in the Dealer Mode

To configure the bank parameter or general radio parameters, start the radio in the *dealer mode* as explained below. A quick reference for setting the parameters in the dealer mode is given in Appendix "Quick Reference" at the end of this manual.

**Steps** While holding down the  $\text{2}^{\text{ABC}}$ ,  $\text{5}^{\text{JK}}$ , and  $\text{8}^{\text{TUV}}$  keys at the same time, press the POWER switch to turn the power ON. The radio will start in the dealer mode.

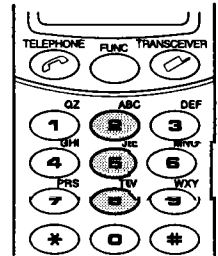

The **Dealer Mode** screen will appear when you have not set the password. Go to 5.3 "Selecting the Type of Parameters (**Dealer Mode** screen)."

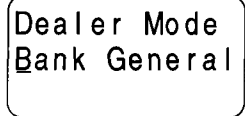

The **Password** screen appears when you have set the password. Go to 5.2 "Entering the Password (**Password** Screen)."

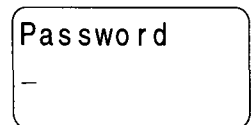

*Note: If the radio displays a screen other than shown above, you will be in the user mode. Turn the radio OFF. Firmly hold down the  $\text{2}^{\text{ABC}}$ ,  $\text{5}^{\text{JK}}$ , and  $\text{8}^{\text{TUV}}$  keys and turn the radio ON again.*

To exit the dealer mode, press the POWER switch to turn the power OFF.

## 5.2 Entering the Password (**Password Screen**)

When the **Password** screen appears at power-on and prompts for the password, enter the correct password following the procedure below. The password is a 3- to 6-digit number you have previously programmed (for information on how to set the password, see 7 "Setting General Radio Parameters").



- Note:**
- If the **Dealer Mode** screen appears just after the radio turns ON, skip this step and go to 5.3 "Selecting the Type of Parameters (**Dealer Mode** screen)."
  - If you forget the password, write a new set of data into the internal EEPROM using the clone function. Note that this operation clears all the parameter settings currently stored in the memory.



Steps

1. Make sure the **Password** screen is displayed.

Password  
\_

2. Use the numeric keys to enter the password (a three- to six-digit number). An asterisk (\*) will appear instead of a digit you enter.

Password  
\*\*\*\_

If you enter a wrong number, use the  or  key to move the cursor ( ) to that position and type over the number.

3. Press the  key.

When the radio accepts the password, the **Dealer Mode** screen will appear. Go to 5.3 "Selecting the Type of Parameters (**Dealer Mode** screen)."



Dealer Mode  
Bank General

If the password is invalid, the radio will still display the password prompt. Press the  key several times until the cursor ( ) is placed at the beginning of the password area, and repeat steps 2 and 3.

## 5.3 Selecting the Type of Parameters (Dealer Mode Screen)

On the **Dealer Mode** screen, select whether to set bank parameters or general radio parameters.

Steps



1. To set the bank parameters, make sure the cursor is at **Bank**. If the cursor is in another position, press the  or  key to move the cursor to **Bank**.

Dealer Mode  
Bank General

2. Press the  key. The **Bank Select** screen will appear. Go to 6 "Configuring Banks."

Bank Select  
1 (None)

Steps

1. To set the general radio parameters, press the  or  key to place the cursor at **General**.

Dealer Mode  
Bank General

2. Press the  key. The **DTMF Burst** screen will appear. Go to 7 "Setting General Radio Parameters."

DTMFBurst  
60 /120





# 6. Configuring Banks (*Bank Select Screen*)

After you select **Bank** on the **Dealer Mode** screen, go through the steps in 6.1 "Selecting a Bank to be Configured" through 6.5 "Turning Selective Calling ON/OFF" to set the bank parameters. This chapter also covers how to clear parameter values set for a bank or channel.

## 6.1 Selecting a Bank to be Configured (*Bank Select Screen*)

Select a bank for which you want to set the bank parameters. Make sure the radio displays the **Bank Select** screen.

Steps

1. On the **Bank Select** screen, press the  or  key until the desired bank number appears.

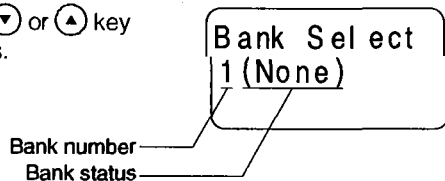



**Note:** ■ *The bank status appears at the right of the bank number. This is just an indication and cannot be changed in this step. When you first use the radio, (None) will appear with every bank number. The bank status varies as follows.*

**(None):** *Bank is disabled (not programmed).*

**(DUP):** *Bank is enabled and set for full-duplex communication.*

**(SMP):** *Bank is enabled and set for semi-duplex or simplex communication.*

- *At this point, you can clear the parameter settings for the bank number currently displayed. Press the  key. The bank status will change to (None).*

2. Press the  key. The bank menu will appear. Go to 6.2 "Configuring the Selected Bank."

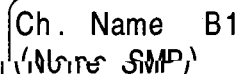

The diagram shows a rectangular screen with the text "Ch. Name B1" and "(None SMP)" below it.

## 6.2 Configuring the Selected Bank (Bank Menu)

On the bank menu, set the parameters for the bank you selected in the previous section. The bank parameters include bank naming, communication method, and selective calling setting. The bank menu depends on whether or not the bank has been programmed.

### Unprogrammed bank

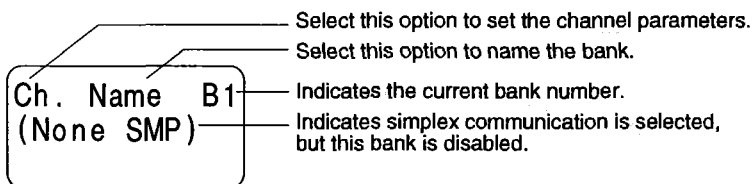

### Preprogrammed bank

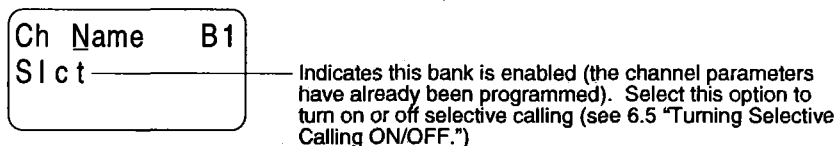

## Naming the Bank

Assign a new name to the selected bank. Each bank has its own default name, such as BANK1, BANK2, and so on.

Steps

1. Press the  key to place the cursor (|) at the **Name**.

Ch. Name B1  
(None SMP)

2. Press the  key to display the **Bank Name** screen.

Bank Name B1  
BANK1

3. Enter a new bank name.

A bank name can contain up to 5 numeric, alphabetical, and/or special characters.

To enter numbers (0 to 9), use the numeric keys.

To enter letters (A to Z), press the  $\text{FUNC}$  key to display **F**, then press the  $\text{1}$  key to switch to the letter-entry mode. Enter the desired letter with the numeric key having the corresponding character marked at the upper-right. The letter to be entered depends on which key you press and how many times you press it (e.g. to enter C, press the  $\text{2}^{\text{ABC}}$  key three times). When you enter a letter, press the  $\text{▲}$  key to move the cursor to the next column.

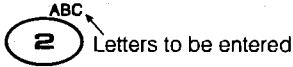

If you want to enter a numeric character after engaging the letter-entry mode, press the  $\text{FUNC}$  key, and press the  $\text{1}^{\text{0Z}}$  key again. You will return to the number-entry mode.

To move the cursor to the right, press the  $\text{▲}$  key, and to the left, press the  $\text{▼}$  key.

If you enter a wrong character, move the cursor to that character and type over the character.

To delete a character, move the cursor to that character, enter the letter-entry mode (the  $\text{FUNC}$  and  $\text{1}^{\text{0Z}}$  keys), and press the  $\text{□}$  key.

To clear the entire entry, press the  $\text{CLEAR}$  key.

**Example:** To enter ALU:

- a. Press the  $\text{FUNC}$  key, then the  $\text{1}^{\text{0Z}}$  key to enter the character-entry mode.
- b. Press the  $\text{2}^{\text{ABC}}$  key once to enter A.
- c. Press the  $\text{▲}$  key to move the cursor to the next column.
- d. Press the  $\text{5}^{\text{4L}}$  key three times to enter L.
- e. Press the  $\text{▲}$  key to move the cursor to the next column.
- f. Press the  $\text{5}^{\text{TUV}}$  key twice to enter U.

4. Press the  $\text{STORE}$  key to return to the bank menu.

Ch. Name B1  
(None SMP)

## Selecting Duplex or Simplex Communication

Banks 1 through 3 can be configured for either duplex or simplex communication. If you are programming bank 4 or 5, skip this procedure because they are dedicated to simplex communication (go to the next section 6.3 "Selecting a Channel to be Configured").

The default is simplex communication, and **(None SMP)** appear on the bank menu.



*Note: When Slct appears on the bank menu, channel data has been already configured. If you need to change the communication method, you must first clear the channel parameter settings. Press the <sup>STORE</sup> key to return to the Bank Select screen, check the bank number, and press the <sup>CLEAR</sup> key to clear the data. Then, try the operation below.*

Steps

To use the bank for simplex communication, make sure **(None SMP)** appears on the bank menu.

Ch. Name B1  
**(None SMP)**

To use the bank for duplex communication, press the <sup>RUNC</sup> key, then the 1 key to switch to **(None DUP)**. The radio toggles between **(None SMP)** and **(None DUP)** every time you press these keys.

Ch. Name B1  
**(None DUP)**

In either case, go to the next section 6.3 "Selecting a Channel to be Configured."



*Note: Do not press the <sup>STORE</sup> key to return to the Bank Select screen at this point, or the radio will abort your change. The communication method setting is stored together with the channel parameter settings (after completing the procedure in 6.4 "Configuring the Selected Channel").*



## 6.3 Selecting a Channel to be Configured

After selecting the communication method, select the channel for which you want to set the channel parameters.



*Note: Be sure to set the channel parameters after selecting the communication method (see the previous sub-section "Selecting Duplex or Simplex Communication"). The communication method cannot be changed after setting channel parameters.*

Steps

1. On the bank menu, press the  or  key to place the cursor at Ch.

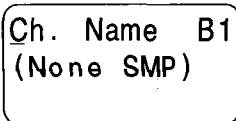

Ch. Name B1  
(None SMP)

2. Press the  key to display the Ch. Select screen. (None) will appear next to the channel number if the channel has not been programmed.

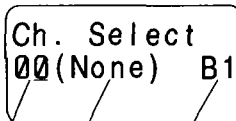

Ch. Select  
00 (None) B1

Channel number

This indicates the channel has not been configured, and does not appear if the channel has been already programmed.

Bank number

3. Press the  or  key several times until the desired channel number appears.



*Note: At this point, you can clear the parameter settings for the channel number currently displayed. Press the  key. (None) will appear next to the channel number.*

4. Press the  key to display to the channel menu. Go to the next section 6.4 "Configuring the Selected Channel."

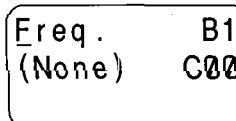

Freq. B1  
(None) C00

## 6.4 Configuring the Selected Channel (Channel Menu)

On the channel menu, set the frequency for the channel you selected in the previous section. Tone squelch, tone decoder, and scrambler parameters can be also programmed for channels in banks 4 and 5 when the logic board is installed in the radio, and in all banks when the logic board is not installed.

This menu depends on whether or not the channel has been programmed.

### Not programmed channel

When the channel has not been programmed, you must first set the transmission and reception frequencies. Go to the next sub-section "Setting the Frequency."

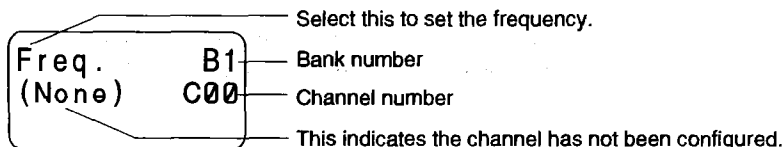

### Already programmed channel

When the channel has already been programmed, you can go to the next sub-section "Setting the Frequency" or jump to "Setting TSQ, Tone encoder, and Scrambler" on page 24.

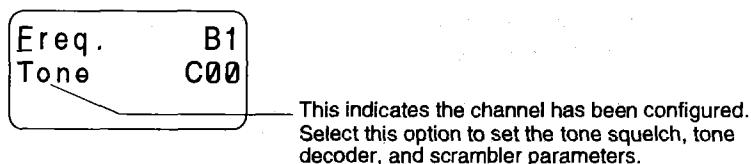

## Setting the Frequency

For channels in banks 1, 2, and 3, set both the reception and transmission frequencies. For channels in banks 4 and 5, set the reception frequency and offset value.

### Steps

1. On the channel menu, make sure the cursor is at Freq. If not, press the  $\blacktriangledown$  or  $\blacktriangle$  key to move it.

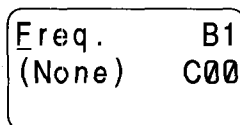

2. Press the  $\text{SR}$  key to go to the Rx Freq. screen.

The current reception frequency will appear, if already programmed. The default is 000.0000.

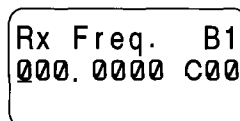

3. Use the numeric keys to enter the reception frequency.

Rx Freq. B1  
450.0000 C00

For channels in banks 1, 2, and 3, the allowable reception frequency range depends on the communication method (duplex or simplex) assigned for that bank. Banks 4 and 5 are dedicated to simplex communication. The frequency range is listed below.

V version	Full-duplex	450 - 470 MHz
	Simplex	155 - 174 MHz
U version	Full-duplex	136 - 155 MHz
	Simplex	400 - 420 MHz

If you enter a wrong number, use the  $\nabla$  or  $\blacktriangle$  key to place the cursor at that number, and type over the number.

4. Press the  $\text{BANK}$  key.

For channels in banks 1, 2, and 3, the Tx Freq. screen will appear. If the channel has not been programmed, the frequency value you entered in the previous step will still appear. If the channel has been already programmed, the current frequency will appear. In either case, go to step 5.

Tx Freq. B1  
000.0000 C00

For channels in banks 4 and 5, the offset screen will appear, indicating the current offset. Go to step 6.

Offset B4  
-00.000 C00

5. On the Tx Freq. screen, enter the transmission frequency. The range is the same in both simplex and duplex communications.

Tx Freq. B1  
155.0000 C00



V version	155 - 174 MHz
U version	400 - 420 MHz



If you enter a wrong number, use the  $\nabla$  or  $\blacktriangle$  key to place the cursor at that number, and type over the number.

When you enter the frequency, skip the next step and go to step 7.

6. On the offset screen, enter the frequency offset with the numeric keys. If offset is not required, set it to 00.000

Offset      B4  
-15.0000 C00

To change the sign (+ and -), press the  key, then the  key.

If you enter a wrong number, use the  or  key to place the cursor at that number, and type over the number.

7. Press the  key to return to the channel menu. Tone will appear, indicating the frequency has been set.

Ereq.      B1  
Tone      C00



*Note: If you turn the radio off before pressing the  key, the radio may abort your changes.*

If you want to set frequency for another channel, press the  key again to return to the Ch. Select screen, and repeat the procedure in the previous section 6.3 "Select a Channel to be Configured" from step 2.

If you want to set TSQ, tone encoder, and/or scrambler parameters, go to the next sub-section "Setting TSQ, Tone Encoder, and Scrambler."





## Setting TSQ, Tone Encoder, and Scrambler



When the channel has been configured with a frequency, you can set the parameters for tone squelch (TSQ, CTCSS), tone encoder, and/or scrambler. These functions are available only on channels in banks 4 and 5 when the radio is equipped with the logic board, and in all banks when the radio is not equipped with the logic board.

The procedure in this sub-section covers the steps for setting all these parameters. However, you can press the  key to skip unnecessary setting screens and go to the desired screen. The following table lists the parameter names, screen names, default settings and corresponding step number.

Parameter	Screen	Default	Step
Tone squelch	Tone Dec.	Disabled	3
Tone frequency for tone squelch	Rx Tone	67.0 Hz	4
Tone encoder	Tone Enc.	Disabled	5
Tone frequency for tone encoder	Tx Tone	67.0 Hz	6
Scrambler	Scramble	Disabled	7

When all the desired settings are completed, you can, on any screen, press the  key to store the changes. If you turn the power off before pressing the  key, the radio will abort your changes.

Steps



1. On the channel menu, press the  or  key to place the cursor at **Tone**.

Freq.	B4
Tone	C00



2. Press the  key to go to the **Tone Dec.** screen.

3. On the **Tone Dec.** screen, select whether or not to activate the TSQ.

Tone Dec.	B4
Non/Dec	C00

To turn ON the TSQ, press the  or  key to place the cursor at **Dec.** Press the  key to go to **Rx Tone** screen. Go to step 4.

To turn OFF the TSQ, place the cursor at **Non.** Press the  key several times to skip to the desired step.

4. On the **Rx Tone** screen, select the tone frequency of the tone squelch (CTCSS), that is, the tone frequency for reception. Press the  or  keys until the desired frequency appears. The default is 67.0 Hz.

Rx Tone	B4
67.0	C00

Press the  key once or more to skip to the desired step.

5. On the **Tone Enc.** screen, select whether or not to activate the tone encoder.

Tone Enc.	B4
Non/Enc	C00

To turn the encoder ON, press the  $\blacktriangledown$  or  $\blacktriangle$  key to select **Enc.** Press the  $\text{END/CL}$  key to display the **Tx Tone** screen. Go to step 6.

To turn the encoder OFF, press the  $\blacktriangledown$  or  $\blacktriangle$  key to select **Non.** Press the  $\text{END/CL}$  key twice to skip to the **scrambler** setting, if needed.

6. On the **Tx Tone** screen, select the tone frequency of the tone encoder, that is, tone frequency for transmission. Use the  $\blacktriangledown$  or  $\blacktriangle$  keys until the desired frequency appears. The default is 67.0 Hz.

Tx Tone	B4
67.0	C00

Press the  $\text{END/CL}$  key to go to the **Scramble** screen, if needed.

7. On the **Scramble** screen, select whether to enable or disable the scrambler. Press the  $\blacktriangledown$  or  $\blacktriangle$  key to select **Scr** to turn scrambler ON, and **Non** to turn it OFF.

Scramble	B4
Non/Scr	C00

You can return to the **Tone Dec.** screen by pressing the  $\text{END/CL}$  key.

8. Press the  $\text{STORE}$  key to store your changes and return to the channel menu.

Freq.	B4
Tone	C00

When you want to program another channel in the current bank, press the  $\text{STORE}$  key once to return to the **Ch. Select** screen, and repeat from step 3 in 6.3 "Selecting a Channel to be Configured."

When you have completed the settings for all the channels and need to turn on selective calling for the current bank, go to the next section 6.5 "Turning Selective Calling ON/OFF."

When you want to configure another bank, press the  $\text{STORE}$  key three times to return to the **Bank Select** screen. Repeat steps from 6.1 "Selecting a Bank to be Configured."



## 6.5 Turning Selective Calling ON/OFF



Selective calling is available in banks 4 and 5 when the radio is equipped with the EJ-27D logic board, and in all banks when the radio has no logic board.

You can set the selective calling parameter for banks in which channel parameters have been already set (Slct should appear on the bank menu). The selective calling is set to OFF by default.

### Steps

1. If you have just completed the procedure in the previous section (channel menu is displayed) and want to set the selective calling parameter in the current bank, press the <sup>STORE</sup> key twice to go to the bank menu (Ch. Name will appear on the first line).

Otherwise, go to the **Bank Select** screen, and press the  or  key until the desired bank number appears. Press the <sup>SEND</sup> key to go to the bank menu.



2. On the bank menu, use the  or  key to place the cursor (|) at Slct.

```
Ch. Name   B4
Slct
```

3. Press the <sup>SEND</sup> key to display the Slct Call screen.

```
Slct Call B4
Of f/On
```

4. Turn selective calling ON or OFF.

To turn ON selective calling, press the  or  key to select On. To turn it OFF, select Off.

5. Press the <sup>STORE</sup> key to return to the bank menu.

If you turn the power off before pressing the <sup>STORE</sup> key, the radio will abort your changes.

## 6.6 Clearing Bank Data

You can clear all the parameter settings you have made for a given bank. This procedure erases channel data for all the channels in that bank, and returns other bank parameters to their default values.

Steps

1. On the Bank Select screen, press the  $\nabla$  or  $\blacktriangle$  key until the desired bank number appears.

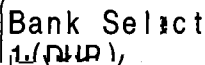

Bank Select  
1 (None)

2. Press the  $\text{CLEAR}$  key. (None) will appear at the right of the bank number.



Bank Select  
1 (None)

## 6.7 Clearing Channel Data

You can clear all the parameter settings for a given channel. This procedure erases the frequency settings and also returns the other parameters to the default settings.

Steps

1. On the Bank Select screen, press the  $\nabla$  or  $\blacktriangle$  key until the desired bank number appears.

2. Press the  $\text{SEND}$  key to go to the Ch. Name screen.

3. Make sure the cursor is placed at **Ch**, and press the  $\text{SEND}$  key again.

4. Press the  $\nabla$  or  $\blacktriangle$  key until the desired channel number appears.

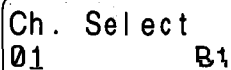

Ch. Select  
01 B1

5. Press the  $\text{CLEAR}$  key. (None) will appear at the right of the channel number.

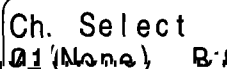

Ch. Select  
01 (None) B1

# 7. Setting General Radio Parameters (*DTMF Burst Screen*)

After you select **General** on the **Dealer Mode** screen, go through the steps in this section to set the general radio parameters.

Your radio should display the **DTMF Burst** screen. From this screen, you can press the **END/CL** key to skip unnecessary setting screens and go to the desired screen. When the settings are completed, press the **STORE** key to return to the **Dealer Mode** screen. If you turn the power off before pressing the **END/CL** or **STORE** key, the radio will abort your changes.

The following table lists the parameter names, screen names, and default settings.

Parameter	Screen	Default
DTMF burst time	DTMF Burst	60 ms
ANI transmission timing	ANI Send	Disabled
ANI code	ANI Code	-
ID code for selective calling	Slct ID Code	000
Middle Code for selective calling	Slct Middle	#
Delay for selective calling	Slct Delay	400 ms
TOT (Time Out Timer)	TOT Func.	Disabled
BCLO (Busy Channel Lock Out)	BCLO Func.	Disabled
Password	Password	Disabled
Transmission command	Send Data	1 *
Clone	Clone Func.	Enabled



- Note:**
- *DTMF, ANI, selective calling, TOT, and BCLO are available on channels in banks 4 and 5 when the radio is equipped with the logic board, and in all banks when the radio is not equipped with the logic board.*
  - *When you enable the selective calling function on the bank menu (see 6.5 "Turning Selective Calling ON/OFF"), set the ID code, middle code, and delay on the appropriate radio parameter screens.*

## DTMF Burst Time (*DTMF Burst Screen*)

On the **DTMF Burst** screen, select the DTMF burst time (the duration of the DTMF tone). This value will also serve as the interval between tones.

Steps

Use the **▼** or **▲** key to select an option.

Select:	To:
60	Set the DTMF time to about 60 ms.
120	Set the DTMF time to about 120 ms.

DTMF Burst  
60 / 120

To go to the next screen, press the **END/CL** key. To store your change and return to the **Dealer Mode** screen, press the **STORE** key.

## ANI Transmission Timing (*ANI Send Screen*)

On the **ANI Send** screen, select when you want the radio to send the ANI (automatic number identification) code, or disable the ANI function.

**Steps** Use the  $\nabla$  or  $\blacktriangle$  key to select an option.

Select:	To:
Non	Disable the ANI function.
Top	Send the ANI code at the beginning of transmission.
Lst	Send the ANI code at the end of transmission.
Bth	Send the ANI code at the beginning and end of transmission.

ANI Send Non  
/Top/Lst/Bth

When you select **Top**, **Lst**, or **Bth**, press the  $\text{END/CL}$  key once to set the ANI code on the **ANI Code** screen. Go to the next sub-section "ANI Code (*ANI Code Screen*)."

When you select **Non**, press the  $\text{END/CL}$  key twice or more to go to the desired screen, or press the  $\text{STORE}$  key to return to the **Dealer Mode** screen.

## ANI Code (*ANI Code Screen*)

When you enable the ANI function on the **ANI Send** screen, you need to set the ANI code.

**Steps** Use the numeric keys to enter the desired code. The ANI code can contain up to 16 digits, but only 12 digits are visible at once. When you enter the twelfth or later digits, the numbers you have already entered will shift to the left.

ANI Code

-

To clear the existing value, press the  $\text{CLEAR}$  key.

To move the cursor, press the  $\nabla$  or  $\blacktriangle$  key.

To go to the next screen, press the  $\text{END/CL}$  key. To store your changes and return to the **Dealer Mode** screen, press the  $\text{STORE}$  key.

## ID Code for Selective Calling (*Slct ID Code Screen*)

On the **Slct ID Code** screen, enter the ID code used in selective calling. When selective calling is enabled, the radio outputs the party's ID code, a one-digit middle code, and the radio's ID code in that order at the beginning of transmission. The radio unmutes the squelch when it receives the middle code following its own code.

**Steps** Use the numeric keys to enter a three-digit ID code.

To clear the existing value, press the **CLEAR** key.

To move the cursor, press the **▼** or **▲** key.

If you want to set the middle code, press the **END/CL** key to go to the **Slct Middle** screen. To store your changes and return to the **Dealer Mode** screen, press the **STORE** key.

Slct ID Code  
000

## Middle Code for Selective Calling (*Slct Middle Screen*)

On the **Slct Middle** screen, enter the middle code used in selective calling.

**Steps** Press the **▼** or **▲** key until the desired character appears. The possible options are numbers 0 through 9 and a pound sign (#).

If you want to set the delay for selective calling, press the **END/CL** key to go to the **Slct Delay** screen. To store your changes and return to the **Dealer Mode** screen, press the **STORE** key.

Slct Middle  
Code #

## Delay for Selective Calling (*Slct Delay Screen*)

On the **Slct Delay** screen, set the time when the radio starts transmission to when it outputs the first digit of the DTMF code. You may need to set the delay time when using selective calling if transmitting through a repeater. Generating a delay prevents the radio from outputting the DTMF code until the repeater activates.

**Steps** Use the **▼** or **▲** key to select options.



Select:	To:
400	Set to 400 ms.
1000	Set to 1000 ms.

Slct Delay  
400/1000



To go to the next screen, press the **END/CL** key. To store your changes and return to the **Dealer Mode** screen, press the **STORE** key.

## TOT (Time Out Timer) (TOT Func. Screen)

On the **TOT Func.** screen, select the maximum transmission time. When the user transmits for the time you set here, the time-out timer (TOT) expires and transmission is prohibited. You can also disable the TOT.

**Steps** Press the  or  key until the desired option appears. The range is from 30 through 450 seconds, and segmented in every 30-second intervals. Selecting OFF disables the TOT.

TOT Func.  
OFF

To go to the next screen, press the  key. To store your changes and return to the **Dealer Mode** screen, press the  key.



## BCLO (Busy Channel Lock Out) (BCLO Func. Screen)

On the **BCLO Func.** screen, enable or disable the BCLO. BCLO prevents transmission on a channel which is receiving a signal with a tone other than the one for the radio's group.

**Steps** Use the  or  key to select the desired option.

Select:	To:
Dis	Disable the BCLO.
Ena	Enable the BCLO.

BCLO Func.  
Dis/Ena

To go to the next screen, press the  key. To store your changes and return to the **Dealer Mode** screen, press the  key.



## Password (Password Screen)

On the **Password** screen, you can set the password to protect the parameter settings from being changed by others. Once you set the password, the radio prompts you to enter the password every time you try to enter the dealer mode. If no password is set, you can enter the dealer mode immediately after turning the radio ON.





*Note: Be sure to write down the password you set here. If you forget the programmed password, you need to clear it before you can enter the dealer mode again. In such case, use the clone function to overwrite new data into the internal EEPROM. Note that this operation also clears all the other parameter settings.*

**Steps** Use the numeric keys to enter the password. The password can contain 3 to 6 digits.

To move the cursor, use the  or  key.

To clear the existing password, press the  key.

To go to the next screen, press the  key. To store your changes and return to the **Dealer Mode** screen, press the  key.

Password  
\_



If only one or two digits has been entered, the radio will abort your entry and disable the password function.





## Transmission Command (*Send Data* Screen)

On the **Send Data** screen, select the transmission command (1\* or 2\*) used in the radio-phone mode (full-duplex mode when the radio is equipped with the EJ-27D logic board). The radio outputs the transmission command when the user presses the  key when talking to the other party.

Steps

Use the  or  key to select the desired option from 1\* and 2\*.

To go to the next screen, press the  key. To store your changes and return to the **Dealer Mode** screen, press the  key.

Send Data  
1\* /2\*



## Clone (*Clone Func.* Screen)

On the **Clone Func.** screen, enable or disable the clone function. Disabling this function protects the stored parameter settings from being copied to another unit. However, you can still use the clone function to write data into your radio.





*Caution Do not transfer data from the radio to another radio when the clone function is disabled. If you do, the existing data on the destination radio will be erased and lost though the data on the original radio remains.*

Steps

Use the  or  key to select the desired option.

Select:	To:
Dis	Disable the clone function.
Ena	Enable the clone function.

Clone Func.  
Ena/Dis

To return to the **DTMF Burst** screen, press the  key. To store your changes and return to the **Dealer Mode** screen, press the  key.

## 8. Initializing the Memory

You can clear all the parameter settings in the memory. Once this operation is done, you can no longer enter the user mode unless you configure a bank in the dealer mode.

Steps

1. On the Dealer Mode screen, press the  key.

All the elements on the display are turned on.

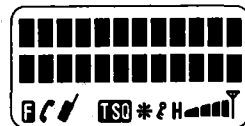

2. Press the POWER switch to turn the power off.

3. Press the POWER switch again to turn the power on.

The radio displays nothing while processing. After a while E appears indicating the entire data in the memory has been cleared.

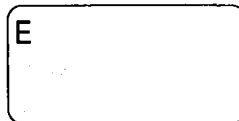



At this point, if you turn the power off and on to enter the user mode, **NO** will appear indicating the radio is not programmed.

## 9. Checking the LCD

If you suspect there is something wrong with the LCD, turn on all the elements on the display following the procedure below.

Steps

1. On the Dealer Mode screen, press the  key.

Press the  key again to return to the Dealer Mode screen.



# Appendix Quick Reference

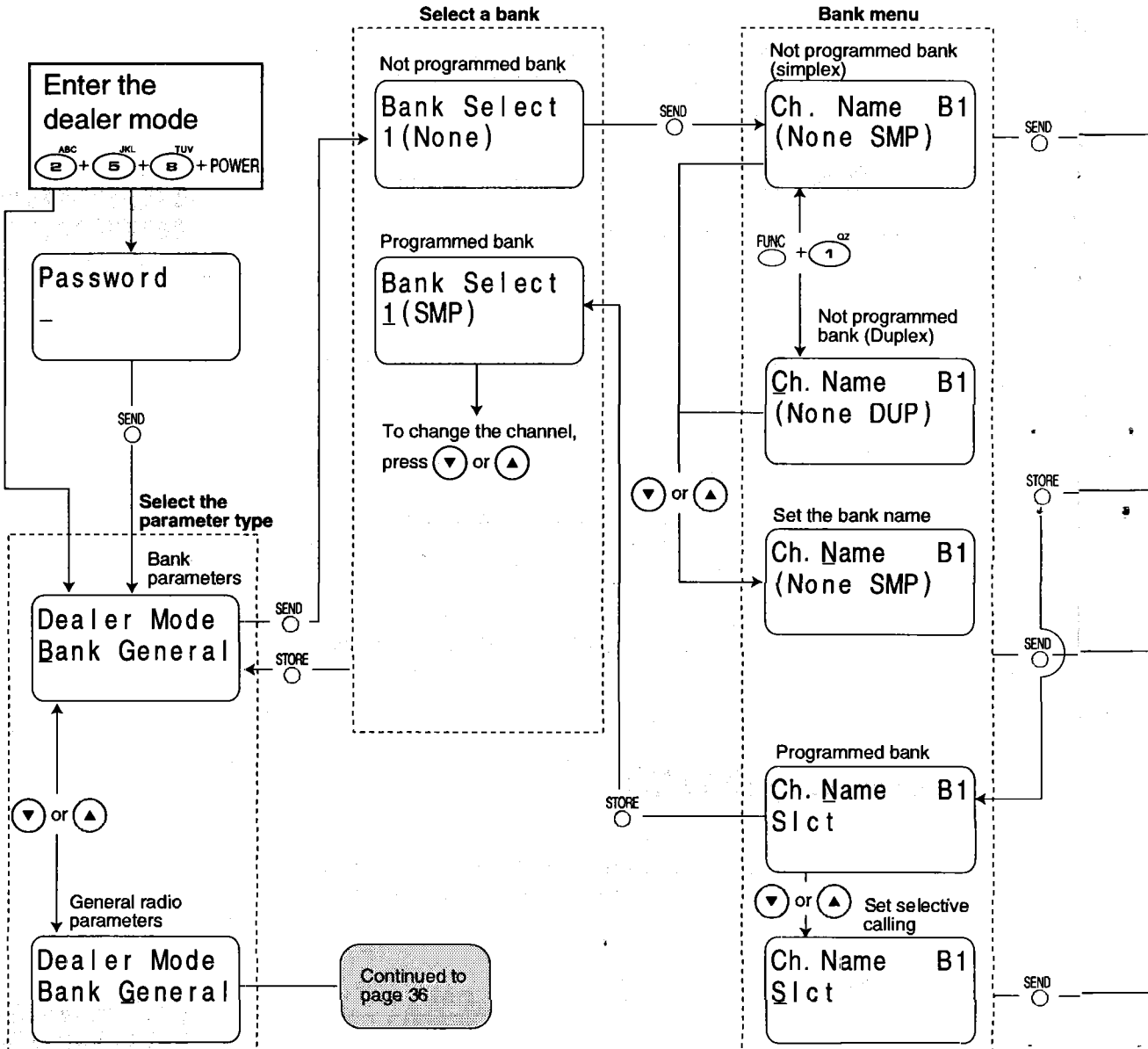

# Appendix Quick Reference

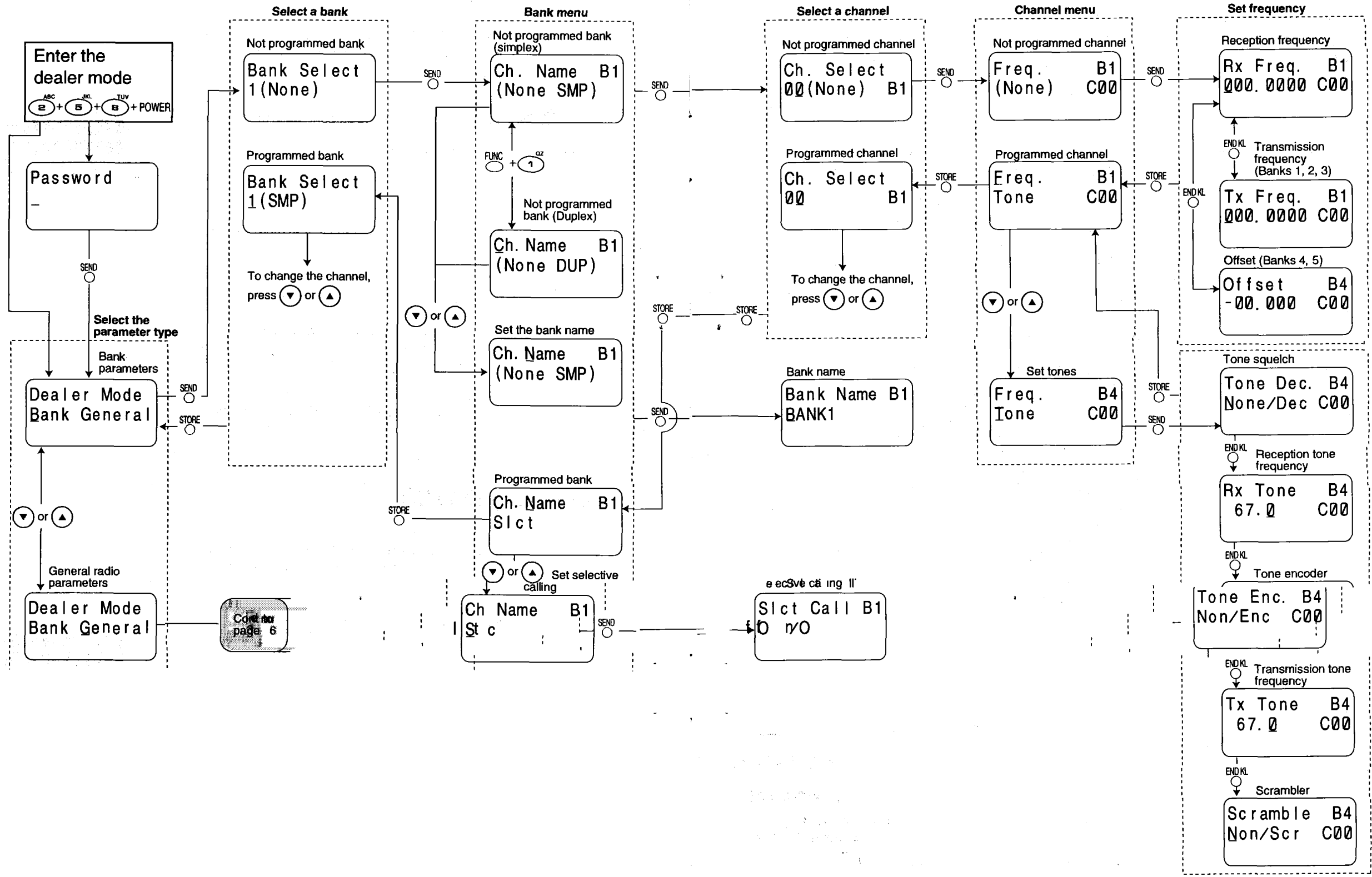



Set general bank parameter

Dealer Mode  
Bank General

SEND

STORE

Burst time

DTMF Burst  
60 / 120

END KL

ANI timing

ANI Send Non  
/Top/Lst/Bth

END KL

ANI code

ANI Code  
-

END KL

ID code for  
selective calling

Slect ID Code  
000

END KL

Middle code for  
selective calling

Slect Middle  
Code #

END KL

Delay for  
selective calling

Slect Delay  
400 / 1000

Clone

Clone Func.  
Ena/Dis

END KL

END KL

Transmission  
command

Send Data  
1\* / 2\*

END KL

Password

Password  
-

END KL

BCLO

BCLO Func.  
Dis/Ena

END KL

TOT

TOT Func.  
OFF

END KL

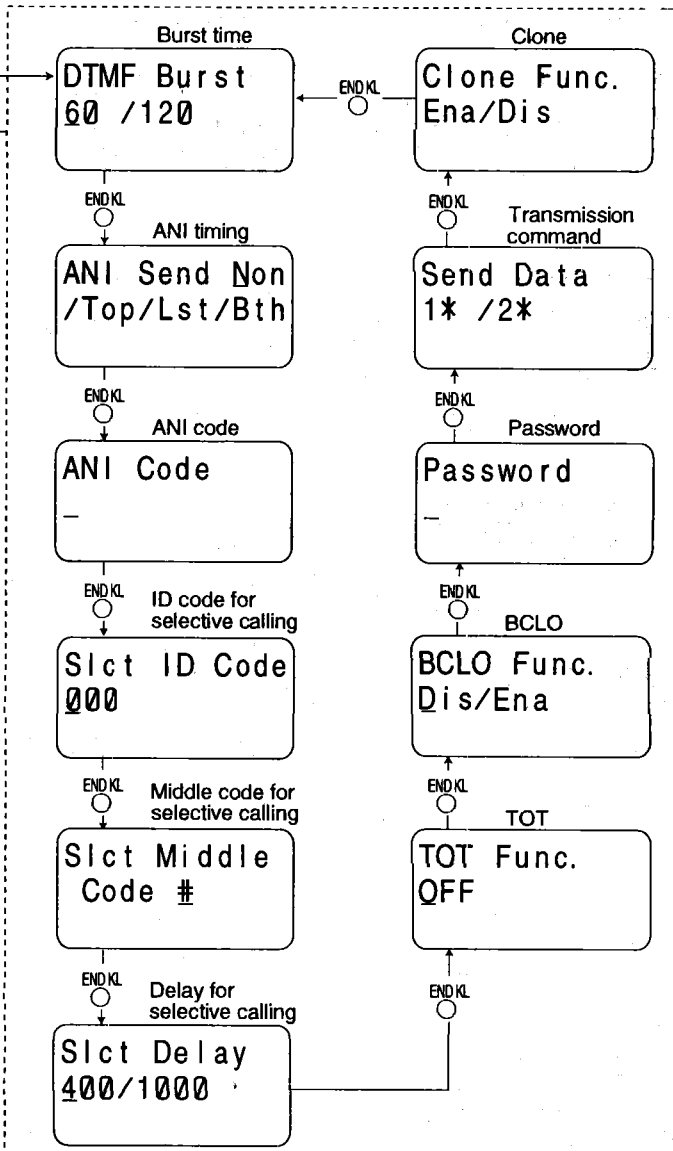

NOTES:  
 1. THIS SCHEMATIC TO BE USED IN CONJUNCTION WITH COMP NT LOCATION 502-3712  
 2. \* ADD FOR SCRAMBLER OPTION  
 3. \*\* OPEN FOR SCRAMBLER OPTION

REV	DESCRIPTION	DATE	ENG	QCD
ECO 95045	INITIAL RELEASE LEVEL C			

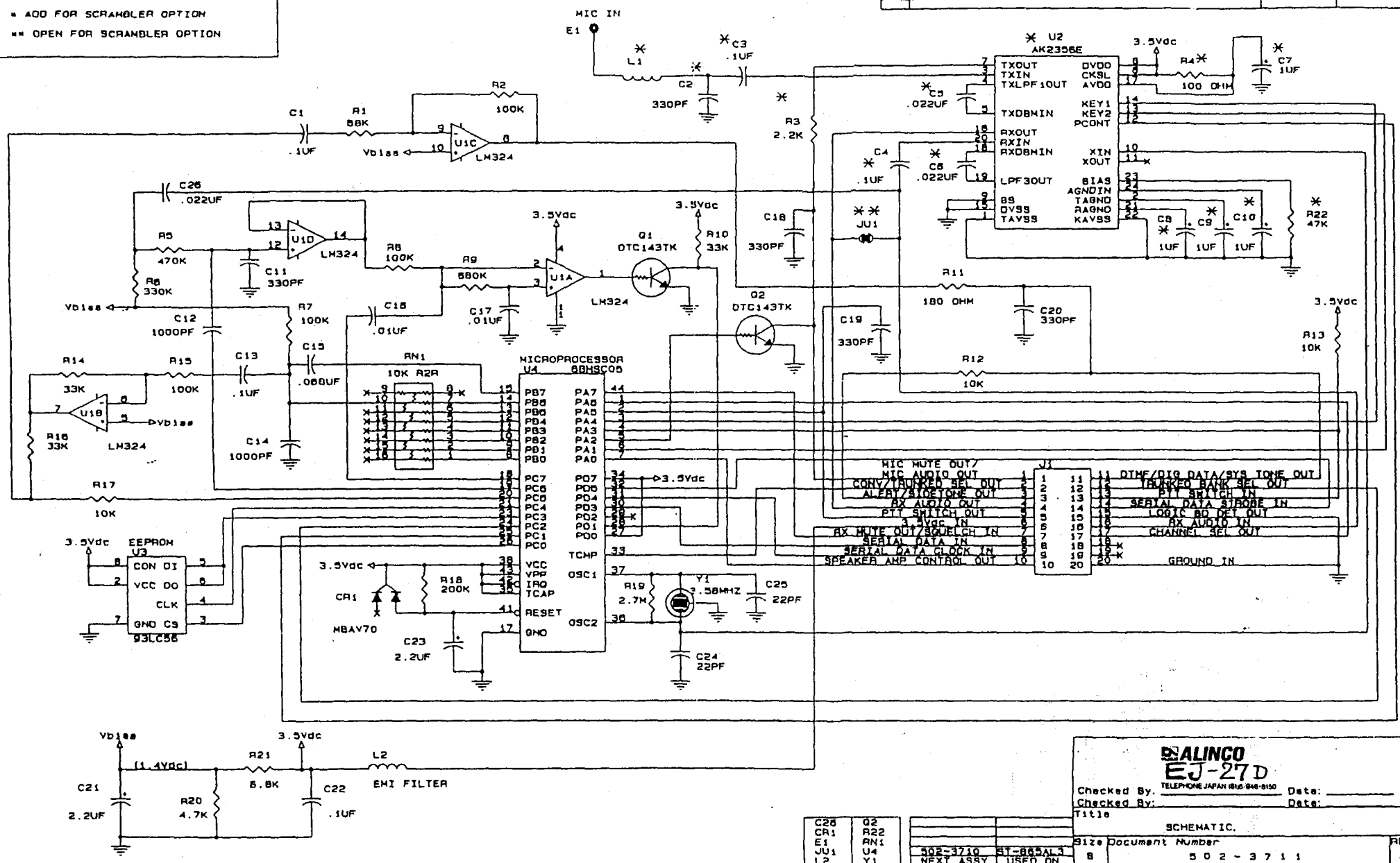

**ALINCO**  
**EJ-27D**  
 TELEPHONE JAPAN 180-940-8100

Checked By: \_\_\_\_\_ Date: \_\_\_\_\_  
 Checked By: \_\_\_\_\_ Date: \_\_\_\_\_

Title: SCHEMATIC.

C25	Q2		
CR1	R22		
E1	RN1		
JU1	U4	502-3710 ST-BASAL	Size Document Number
L2	Y1	NEXT ASSY USED ON	8 502-3711
LAST USED	APPLICATIONS	Date: August 3, 1995	Printed: 1 of 1