

MT - 317

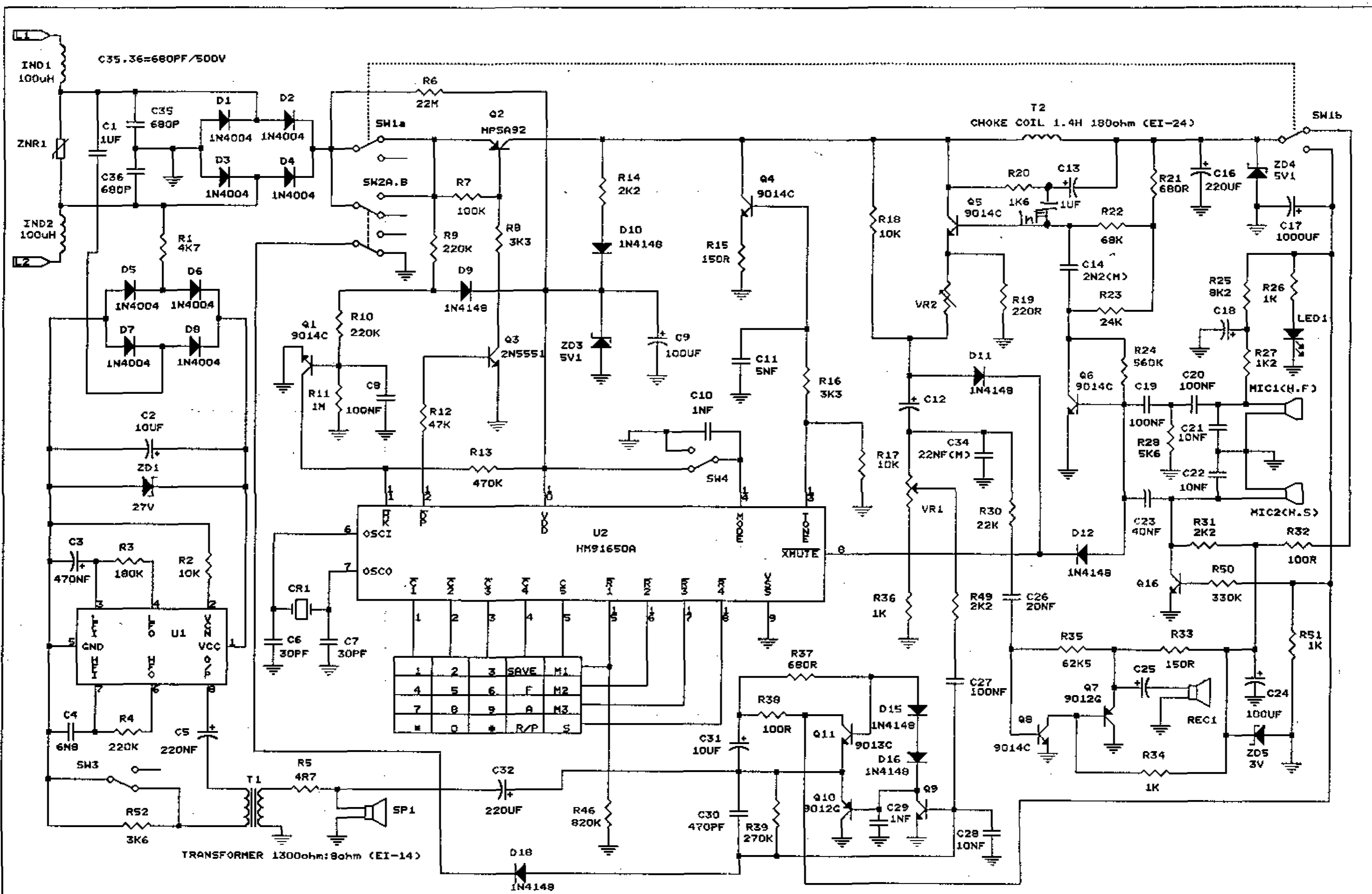

MT - 317