

Für guten Kontakt bei starken Impulsen

For good contact at high pulse ratings

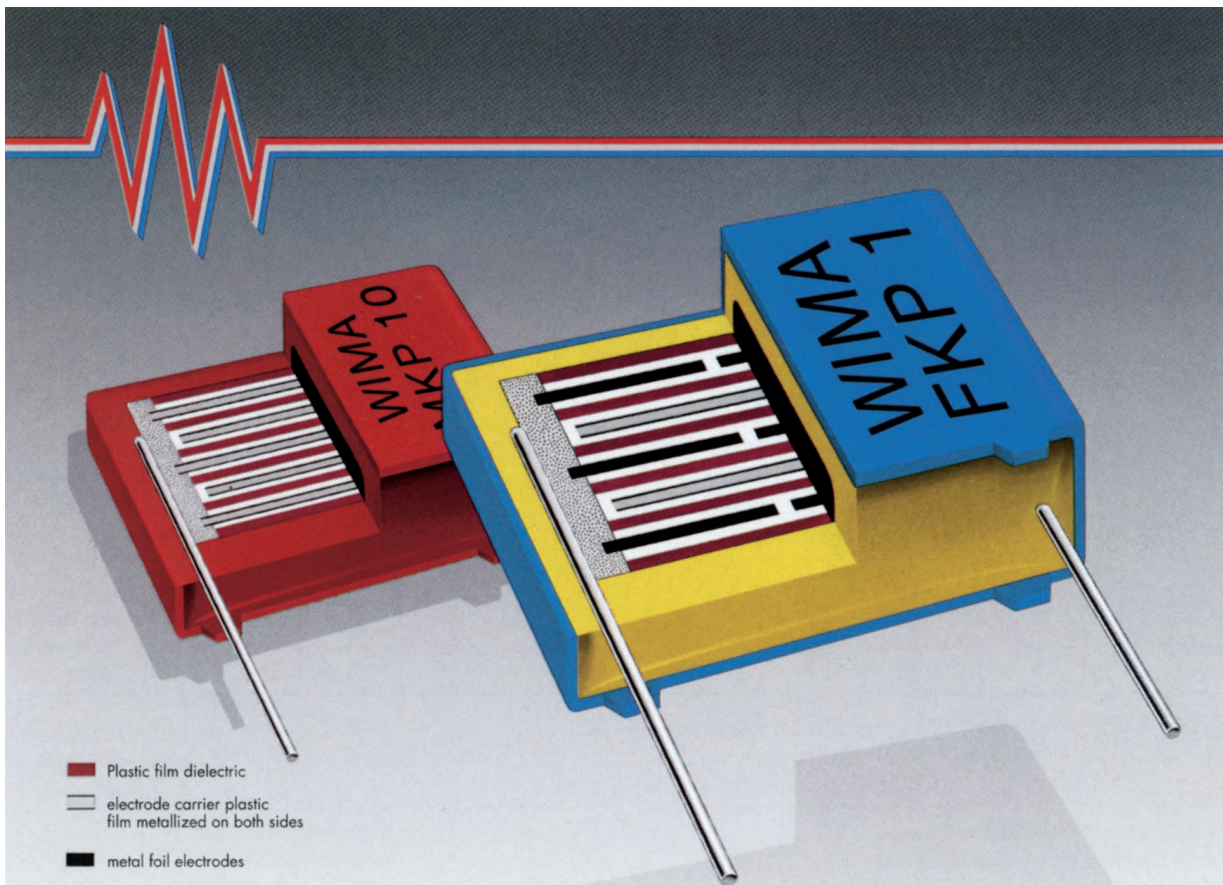

Bei der Herstellung betriebssicherer, ausheilfähiger Impulskondensatoren ist die Strombelastbarkeit der Kontaktierung, d. i. der Übergang zwischen Anschluß und Belag, ein wichtiges Konstruktionskriterium.

■ Für extreme Impulsbelastungen bis zu $18\,000\text{ V}/\mu\text{s}$ wurde die Baureihe **WIMA FKP 1** entwickelt. Sie ist mit einer internen Reihenschaltung realisiert, wobei Beläge aus Metallfolie mit einer beidseitig metallisierten Blindlage kombiniert sind. Die Metallfolienbeläge sind an der Stirnseite flächenhaft kontaktiert. Gleichzeitig ist der Kondensator durch die zweifach metallisierte Blindlage voll ausheilfähig. Der WIMA FKP 1 stellt in puncto Impulsbelastbarkeit das High-End der Kondensatorentechnologie dar.

■ Das Aufbauprinzip der Reihe **WIMA MKP 10** besteht aus einer nicht metallisierten Dielektrikumsfolie und einer doppelseitig metallisierten Belagfolie als Elektrode. Durch Kurzschluß der Metallisierung über die Schoopschicht ist die Belagfolie dielektrisch nicht wirksam. Durch die beidseitige Metallisierung wird die elektrische Leitfähigkeit verbessert und die Kontaktierungsfläche verdoppelt. Die bessere Verbindung zwischen Elektrodenbelag und Schoopschicht erlaubt eine hohe Strom- bzw. Impulsbelastbarkeit. Die Eigenschaften metallisierter Kondensatoren, wie z. B. hervorragende Ausheilfähigkeit und hohe Volumenkapazität, bleiben erhalten.

An important construction criterion in the manufacture of reliable, self-healing capacitors for pulse applications is the current-carrying capacity of the contacts, i. e. the connection between the terminating wires and the electrodes.

■ The **WIMA FKP 1** series was developed for extremely high pulse loads of up to $18\,000\text{ V}/\mu\text{sec}$. It has an internal series connection, the metal foil electrodes being combined with a floating electrode metallized on both sides. The metal foil electrodes are safely contacted on both sides of the end surfaces. At the same time the capacitor is fully self-healing due to the floating electrode metallized on both sides. As regards pulse loading capacity, WIMA FKP 1 represents the high-end of capacitor technology.

■ The construction principle of the series **WIMA MKP 10** consists of a non-metallized dielectric film and an electrode carrier film metallized on both sides acting as electrode. By short-circuiting the metallization over the schoopage, the carrier film is in fieldfree space and is not dielectrically active. Thanks to the metallization on both sides, the electrical conductivity is considerably improved and the contact surface between the electrodes and the schoopage layer is doubled. This results in better contact and allows for high current and pulse loading capacities. The properties of metallized capacitors such as excellent self-healing and high volume capacitance remain unchanged.

WIMA FKP 1

Impulsfeste Polypropylen-Kondensatoren

■ Mit Metallfolienbelägen und innerer Reihenschaltung für höchste Strombelastbarkeit. ■ Einsatzgebiete: Dämpfungs- und Kommutierungs-Kondensator in Schaltnetzteilen, Umrichterschaltungen der Antriebs- und Energietechnik sowie Ablenkschaltungen der Fernseh- und Monitortechnik.

Technische Angaben

Dielektrikum: Polypropylen-Folie.

Beläge: Aluminiumfolie und doppelseitig metallisierte Kunststoff-Folie.

Umhüllung: Flammhemmendes Kunststoffgehäuse, UL 94 V-0, Epoxidharzverguß. Farbe: Blau. Aufdruck: Schwarz.

Temperaturbereich: -55° C bis +100° C.

Prüfklasse: 55/100/56 nach IEC.

Isolationswerte bei +20° C:

$C \leq 0,1 \mu\text{F}$: $\geq 1 \cdot 10^5 \text{ M}\Omega$ (Mittelwert: $5 \cdot 10^5 \text{ M}\Omega$)

$C > 0,1 \mu\text{F}$: $\geq 30\,000 \text{ s (M}\Omega \cdot \mu\text{F)}$ (Mittelwert: 100 000 s)

Meßspannung: 100 V/1 min.

Verlustfaktoren bei +20° C: $\tan \delta$

| Gemessen bei | $C \leq 0,1 \mu\text{F}$ | $0,1 \mu\text{F} < C \leq 0,22 \mu\text{F}$ |
|--------------|--------------------------|---|
| 1 kHz | $\leq 3 \cdot 10^{-4}$ | $\leq 3 \cdot 10^{-4}$ |
| 10 kHz | $\leq 4 \cdot 10^{-4}$ | $\leq 6 \cdot 10^{-4}$ |
| 100 kHz | $\leq 10 \cdot 10^{-4}$ | - |

Kapazitätstoleranzen: $\pm 20\%$, $\pm 10\%$, $\pm 5\%$, andere Toleranzen auf Anfrage.

Impulsbelastung:

| C-Wert pF/ μF | Flankensteilheit V/ μs max. Betrieb | | | | | | | |
|-----------------------------|---|--------|---------|---------|---------|---------|---------|---------|
| | 400 V- | 630 V- | 1000 V- | 1250 V- | 1600 V- | 2000 V- | 4000 V- | 6000 V- |
| 100 ... 220 | - | - | - | - | 18000 | 18000 | - | - |
| 330 ... 680 | - | - | - | - | 15000 | 16000 | 16000 | 16000 |
| 1000 ... 2200 | - | - | - | 13200 | 11000 | 15000 | 15000 | 15000 |
| 3300 ... 6800 | - | 5500 | 10000 | 11200 | 9000 | 13000 | 13000 | 13000 |
| 0,01 ... 0,022 | 2700 | 3300 | 5500 | 7700 | 6000 | 8500 | 8500 | 8500 |
| 0,033 ... 0,068 | 1900 | 2200 | 4200 | 4900 | 3900 | 5000 | 5000 | 5000 |
| 0,1 ... 0,22 | 1200 | 1500 | 2200 | 3100 | 3500 | - | - | - |

Prüfspannung: 2 U_N , 2 s / 6 kV; 1,6 U_N , 2 s.

Schwingen: 6 h bei 10...2000 Hz und 0,75 mm Auslenkung bzw. 10 g nach IEC 60068-2-6.

Unterdruck: 1 kPa = 10 mbar nach IEC 60068-2-13.

Stoßtest: 4000 Stöße mit 390 m/s² nach IEC 60068-2-29.

Spannungsderating: Die zulässige Spannung vermindert sich gegenüber der Nennspannung bei Gleichspannungsbetrieb ab +85° C, bei Wechsellspannungsbetrieb ab +75° C um 1,35% je 1 K.

Kurven siehe Seite 11.

Polypropylene capacitors for pulse applications

■ With metal foil electrode, internally series-connected for very high current ratings. ■ Applications: Damping and commutation capacitors in switch mode power supplies, static frequency changes in drive and power electronics, deflection systems in monitors and TV-sets.

Technical Data

Dielectric: Polypropylene film.

Capacitor electrodes: Aluminium foil and double-sided metallized plastic film.

Encapsulation: Flame-retardent plastic case, UL 94 V-0, with epoxy resin seal. Colour: Blue. Marking: Black.

Temperature range: -55° C to +100° C.

Test category: 55/100/56 in accordance with IEC.

Insulation resistance at +20° C:

$C \leq 0.1 \mu\text{F}$: $\geq 1 \times 10^5 \text{ M}\Omega$ (mean value: $5 \times 10^5 \text{ M}\Omega$)

$C > 0.1 \mu\text{F}$: $\geq 30\,000 \text{ sec (M}\Omega \times \mu\text{F)}$ (mean value: 100 000 sec)

Measuring voltage: 100 V/1 min.

Dissipations factors at +20° C: $\tan \delta$

| at f | $C \leq 0.1 \mu\text{F}$ | $0.1 \mu\text{F} < C \leq 0.22 \mu\text{F}$ |
|---------|--------------------------|---|
| 1 kHz | $\leq 3 \times 10^{-4}$ | $\leq 3 \times 10^{-4}$ |
| 10 kHz | $\leq 4 \times 10^{-4}$ | $\leq 6 \times 10^{-4}$ |
| 100 kHz | $\leq 10 \times 10^{-4}$ | - |

Capacitance tolerances: $\pm 20\%$, $\pm 10\%$, $\pm 5\%$ (closer tolerances are available subject to special enquiry).

Maximum pulse rise time:

| Capacitance pF/ μF | Pulse rise time V/ μsec max. operation | | | | | | | |
|----------------------------------|--|---------|----------|----------|----------|----------|----------|----------|
| | 400 VDC | 630 VDC | 1000 VDC | 1250 VDC | 1600 VDC | 2000 VDC | 4000 VDC | 6000 VDC |
| 100 ... 220 | - | - | - | - | 18000 | 18000 | - | - |
| 330 ... 680 | - | - | - | - | 15000 | 16000 | 16000 | 16000 |
| 1000 ... 2200 | - | - | - | 13200 | 11000 | 15000 | 15000 | 15000 |
| 3300 ... 6800 | - | 5500 | 10000 | 11200 | 9000 | 13000 | 13000 | 13000 |
| 0.01 ... 0.022 | 2700 | 3300 | 5500 | 7700 | 6000 | 8500 | 8500 | 8500 |
| 0.033 ... 0.068 | 1900 | 2200 | 4200 | 4900 | 3900 | 5000 | 5000 | 5000 |
| 0.1 ... 0.22 | 1200 | 1500 | 2200 | 3100 | 3500 | - | - | - |

Test voltage: 2 Ur, 2 sec / 6000 VDC; 1.6 Ur, 2 sec.

Vibration: 6 hours at 10...2000 Hz and 0.75 mm displacement amplitude or 10 g in accordance with IEC 60068-2-6.

Low air density: 1 kPa = 10 mbar in accordance with IEC 60068-2-13.

Bump test: 4000 bumps at 390 m/s² in accordance with IEC 60068-2-29.

Voltage derating: A voltage derating factor of 1.35% per K must be applied from +85° C for DC voltages and from +75° C for AC voltages.

Graphs see page 11.

Werteübersicht / General Data

| Kapazität Capacitance | 400 VDC/250 VAC* | | | | 630 VDC/400 VAC* | | | | 1000 VDC/600 VAC* | | | | 1250 VDC/600 VAC** | | | |
|--------------------------|------------------|------|------|-------|------------------|------|------|-------|-------------------|------|------|-------|--------------------|------|------|-------|
| | W | H | L | PCM** | W | H | L | PCM** | W | H | L | PCM** | W | H | L | PCM** |
| 1000 pF | | | | | | | | | | | | | 5 | 11 | 18 | 15 |
| 1500 „ | | | | | | | | | | | | | 5 | 11 | 18 | 15 |
| 2200 „ | | | | | | | | | | | | | 5 | 11 | 18 | 15 |
| 3300 „ | | | | | | | | | 5 | 11 | 18 | 15 | 6 | 12.5 | 18 | 15 |
| 4700 „ | | | | | 5 | 11 | 18 | 15 | 6 | 12.5 | 18 | 15 | 7 | 14 | 18 | 15 |
| 6800 „ | | | | | 6 | 12.5 | 18 | 15 | 7 | 14 | 18 | 15 | 8 | 15 | 18 | 15* |
| | | | | | | | | | | | | | 5 | 14 | 26.5 | 22.5* |
| 0.01 µF | 5 | 11 | 18 | 15 | 7 | 14 | 18 | 15* | 8 | 15 | 18 | 15* | 7 | 16.5 | 26.5 | 22.5 |
| | | | | | 5 | 14 | 26.5 | 22.5* | 6 | 15 | 26.5 | 22.5* | | | | |
| 0.015 „ | 6 | 12.5 | 18 | 15 | 8 | 15 | 18 | 15* | 6 | 15 | 26.5 | 22.5 | 8.5 | 18.5 | 26.5 | 22.5 |
| | | | | | 6 | 15 | 26.5 | 22.5* | | | | | | | | |
| 0.022 „ | 7 | 14 | 18 | 15* | 7 | 16.5 | 26.5 | 22.5 | 8.5 | 18.5 | 26.5 | 22.5 | 10.5 | 20.5 | 26.5 | 22.5 |
| | 5 | 14 | 26.5 | 22.5* | | | | | | | | | | | | |
| 0.033 „ | 8 | 15 | 18 | 15* | 8.5 | 18.5 | 26.5 | 22.5 | 10.5 | 20.5 | 26.5 | 22.5* | 11 | 21 | 31.5 | 27.5* |
| | 6 | 15 | 26.5 | 22.5* | | | | | 9 | 19 | 31.5 | 27.5* | 9 | 19 | 41.5 | 37.5* |
| 0.047 „ | 7 | 16.5 | 26.5 | 22.5 | 10.5 | 20.5 | 26.5 | 22.5* | 11 | 21 | 31.5 | 27.5 | 13 | 24 | 31.5 | 27.5* |
| | | | | | 9 | 19 | 31.5 | 27.5* | | | | | 11 | 22 | 41.5 | 37.5* |
| 0.068 „ | 8.5 | 18.5 | 26.5 | 22.5 | 11 | 21 | 31.5 | 27.5* | 13 | 24 | 31.5 | 27.5* | 11 | 22 | 41.5 | 37.5 |
| | | | | | 9 | 19 | 41.5 | 37.5* | 11 | 22 | 41.5 | 37.5* | | | | |
| 0.1 µF | 10.5 | 20.5 | 26.5 | 22.5* | 13 | 24 | 31.5 | 27.5* | 13 | 24 | 41.5 | 37.5 | 15 | 26 | 41.5 | 37.5 |
| | 9 | 19 | 31.5 | 27.5* | 11 | 22 | 41.5 | 37.5* | | | | | | | | |
| 0.15 „ | 11 | 21 | 31.5 | 27.5 | 13 | 24 | 41.5 | 37.5 | 15 | 26 | 41.5 | 37.5 | 17 | 29 | 41.5 | 37.5 |
| 0.22 „ | 13 | 24 | 31.5 | 27.5 | 15 | 26 | 41.5 | 37.5 | 19 | 32 | 41.5 | 37.5 | 19 | 32 | 41.5 | 37.5 |

* Wechselspannungen: $f \leq 1000 \text{ Hz}$; $1,4 \cdot U_{\text{eff}} \sim + U_- \leq U_N$

* AC voltage: $f \leq 1000 \text{ Hz}$; $1,4 \times U_{\text{rms}} + U_{\text{DC}} \leq U_r$

** PCM = Printed circuit module = Rastermaß

** PCM = Printed circuit module = lead spacing

Die Ionisationseinsatzgrenze kann im Einzelfall unter der Wechselspannungsangabe liegen.
Ionisation inception level in isolated cases may be lower than admissible rated AC voltage

Zwischenwerte auf Anfrage
Other values available subject to special enquiry.

- * Bei Bestellung bitte das gewünschte Rastermaß angeben.
Wenn keine Angaben erfolgen, wird grundsätzlich das kleinere RM geliefert.
- * On ordering please state the required PCM (lead spacing).
If not specified, smaller PCM will be booked.

Alle Maße in mm. / Dims. in mm.

Gegurtete Ausführung siehe Seite 76.
Taped version see page 76.

Abweichungen und Konstruktionsänderungen vorbehalten.
Rights reserved to amend design data without prior notification.

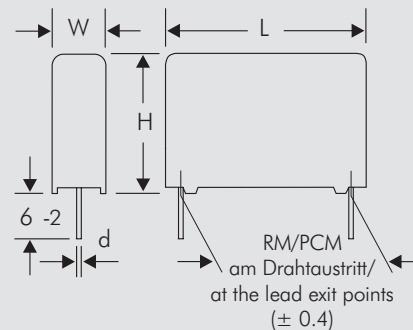

$d = 0.8 \text{ } \varnothing$ if PCM 15 ... 27.5
 $d = 1.0 \text{ } \varnothing$ if PCM 37.5

Fortsetzung Seite 59. / Continuation page 59.

WIMA FKP 1

Werteübersicht / General Data

| Kapazität Capacitance | 1600 VDC/650 VAC* | | | | 2000 VDC/700 VAC* | | | | 4000 VDC/700 VAC* | | | | 6000 VDC/700 VAC* | | | |
|--------------------------|-------------------|------|------|-------|-------------------|------|------|-------|-------------------|------|------|-------|-------------------|------|------|-------|
| | W | H | L | PCM** | W | H | L | PCM** | W | H | L | PCM** | W | H | L | PCM** |
| 100 pF | 5 | 11 | 18 | 15 | 5 | 11 | 18 | 15 | | | | | | | | |
| 150 „ | 5 | 11 | 18 | 15 | 5 | 11 | 18 | 15 | | | | | | | | |
| 220 „ | 5 | 11 | 18 | 15 | 5 | 11 | 18 | 15 | | | | | | | | |
| 330 „ | 5 | 11 | 18 | 15 | 6 | 12.5 | 18 | 15 | | | | | | | | |
| 470 „ | 5 | 11 | 18 | 15 | 6 | 12.5 | 18 | 15 | 5 | 14 | 26.5 | 22.5 | 5 | 14 | 26.5 | 22.5 |
| 680 „ | 5 | 11 | 18 | 15 | 6 | 12.5 | 18 | 15 | 5 | 14 | 26.5 | 22.5 | 5 | 14 | 26.5 | 22.5 |
| 1000 pF | 6 | 12.5 | 18 | 15* | 7 | 14 | 18 | 15* | 5 | 14 | 26.5 | 22.5 | 5 | 14 | 26.5 | 22.5 |
| 1500 „ | 5 | 14 | 26.5 | 22.5* | 5 | 14 | 26.5 | 22.5* | 7 | 16.5 | 26.5 | 22.5 | 7 | 16.5 | 26.5 | 22.5 |
| 2200 „ | 7 | 14 | 18 | 15* | 6 | 15 | 26.5 | 22.5 | 8.5 | 18.5 | 26.5 | 22.5 | 10.5 | 20.5 | 26.5 | 22.5 |
| 3300 „ | 5 | 14 | 26.5 | 22.5* | 7 | 16.5 | 26.5 | 22.5 | 10.5 | 20.5 | 26.5 | 22.5 | 10.5 | 20.5 | 26.5 | 22.5 |
| 4700 „ | 8 | 15 | 18 | 15* | 7 | 16.5 | 26.5 | 22.5 | 11 | 21 | 31.5 | 27.5 | 11 | 21 | 31.5 | 27.5 |
| 6800 „ | 5 | 14 | 26.5 | 22.5* | 8.5 | 18.5 | 26.5 | 22.5 | 13 | 24 | 31.5 | 27.5 | 13 | 24 | 31.5 | 27.5 |
| 0.01 µF | 10.5 | 20.5 | 26.5 | 27.5 | 11 | 21 | 31.5 | 27.5 | 15 | 26 | 31.5 | 27.5 | 15 | 26 | 31.5 | 27.5 |
| 0.015 „ | 11 | 21 | 31.5 | 27.5 | 13 | 24 | 31.5 | 27.5 | 13 | 24 | 41.5 | 37.5 | 13 | 24 | 41.5 | 37.5 |
| 0.022 „ | 11 | 21 | 31.5 | 27.5 | 15 | 26 | 31.5 | 27.5* | 17 | 29 | 41.5 | 37.5 | 17 | 29 | 41.5 | 37.5 |
| 0.033 „ | | | | | 13 | 24 | 41.5 | 37.5* | | | | | | | | |
| 0.047 „ | 13 | 24 | 31.5 | 27.5* | 13 | 24 | 41.5 | 37.5 | | | | | | | | |
| 0.068 „ | 13 | 24 | 41.5 | 37.5* | 17 | 29 | 41.5 | 37.5 | | | | | | | | |
| 0.1 µF | 15 | 26 | 41.5 | 37.5 | | | | | | | | | | | | |

* Bei Bestellung bitte das gewünschte Rastermaß angeben. Wenn keine Angaben erfolgen, wird grundsätzlich das kleinere RM geliefert.
* On ordering please state the required PCM (lead spacing). If not specified, smaller PCM will be booked.

Neue Bauformen. / New box sizes.

* Wechselspannungen: $f \leq 1000 \text{ Hz}$; $1,4 \cdot U_{\text{eff}} \sim + U_{-} \leq U_N$

* AC voltage: $f \leq 1000 \text{ Hz}$; $1,4 \times U_{\text{rms}} + U_{\text{DC}} \leq U_r$

** PCM = Printed circuit module = Rastermaß/lead spacing

Die Ionisationseinsatzgrenze kann im Einzelfall unter der Wechselspannungsangabe liegen.
Ionisation inception level in isolated cases may be lower than admissible rated AC voltage.

$d = 0,8 \phi$ if PCM 15 ... 27.5
 $d = 1,0 \phi$ if PCM 37.5

Gegurtete Ausführung siehe Seite 76. / Taped version see page 76.

Abweichungen und Konstruktionsänderungen vorbehalten.
Rights reserved to amend design data without prior notification.

Alle Maße in mm. / Dims. in mm.

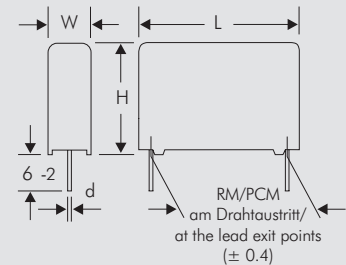

Zulässige Wechselspannung in Abhängigkeit von der Frequenz bei 10° C Eigenerwärmung (Richtwerte):
Permissible AC voltage in relation to frequency at 10° C internal temperature rise (general guide):

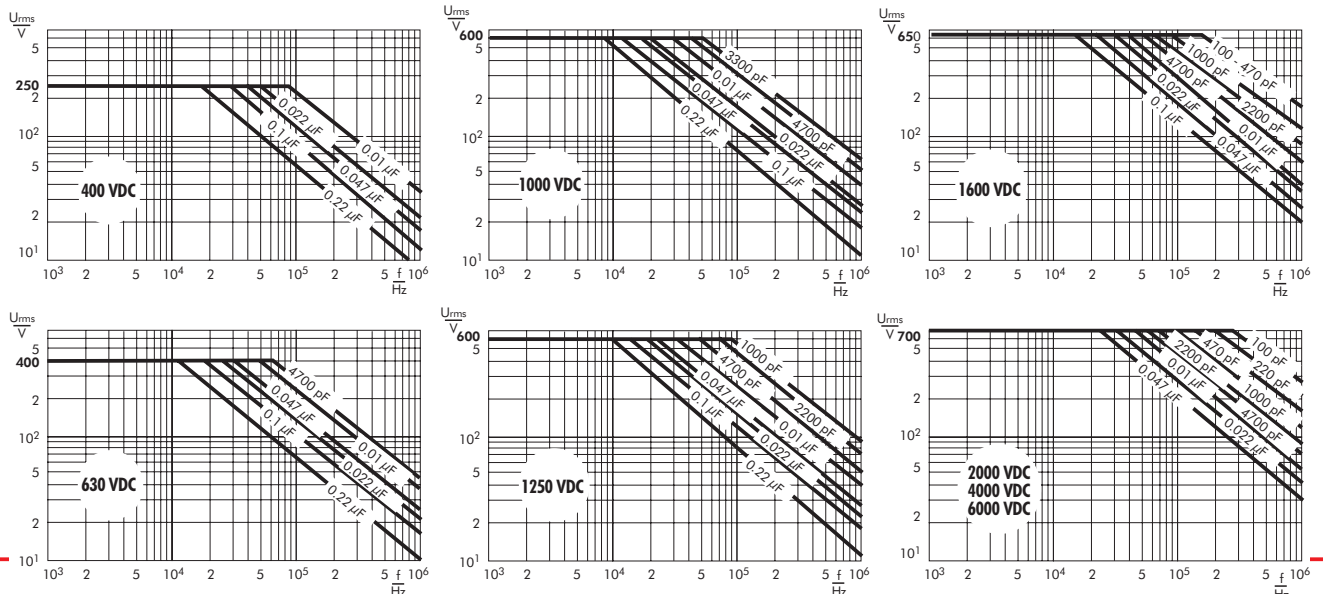

WIMA MKP 10

Impulsfeste Polypropylen-Kondensatoren

■ Für Anwendungen in Schaltnetzteilen, in der Beleuchtungs-, Fernseh- und Monitortechnik sowie für Lautsprecherweichen. ■ Impulsfester und ausheilfähiger Aufbau mit doppelseitig metallisierter Belagfolie (siehe Seite 63).

Technische Angaben

Dielektrikum: Polypropylen-Folie.

Beläge: Doppelseitig metallisierte Kunststoff-Folie.

Umhüllung: Flammhemmendes Kunststoffgehäuse, UL 94 V-0, Epoxidharzverguß. Farbe: Rot. Aufdruck: Schwarz.

Temperaturbereich: -55° C bis +100° C.

Prüfklasse: 55/100/56 nach IEC.

Isolationswerte bei +20° C:

$C \leq 0,33 \mu\text{F}$: $\geq 1 \cdot 10^5 \text{ M}\Omega$ (Mittelwert: $5 \cdot 10^5 \text{ M}\Omega$)

$C > 0,33 \mu\text{F}$: $\geq 30\,000 \text{ s (M}\Omega \cdot \mu\text{F)}$ (Mittelwert: 100\,000 s)

Meßspannung: 100 V/1 min.

Verlustfaktoren bei +20° C: $\tan \delta$

| Gemessen bei | $C \leq 0,1 \mu\text{F}$ | $0,1 \mu\text{F} < C \leq 1,0 \mu\text{F}$ | $C > 1,0 \mu\text{F}$ |
|--------------|--------------------------|--|------------------------|
| 1 kHz | $\leq 3 \cdot 10^{-4}$ | $\leq 3 \cdot 10^{-4}$ | $\leq 3 \cdot 10^{-4}$ |
| 10 kHz | $\leq 4 \cdot 10^{-4}$ | $\leq 6 \cdot 10^{-4}$ | - |
| 100 kHz | $\leq 15 \cdot 10^{-4}$ | - | - |

Kapazitätstoleranzen: $\pm 20\%$, $\pm 10\%$, $\pm 5\%$.

Impulsbelastung:

| C-Wert pF/ μF | Flankensteilheit V/ μs max. Betrieb | | | | | |
|-----------------------------|---|--------|--------|--------|---------|--------------------|
| | 160 V- | 250 V- | 400 V- | 630 V- | 1000 V- | 1600 V- 2000 V- |
| 1000 ... 2200 | - | - | - | 1000 | 1800 | 3000 |
| 3300 ... 6800 | - | - | 600 | 950 | 1300 | 1500 |
| 0,01 ... 0,022 | - | 400 | 420 | 950 | 950 | 1000 |
| 0,033 ... 0,068 | 200 | 150 | 200 | 600 | 700 | 700 |
| 0,1 ... 0,22 | 110 | 130 | 130 | 350 | 430 | 430 |
| 0,33 ... 0,68 | 70 | 85 | 100 | 250 | 300 | 300 |
| 1,0 ... 2,2 | 55 | 65 | 75 | 150 | 200 | 250 |
| 3,3 ... 4,7 | 40 | 65 | 75 | 150 | - | - |
| 6,8 ... 10 | 30 | 35 | - | - | - | - |

Prüfspannung: $1,6 U_N$ 2 s.

Schwingen: 6 h bei 10...2000 Hz und 0,75 mm Auslenkung bzw. 10 g nach IEC 60068-2-6.

Unterdruck: 1 kPa = 10 mbar nach IEC 60068-2-13.

Stoßtest: 4000 Stöße mit 390 m/s² nach IEC 60068-2-29.

Spannungsderating: Die zulässige Spannung vermindert sich gegenüber der Nennspannung bei Gleichspannungsbetrieb ab +85° C, bei Wechselspannungsbetrieb ab +75° C um 1,35% je 1 K.

Kurven siehe Seite 7.

Polypropylene capacitors for pulse applications

■ For applications in switch mode power supplies, frequency dividing in loudspeakers, in lighting, monitors and TV-sets. ■ Self-healing pulse duty construction with electrodes of double-sided metallized carrier film (see page 63).

Technical Data

Dielectric: Polypropylene film.

Capacitor electrodes: Double-sided metallized plastic film.

Encapsulation: Flame-retardent plastic case, UL 94 V-0, with epoxy resin seal. Colour: Red. Marking: Black.

Temperature range: -55° C to +100° C.

Test category: 55/100/56 in accordance with IEC.

Insulation resistance at +20° C:

$C \leq 0,33 \mu\text{F}$: $\geq 1 \times 10^5 \text{ M}\Omega$ (mean value: $5 \times 10^5 \text{ M}\Omega$)

$C > 0,33 \mu\text{F}$: $\geq 30\,000 \text{ sec (M}\Omega \times \mu\text{F)}$ (mean value: 100\,000 sec)

Measuring voltage: 100 V/1 min.

Dissipation factors at +20° C: $\tan \delta$

| at f | $C \leq 0,1 \mu\text{F}$ | $0,1 \mu\text{F} < C \leq 1,0 \mu\text{F}$ | $C > 1,0 \mu\text{F}$ |
|---------|--------------------------|--|-------------------------|
| 1 kHz | $\leq 3 \times 10^{-4}$ | $\leq 3 \times 10^{-4}$ | $\leq 3 \times 10^{-4}$ |
| 10 kHz | $\leq 4 \times 10^{-4}$ | $\leq 6 \times 10^{-4}$ | - |
| 100 kHz | $\leq 15 \times 10^{-4}$ | - | - |

Capacitance tolerances: $\pm 20\%$, $\pm 10\%$, $\pm 5\%$.

Maximum pulse rise time:

| Capacitance pF/ μF | Pulse rise time V/ μsec max. operation | | | | | |
|----------------------------------|--|---------|---------|---------|----------|----------------------|
| | 160 VDC | 250 VDC | 400 VDC | 630 VDC | 1000 VDC | 1600 VDC 2000 VDC |
| 1000 ... 2200 | - | - | - | 1000 | 1800 | 3000 |
| 3300 ... 6800 | - | - | 600 | 950 | 1300 | 1500 |
| 0,01 ... 0,022 | - | 400 | 420 | 950 | 950 | 1000 |
| 0,033 ... 0,068 | 200 | 150 | 200 | 600 | 700 | 700 |
| 0,1 ... 0,22 | 110 | 130 | 130 | 350 | 430 | 430 |
| 0,33 ... 0,68 | 70 | 85 | 100 | 250 | 300 | 300 |
| 1,0 ... 2,2 | 55 | 65 | 75 | 150 | 200 | 250 |
| 3,3 ... 4,7 | 40 | 65 | 75 | 150 | - | - |
| 6,8 ... 10 | 30 | 35 | - | - | - | - |

Test voltage: $1,6 U_r$, 2 sec.

Vibration: 6 hours at 10...2000 Hz and 0,75 mm displacement amplitude or 10 g in accordance with IEC 60068-2-6.

Low air density: 1 kPa = 10 mbar in accordance with IEC 60068-2-13.

Bump test: 4000 bumps at 390 m/sec² in accordance with IEC 60068-2-29.

Voltage derating: A voltage derating factor of 1.35% per K must be applied from +85° C for DC voltages and from +75° C for AC voltages.

Graphs see page 7.

Werteübersicht / General Data

| Kapazität Capacitance | 160 VDC/100 VAC* | | | | 250 VDC/180 VAC* | | | | 400 VDC/250 VAC* | | | | 630 VDC/400 VAC* | | | |
|--------------------------|------------------|------|------|-------|------------------|------|------|------------|------------------|------|------|------------|------------------|------|------|--------------|
| | W | H | L | PCM** | W | H | L | PCM** | W | H | L | PCM** | W | H | L | PCM** |
| 1000 pF | | | | | | | | | | | | | 4 | 9 | 10 | 7.5** |
| 1500 „ | | | | | | | | | | | | | 4 | 9 | 10 | 7.5** |
| 2200 „ | | | | | | | | | | | | | 4 | 9 | 10 | 7.5** |
| 3300 „ | | | | | | | | | | | | | 4 | 9 | 10 | 7.5** |
| 4700 „ | | | | | | | | | | | | | 4 | 9 | 10 | 7.5** |
| 6800 „ | | | | | | | | | 4 | 9 | 10 | 7.5 | 4 | 9 | 13 | 10 |
| 0.01 µF | | | | | | | | | 4 | 9 | 10 | 7.5 | 4 | 9 | 13 | 10 |
| 0.015 „ | | | | | 4 | 9 | 10 | 7.5 | 4 | 9 | 13 | 10 | 5 | 11 | 13 | 10 |
| 0.022 „ | | | | | 4 | 9 | 10 | 7.5 | 4 | 9.5 | 13 | 10 | 6 | 12.5 | 13 | 10 |
| 0.033 „ | 4 | 9 | 13 | 10 | 4 | 9.5 | 13 | 10 | 5 | 11 | 13 | 10 | 5 | 11 | 18 | 15 |
| 0.047 „ | 4 | 9.5 | 13 | 10 | 5 | 11 | 13 | 10 | 5 | 11 | 18 | 15 | 6 | 12.5 | 18 | 15 |
| 0.068 „ | 5 | 11 | 13 | 10 | 6 | 12.5 | 13 | 10 | 6 | 12.5 | 18 | 15 | 7 | 14 | 18 | 15 |
| 0.1 µF | 6 | 12.5 | 13 | 10 | 5 | 11 | 18 | 15 | 7 | 14 | 18 | 15 | 7 | 16.5 | 26.5 | 22.5 |
| 0.15 „ | 6 | 12.5 | 18 | 15 | 6 | 12.5 | 18 | 15 | 8 | 15 | 18 | 15 | 8.5 | 18.5 | 26.5 | 22.5 |
| 0.22 „ | 7 | 14 | 18 | 15 | 7 | 14 | 18 | 15 | 7 | 16.5 | 26.5 | 22.5 | 10.5 | 19 | 26.5 | 22.5 |
| 0.33 „ | 8 | 15 | 18 | 15 | 8 | 15 | 18 | 15 | 8.5 | 18.5 | 26.5 | 22.5 | 11 | 21 | 26.5 | 22.5 |
| 0.47 „ | 7 | 16.5 | 26.5 | 22.5 | 7 | 16.5 | 26.5 | 22.5 | 10.5 | 19 | 26.5 | 22.5 | 11 | 21 | 31.5 | 27.5 |
| 0.68 „ | 8.5 | 18.5 | 26.5 | 22.5 | 8.5 | 18.5 | 26.5 | 22.5 | 11 | 21 | 31.5 | 27.5 | 15 | 26 | 31.5 | 27.5 |
| 1.0 µF | 10.5 | 19 | 26.5 | 22.5 | 11 | 21 | 26.5 | 22.5 | 13 | 24 | 31.5 | 27.5 | 17 | 29 | 31.5 | 27.5 |
| 1.5 „ | 11 | 21 | 31.5 | 27.5 | 13 | 24 | 31.5 | 27.5 | 17 | 29 | 31.5 | 27.5 | 19 | 32 | 41.5 | 37.5 |
| 2.2 „ | 13 | 24 | 31.5 | 27.5 | 15 | 26 | 31.5 | 27.5 | 17 | 29 | 41.5 | 37.5 | 20 | 39.5 | 41.5 | 37.5 |
| 3.3 „ | 17 | 29 | 31.5 | 27.5 | 17 | 34.5 | 31.5 | 27.5 | 20 | 39.5 | 41.5 | 37.5 | 24 | 45.5 | 41.5 | 37.5 |
| 4.7 „ | 17 | 29 | 41.5 | 37.5 | 19 | 32 | 41.5 | 37.5 | 24 | 45.5 | 41.5 | 37.5 | | | | |
| 6.8 „ | 20 | 39.5 | 41.5 | 37.5 | 20 | 39.5 | 41.5 | 37.5 | | | | | | | | |
| 10 µF | 24 | 45.5 | 41.5 | 37.5 | | | | | | | | | | | | |

* Wechselspannungen: $f \leq 1000 \text{ Hz}$; $1,4 \cdot U_{\text{eff}} \sim + U_- \leq U_N$
 * AC voltage: $f \leq 1000 \text{ Hz}$; $1,4 \times U_{\text{rms}} + U_{\text{DC}} \leq U_r$

** Zulässige Nennwechselspannung max. 280 V~
 ** Admissible AC voltage 280 VAC max.

** PCM = Printed circuit module = Rastermaß
 ** PCM = Printed circuit module = lead spacing

Alle Maße in mm.
 Dims. in mm.

Die Ionisationseinsatzgrenze kann im Einzelfall unter der Wechselspannungsangabe liegen.
 Ionisation inception level in isolated cases may be lower than admissible rated AC voltage

Die Kondensatoren der Reihe mit 400 V~ sind in Serienschaltung ausgeführt.
 The capacitors of the 400 VAC range are series-connected.

Gegurtete Ausführung siehe Seite 76.
 Taped version see page 76.

Abweichungen und Konstruktionsänderungen vorbehalten.
 Rights reserved to amend design data without prior notification.

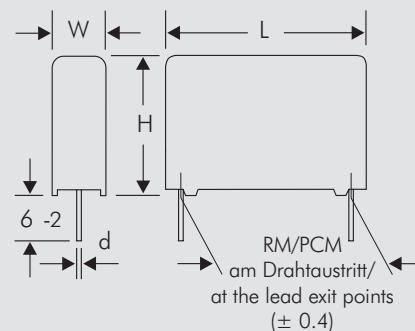

| ∅ d | PCM | W |
|-----|---------|------|
| 0.7 | 7.5 | |
| 0.7 | 10 | |
| 0.8 | 15-22.5 | |
| 0.8 | 27.5 | ≤ 15 |
| 1.0 | 27.5 | > 15 |
| 1.0 | 37.5 | |

Fortsetzung Seite 62. / Continuation page 62.

WIMA MKP 10

Werteübersicht / General Data

| Kapazität Capacitance | 1000 VDC/600 VAC* | | | | 1600 VDC/650 VAC* | | | | 2000 VDC/700 VAC* | | | |
|--------------------------|-------------------|------|------|-------|-------------------|------|------|-------|-------------------|------|------|-------|
| | W | H | L | PCM** | W | H | L | PCM** | W | H | L | PCM** |
| 1000 pF | 4 | 9 | 13 | 10 | 4 | 9 | 13 | 10 | 4 | 9 | 13 | 10 |
| 1500 " | 4 | 9 | 13 | 10 | 4 | 9 | 13 | 10 | 4 | 9.5 | 13 | 10 |
| 2200 " | 4 | 9 | 13 | 10 | 4 | 9 | 13 | 10 | 5 | 11 | 13 | 10 |
| 3300 " | 4 | 9 | 13 | 10 | 4 | 9.5 | 13 | 10 | 5 | 11 | 18 | 15 |
| 4700 " | 4 | 9.5 | 13 | 10 | 5 | 11 | 13 | 10 | 5 | 11 | 18 | 15 |
| 6800 " | 5 | 11 | 13 | 10 | 6 | 12.5 | 13 | 10 | 6 | 12.5 | 18 | 15 |
| 0.01 µF | 5 | 11 | 13 | 10 | 5 | 11 | 18 | 15 | 7 | 14 | 18 | 15 |
| 0.015 " | 5 | 11 | 18 | 15 | 6 | 12.6 | 18 | 15 | 8 | 15 | 18 | 15 |
| 0.022 " | 6 | 12.5 | 18 | 15 | 7 | 14 | 18 | 15 | 7 | 16.5 | 26.5 | 22.5 |
| 0.033 " | 7 | 14 | 18 | 15 | 7 | 16.5 | 26.5 | 22.5 | 8.5 | 18.5 | 26.5 | 22.5 |
| 0.047 " | 8 | 15 | 18 | 15 | 8.5 | 18.5 | 26.5 | 22.5 | 10.5 | 19 | 26.5 | 22.5 |
| 0.068 " | 7 | 16.5 | 26.5 | 22.5 | 10.5 | 19 | 26.5 | 22.5 | 11 | 21 | 26.5 | 22.5 |
| 0.1 µF | 8.5 | 18.5 | 26.5 | 22.5 | 11 | 21 | 26.5 | 22.5 | 13 | 24 | 31.5 | 27.5 |
| 0.15 " | 11 | 21 | 26.5 | 22.5 | 13 | 24 | 31.5 | 27.5 | 15 | 26 | 31.5 | 27.5 |
| 0.22 " | 11 | 21 | 31.5 | 27.5 | 15 | 26 | 31.5 | 27.5 | 17 | 34.5 | 31.5 | 27.5 |
| 0.33 " | 15 | 26 | 31.5 | 27.5 | 17 | 34.5 | 31.5 | 27.5 | 19 | 32 | 41.5 | 37.5 |
| 0.47 " | 17 | 29 | 31.5 | 27.5 | 19 | 32 | 41.5 | 37.5 | 20 | 39.5 | 41.5 | 37.5 |
| 0.68 " | 17 | 29 | 41.5 | 37.5 | 20 | 39.5 | 41.5 | 37.5 | 24 | 45.5 | 41.5 | 37.5 |
| 1.0 µF | 20 | 39.5 | 41.5 | 37.5 | 24 | 45.5 | 41.5 | 37.5 | | | | |
| 1.5 " | 24 | 45.5 | 41.5 | 37.5 | | | | | | | | |

* Wechselspannungen: $f \leq 1000 \text{ Hz}$; $1,4 \cdot U_{\text{eff}} \sim + U_- \leq U_N$

* AC voltage: $f \leq 1000 \text{ Hz}$; $1,4 \times U_{\text{rms}} + U_{\text{DC}} \leq U_r$

** PCM = Printed circuit module = Rastermaß

** PCM = Printed circuit module = lead spacing

Alle Maße in mm. / Dims. in mm.

Die Ionisationseinsatzgrenze kann im Einzelfall unter der Wechselspannungsangabe liegen.

Ionisation inception level in isolated cases may be lower than admissible rated AC voltage

Die Kondensatoren der Reihe mit 600 V~ , 650 V~ und 700 V~ sind in Serienschaltung ausgeführt.

The capacitors of the 600 VAC, 650 VAC and 700 VAC ranges are series-connected.

Gegurtete Ausführung siehe Seite 76.

Taped version see page 76.

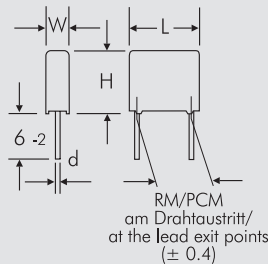

| ø d | PCM | W |
|-----|---------|------|
| 0.7 | 7.5 | |
| 0.7 | 10 | |
| 0.8 | 15-22.5 | |
| 0.8 | 27.5 | ≤ 15 |
| 1.0 | 27.5 | > 15 |
| 1.0 | 37.5 | |

Abweichungen und Konstruktionsänderungen vorbehalten.
Rights reserved to amend design data without prior notification.

Zulässige Wechselspannung in Abhängigkeit von der Frequenz bei 10° C Eigenerwärmung (Richtwerte):
Permissible AC voltage in relation to frequency at 10° C internal temperature rise (general guide):

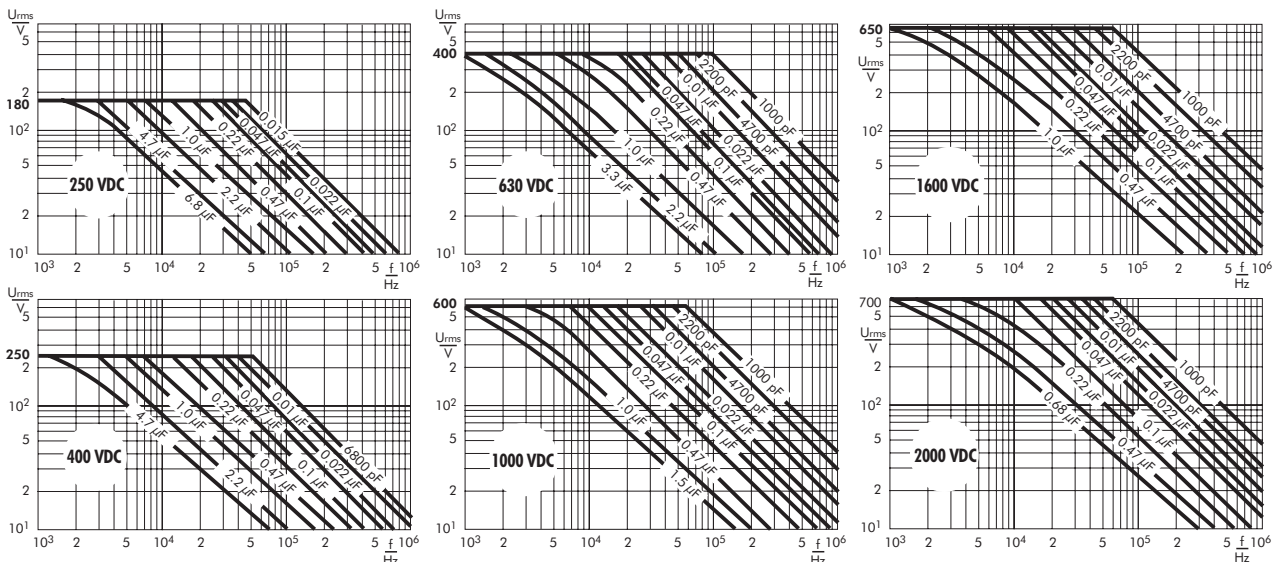

Konstruktionsarten betriebs sicherer und ausheil- fähiger Impulskondensatoren

Types of construction of operationally safe self- healing pulse capacitors

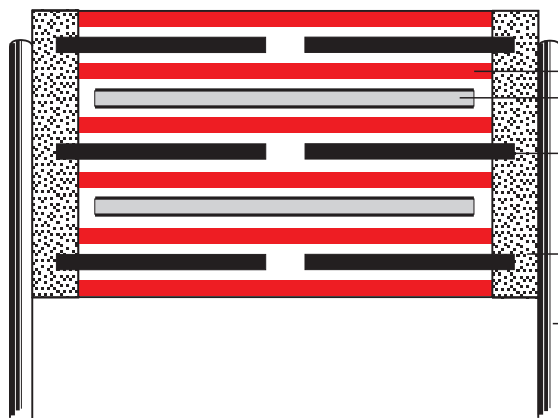

FKP 1

- Kunststofffolien-Dielektrikum
Plastic film dielectric
- Doppelseitig metallisierter Belagträger aus Kunststoffolie
Electrode carrier plastic film metallized on both sides
- Metallfolien-Beläge
Aluminium foil electrodes
- Kontaktschicht (Schoopmetall)
Metal contact layer (schoopage)
- Anschlußdraht
Terminating wire

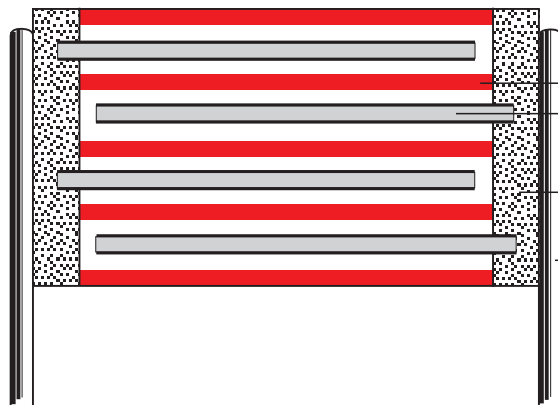

MKP 10 *

- Kunststofffolien-Dielektrikum
Plastic film dielectric
- Doppelseitig metallisierter Belagträger aus Kunststoffolie
Electrode carrier plastic film metallized on both sides
- Kontaktschicht (Schoopmetall)
Metal contact layer (schoopage)
- Anschlußdraht
Terminating wire

*MKP 10: 100 VAC, 180 VAC, 250 VAC

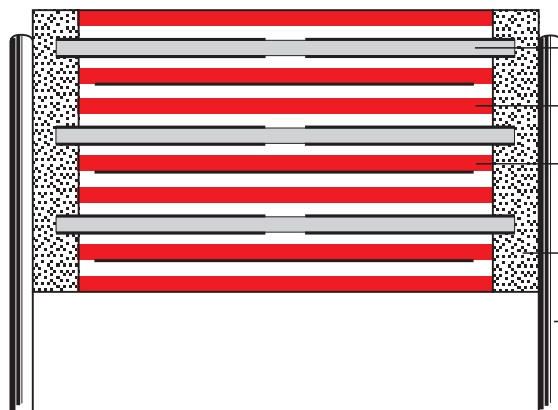

MKP 10 *

Snubber MKP

- Doppelseitig metallisierter Belagträger aus Kunststoffolie
Electrode carrier plastic film metallized on both sides
- Kunststofffolien-Dielektrikum
Plastic film dielectric
- Einseitig metallisierter Belagträger aus Kunststoffolie
Electrode carrier plastic film with metal electrode
- Kontaktschicht (Schoopmetall)
Metal contact layer (schoopage)
- Anschlußdraht
Terminating wire

*MKP 10: 400 VAC, 600 VAC, 650 VAC, 700 VAC

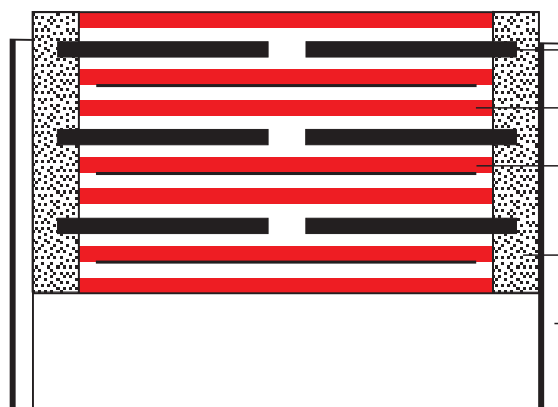

Snubber FKP

- Metallfolien-Beläge
Metal foil electrodes
- Kunststofffolien-Dielektrikum
Plastic film dielectric
- Einseitig metallisierter Belagträger aus Kunststoffolie
Electrode carrier plastic film with metal electrode
- Kontaktschicht (Schoopmetall)
Metal contact layer (schoopage)
- Anschlußblase
Terminating tab

Typical dimensions for taping configuration

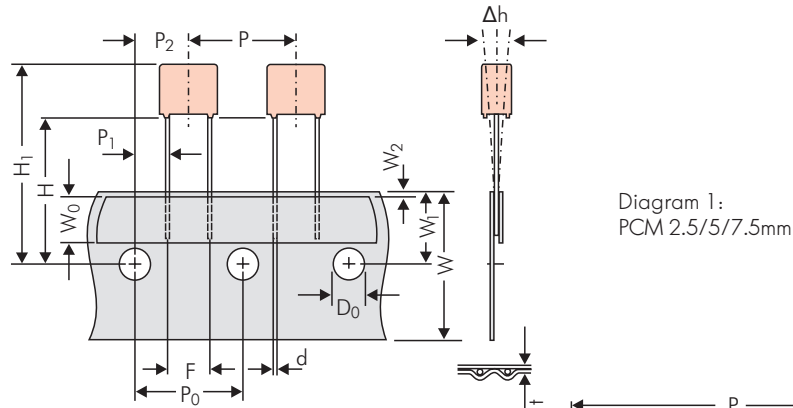

Diagram 1:
PCM 2.5/5/7.5mm

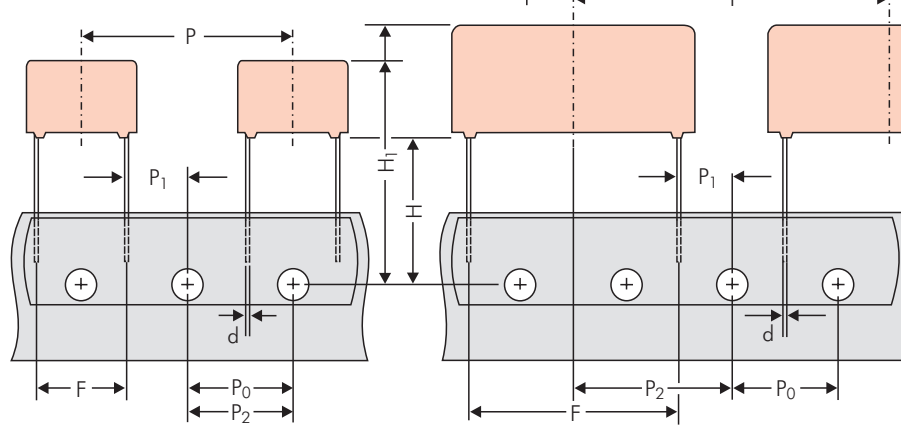

Diagram 2: PCM 10/15 mm

Diagram 3: PCM 22.5 and 27.5*mm

*PCM 27.5 taping possible with two feed holes between components

| Designation | Symbol | Dimensions for radial taping | | | | | | | |
|--|----------------|--|--|---|---|---|---|--|---|
| | | PCM 2.5 taping | PCM 5 taping | PCM 7.5 taping | PCM 10 taping* | PCM 15 taping* | PCM 22.5 taping | PCM 27.5 taping | |
| Carrier tape width | W | 18.0 ±0.5 | 18.0 ±0.5 | 18.0 ±0.5 | 18.0 ±0.5 | 18.0 ±0.5 | 18.0 ±0.5 | 18.0 ±0.5 | |
| Hold-down tape width | W ₀ | 6.0 for hot-sealing adhesive tape | 6.0 for hot-sealing adhesive tape | 12.0 for hot-sealing adhesive tape | 12.0 for hot-sealing adhesive tape | 12.0 for hot-sealing adhesive tape | 12.0 for hot-sealing adhesive tape | 12.0 for hot-sealing adhesive tape | |
| Hole position | W ₁ | 9.0 ±0.5 | 9.0 ±0.5 | 9.0 ±0.5 | 9.0 ±0.5 | 9.0 ±0.5 | 9.0 ±0.5 | 9.0 ±0.5 | |
| Hold down tape position | W ₂ | 0.5 to 3.0 max. | 0.5 to 3.0 max. | 0.5 to 3.0 max. | 0.5 to 3.0 max. | 0.5 to 3.0 max. | 0.5 to 3.0 max. | 0.5 to 3.0 max. | |
| Feed hole diameter | D ₀ | 4.0 ±0.2 | 4.0 ±0.2 | 4.0 ±0.2 | 4.0 ±0.2 | 4.0 ±0.2 | 4.0 ±0.2 | 4.0 ±0.2 | |
| Pitch of component | P | 12.7 ±1.0 | 12.7 ±1.0 | 12.7 ±1.0 | 25.4 ±1.0 | 25.4 ±1.0 | 38.1 ±1.5 | 38.1 ±1.5 or 50.8 ±1.5 | |
| Feed hole pitch | P ₀ | 12.7 ±0.3 cumulative pitch error max. 1.0 mm/20 pitch | 12.7 ±0.3 cumulative pitch error max. 1.0 mm/20 pitch | 12.7 ±0.3 cumulative pitch error max. 1.0 mm/20 pitch | 12.7 ±0.3 cumulative pitch error max. 1.0 mm/20 pitch | 12.7 ±0.3 cumulative pitch error max. 1.0 mm/20 pitch | 12.7 ±0.3 cumulative pitch error max. 1.0 mm/20 pitch | 12.7 ±0.3 cumulative pitch error max. 1.0 mm/20 pitch | |
| Feed hole centre to lead | P ₁ | 5.1 ±0.5 | 3.85 ±0.7 | 2.6 ±0.7 | 7.7 ±0.7 | 5.2 ±0.7 | 7.8 ±0.7 | 5.3 ±0.7 | |
| Hole centre to component centre | P ₂ | 6.35 ±1.3 | 6.35 ±1.3 | 6.35 ±1.3 | 12.7 ±1.3 | 12.7 ±1.3 | 19.05 ±1.3 | 19.05 ±1.3 | |
| Feed hole centre to bottom edge of the component | H _▲ | 16.5 ±0.3 18.5 ±0.5 | 16.5 ±0.3 18.5 ±0.5 | 16.5 ±0.5 18.5 ±0.5 | 16.5 ±0.5 18.5 ±0.5 | 16.5 ±0.5 18.5 ±0.5 | 16.5 ±0.5 18.5 ±0.5 | 16.5 ±0.5 18.5 ±0.5 | |
| Feed hole centre to top edge of component | H ₁ | H+H _{component} < H ₁ 32.25 max. | H+H _{component} < H ₁ 32.25 max. | H+H _{component} < H ₁ 24.5 to 31.5 | H+H _{component} < H ₁ 25.0 to 31.5 | H+H _{component} < H ₁ 26.0 to 37.0 | H+H _{component} < H ₁ 30.0 to 43.0 | H+H _{component} < H ₁ 35.0 to 45.0 | |
| Lead spacing at upper edge of carrier tape | F | 2.5 ±0.5 | 5.0 ^{+0.8} _{-0.2} | 7.5 ±0.8 | 10.0 ±0.8 | 15 ±0.8 | 22.5 ±0.8 | 27.5 ±0.8 | |
| Lead diameter | d | 0.4 ±0.05 | 0.5 ±0.05 | •0.5 ±0.05 or 0.7 ^{+0.07} _{-0.05} | •0.5 ±0.05 or 0.7 ^{+0.07} _{-0.05} | 0.8 ^{+0.08} _{-0.05} | 0.8 ^{+0.08} _{-0.05} | •0.8 ^{+0.08} _{-0.05} or 1.0 ^{+0.1} _{-0.05} | |
| Component alignment | Δh | ± 2.0 max. | ± 2.0 max. | ± 3.0 max. | ± 3.0 max. | ± 3.0 max. | ± 3.0 max. | ± 3.0 max. | |
| Total tape thickness | t | 0.7 ±0.2 | 0.7 ±0.2 | 0.7 ±0.2 | 0.7 ±0.2 | 0.7 ±0.2 | 0.7 ±0.2 | 0.7 ±0.2 | |
| Package (see also page 14) | ▲ | ROLL/AMMO | | | AMMO | | | | |
| | | REEL ø 360 max. ø 30 ±1 | B 52 ±2 58 ±2 | } depending on comp. dimensions | REEL ø 360 max. ø 30 ±1 | B 52 ±2 58 ±2 66 ±2 | or REEL ø 500 max. ø 25 ±1 | B 54 ±2 60 ±2 68 ±2 | } depending on PCM and component dimensions |
| Unit | | see details page 76. | | | | | | | |

▲ Please give „H“ dimensions and desired packaging type when ordering.

Dims in mm.

• Diameter of leads see General Data.

Please clarify customer-specific deviations with the manufacturer.

* PCM 10 and PCM 15 can be crimped to PCM 7.5.

Position of components according to PCM 7.5 (sketch 11). P₀ = 12.7 or 15.0 is possible.

Gurt-Verpackungsarten für Kondensatoren mit radialen Anschlüssen

Types of tape packaging of capacitors for automatic radial insertion

■ Rollenverpackung ROLL ROLL packaging

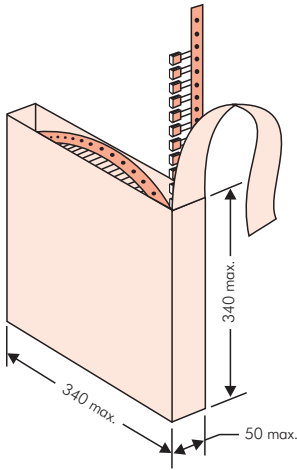

■ Lagenverpackung AMMO AMMO packaging

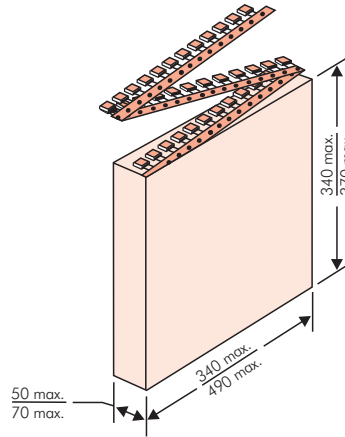

■ Trommelverpackung REEL REEL packaging

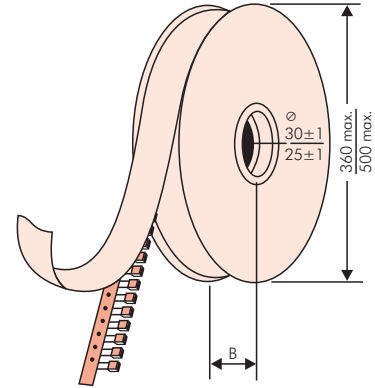

BAR CODE

Etikettierung der Verpackungseinheiten klartextlich und mit alphanumerischem Strichcode

Scanner-Decodierung von

- WIMA-Lieferernummer
- Kunden-Bestellnummer
- Kunden-Sachnummer
- WIMA-Bezeichnung
 - Artikel
 - Kapazitätswert
 - Kapazitätstoleranz
 - Nennspannung
 - Abmessungen
- WIMA-Kommissionsnummer
- Stückzahl

Zusätzlich in Klartext Lieferdatum und Kundename

BAR CODE „Code 39“

| | | | |
|---|--|---------------------------|--|
| WIMA Kondensatoren | | Made in Germany | |
| | | Werk Aurich | |
| | | 26.07.00-30/31 | |
| Lieferer-Nr.: ... | | | |
| Bestell-Nr.: ... | | | |
| Sach-Nr.: ... | | | |
| MKS-4 2.2 µF 20% 100 V- 6x15x26.5 RM 10 | | | |
| Komm-Nr.: ... | | WIMA Kondensatoren | |
| | | MKS-4 | |
| | | 2.2 µF 20% 100 V- | |
| | | 6x15x26.5 RM 22.5 | |
| Stück: ... | | Kunde: ... | |
| | | 26.07.00-30/31 | |

Labelling of package units in plain text and with alphanumerical Bar Code

Scanner decoding of

- WIMA supplier number
- Customer's P/O number
- Customer's part number
- WIMA description
 - article
 - capacitance value
 - capacitance tolerance
 - rated voltage
 - dimensions
- WIMA acknowledgement number
- Quantity

In addition date of delivery and customer's name in plain text