

## RF Power Pot Capacitors for Dielectric Heating Equipment, R16 HQ Ceramic Dielectric



QUICK REFERENCE DATA		
DESCRIPTION	VALUE	
Ceramic Class	1	
Ceramic Dielectric	R16 HQ	
Type	TDFZ 125213 TDFZ 125236	TDFZ 125260
Voltage ( $V_p$ )	18 000	12 000
Min. Capacitance (pF)	500	1500
Max. Capacitance (pF)	1000	2000
Mounting	Screw terminal	

### MATERIAL

Capacitor elements made from Class 1 ceramic dielectric with noble metal electrodes.

Connection terminals:

Made from copper/brass, silver plated

### FINISH

Capacitor body completely protective laquered  
These capacitors feature umbrella-shaped insulation rims made from silicone elastomer to minimize the adverse effects of moisture, dust and other impurities in the working environment and to improve the characteristics of the electrical field.

### MARKING

Type designator, capacitance value and tolerance, rated peak voltage, ceramic material code, production date code, manufacturer logo.

### FEATURES

These capacitors feature a Q-factor of greater than 10 000 which makes them ideal in operating frequency range from 0.1 MHz up to 30 MHz where high voltages and currents are present. The TDZ model can be used as replacements for fixed vacuum capacitors. The construction gives these capacitors an advantage over fixed vacuum capacitors because there is no possibility of vacuum deterioration.

### APPLICATIONS

Dielectric heating equipments in industrial segment.

### CAPACITANCE RANGE

500 pF to 2000 pF

### CAPACITANCE TOLERANCE

$\pm 10 \%$

### CERAMIC DIELECTRICS

R16 High Q (TCC + 100 ppm/K)

### RATED VOLTAGE

- 12 kV<sub>p</sub>
- 18 kV<sub>p</sub>

### DIELECTRIC STRENGTH TEST

170 % of rated AC voltage (50 Hz, 5 minutes)

### RF POWER TEST

110 % to 150 % of rated power, for 2.5 minutes in a test generator circuit.

### DISSIPATION FACTOR

Max. 0.025 % (1 MHz)

### INSULATION RESISTANCE

Min. 100 000 M $\Omega$  (at 25 °C)

### OPERATING TEMPERATURE RANGE

- 55 °C to + 100 °C



SAP PART NUMBER AND ELECTRICAL DATA					
PART NUMBER	CERAMIC	CAP. VALUES (pF)	RATED VOLTAGE (kV <sub>P</sub> )	RATED POWER <sup>(1)</sup> (kvar)	RATED CURRENT (A <sub>RMS</sub> )
<b>TYPE TDFZ 125213</b>					
TF125213WN50136CB1	R16 HQ	500	18	max. 2035	max. 160
TF125213WN75136CB1		750		max. 2300	max. 180
TF125213WN10236CB1		1000		max. 2540	max. 200
<b>TYPE TDFZ 125236</b>					
TF125236WN50136CB1	R16 HQ	500	18	max. 2035	max. 160
TF125236WN75136CB1		750		max. 2300	max. 180
TF125236WN10236CB1		1000		max. 2540	max. 200
<b>TYPE TDFZ 125260</b>					
TF125260WF15236CB1	R16 HQ	1500	12	max. 2000	max. 250
TF125260WF20236CB1		2000		max. 2450	max. 290

**Note**

(1) The surface temperature during operation must not exceed + 100 °C

**DIMENSIONS** in millimeters (inches)

**TDFZ 125213, TDFZ 125260**

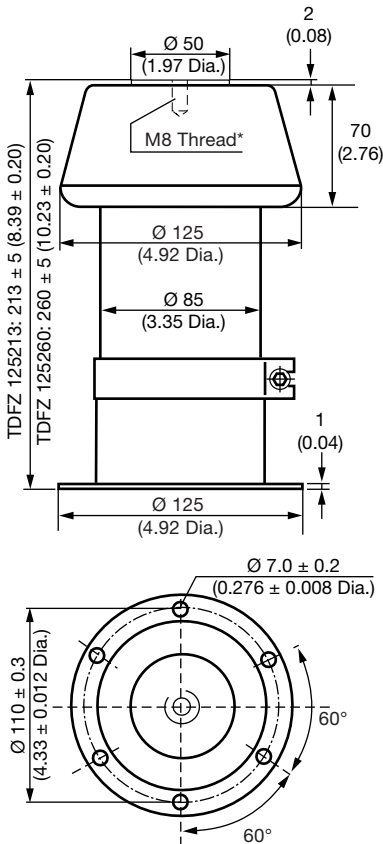

**TDFZ 125236**

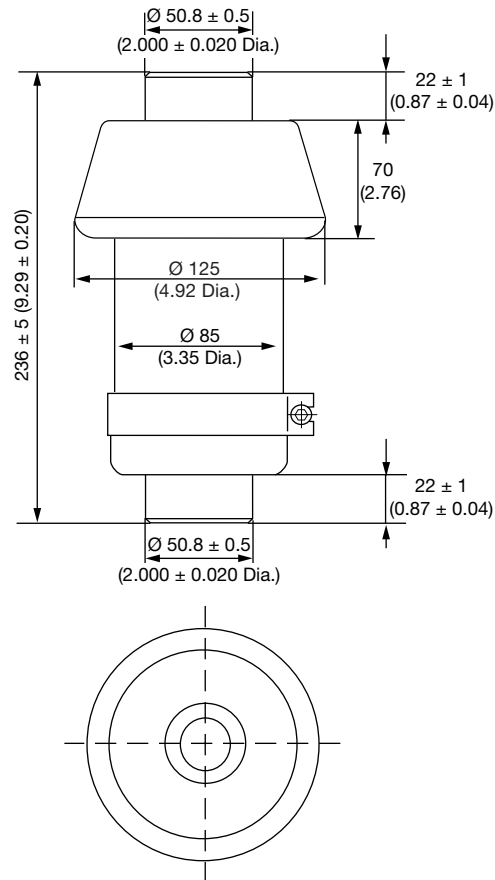

TDFZ 125236 provide solid cylindric brass terminals;  $\varnothing 50.8$  mm (2.000" Dia.)  
This allow plug-in compatible fuse clip mounting for vacuum capacitor replacement



DERATING DIAGRAMS

TF125213WN50136CB1, TF125236WN50136CB1

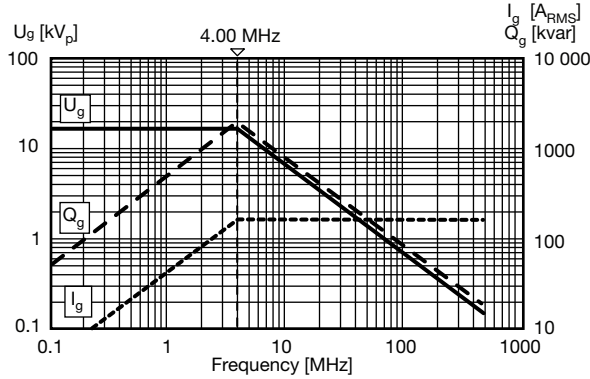

TF125213WN75136CB1, TF125236WN75136CB1

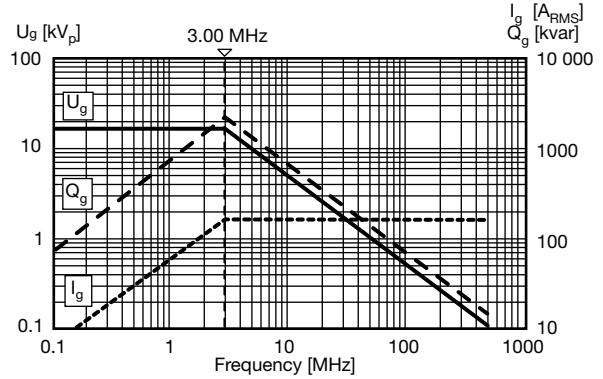

TF125213WN10236CB1, TF125236WN10236CB1

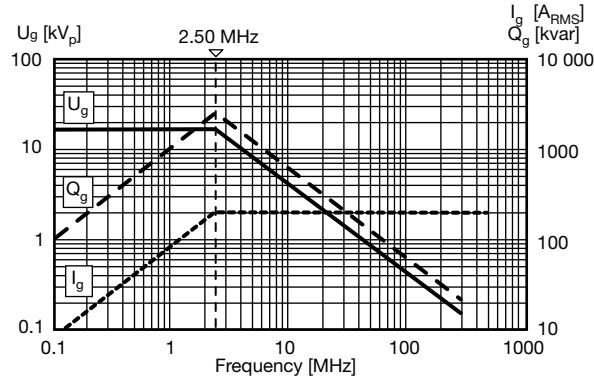

TF125260WF15236CB1

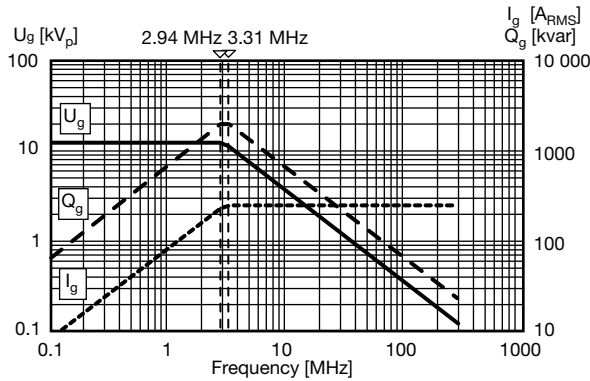

TF125260WF20236CB1

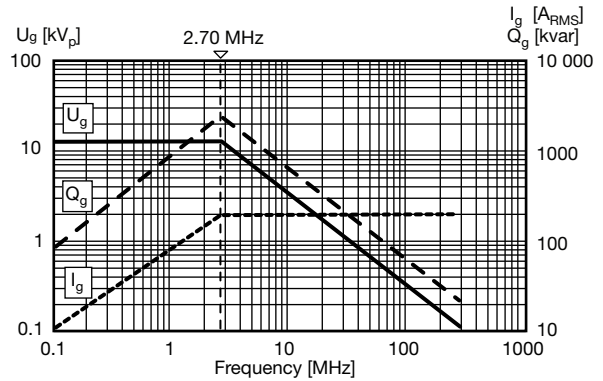



## Disclaimer

ALL PRODUCT, PRODUCT SPECIFICATIONS AND DATA ARE SUBJECT TO CHANGE WITHOUT NOTICE TO IMPROVE RELIABILITY, FUNCTION OR DESIGN OR OTHERWISE.

Vishay Intertechnology, Inc., its affiliates, agents, and employees, and all persons acting on its or their behalf (collectively, "Vishay"), disclaim any and all liability for any errors, inaccuracies or incompleteness contained in any datasheet or in any other disclosure relating to any product.

Vishay makes no warranty, representation or guarantee regarding the suitability of the products for any particular purpose or the continuing production of any product. To the maximum extent permitted by applicable law, Vishay disclaims (i) any and all liability arising out of the application or use of any product, (ii) any and all liability, including without limitation special, consequential or incidental damages, and (iii) any and all implied warranties, including warranties of fitness for particular purpose, non-infringement and merchantability.

Statements regarding the suitability of products for certain types of applications are based on Vishay's knowledge of typical requirements that are often placed on Vishay products in generic applications. Such statements are not binding statements about the suitability of products for a particular application. It is the customer's responsibility to validate that a particular product with the properties described in the product specification is suitable for use in a particular application. Parameters provided in datasheets and/or specifications may vary in different applications and performance may vary over time. All operating parameters, including typical parameters, must be validated for each customer application by the customer's technical experts. Product specifications do not expand or otherwise modify Vishay's terms and conditions of purchase, including but not limited to the warranty expressed therein.

Except as expressly indicated in writing, Vishay products are not designed for use in medical, life-saving, or life-sustaining applications or for any other application in which the failure of the Vishay product could result in personal injury or death. Customers using or selling Vishay products not expressly indicated for use in such applications do so at their own risk. Please contact authorized Vishay personnel to obtain written terms and conditions regarding products designed for such applications.

No license, express or implied, by estoppel or otherwise, to any intellectual property rights is granted by this document or by any conduct of Vishay. Product names and markings noted herein may be trademarks of their respective owners.

## Material Category Policy

**Vishay Intertechnology, Inc. hereby certifies that all its products that are identified as RoHS-Compliant fulfill the definitions and restrictions defined under Directive 2011/65/EU of The European Parliament and of the Council of June 8, 2011 on the restriction of the use of certain hazardous substances in electrical and electronic equipment (EEE) - recast, unless otherwise specified as non-compliant.**

**Please note that some Vishay documentation may still make reference to RoHS Directive 2002/95/EC. We confirm that all the products identified as being compliant to Directive 2002/95/EC conform to Directive 2011/65/EU.**

**Vishay Intertechnology, Inc. hereby certifies that all its products that are identified as Halogen-Free follow Halogen-Free requirements as per JEDEC JS709A standards. Please note that some Vishay documentation may still make reference to the IEC 61249-2-21 definition. We confirm that all the products identified as being compliant to IEC 61249-2-21 conform to JEDEC JS709A standards.**